



COMMONWEALTH OF PENNSYLVANIA
DEPARTMENT OF ENVIRONMENTAL PROTECTION
AIR QUALITY PROGRAM

TITLE V/STATE OPERATING PERMIT

Issue Date: February 16, 2012

Effective Date: February 16, 2012

Expiration Date: January 31, 2017

In accordance with the provisions of the Air Pollution Control Act, the Act of January 8, 1960, P.L. 2119, as amended, and 25 Pa. Code Chapter 127, the Owner, [and Operator if noted] (hereinafter referred to as permittee) identified below is authorized by the Department of Environmental Protection (Department) to operate the air emission source(s) more fully described in this permit. This Facility is subject to all terms and conditions specified in this permit. Nothing in this permit relieves the permittee from its obligations to comply with all applicable Federal, State and Local laws and regulations.

The regulatory or statutory authority for each permit condition is set forth in brackets. All terms and conditions in this permit are federally enforceable applicable requirements unless otherwise designated as "State-Only" or "non-applicable" requirements.

[TITLE V Permit No: 37-00013](#)

Federal Tax Id - Plant Code: 26-3068146-1

Owner Information

Name: CEMEX CONST MATERIALS ATLANTIC LLC
Mailing Address: 2001 PORTLAND PARK
WAMPUM, PA 16157-3913

Plant Information

Plant: CEMEX CONST MATLS ATLANTIC LLC/WAMPUM CEMENT PLT
Location: 37 Lawrence County 37923 Wampum Borough
SIC Code: 3241 Manufacturing - Cement, Hydraulic

Responsible Official

Name: JAMES M CAPALBO
Title: TERMINAL MANAGER
Phone: (724) 535 - 4311

Permit Contact Person

Name: ROBERT J HOCKS
Title: ENVIRONMENTAL MANAGER
Phone: (937) 879 - 8467

[Signature] _____
JOHN F. GUTH, NORTHWEST REGION AIR PROGRAM MANAGER



SECTION A. Table of Contents

Section A. Facility/Source Identification

Table of Contents
Site Inventory List

Section B. General Title V Requirements

- #001 Definitions
- #002 Property Rights
- #003 Permit Expiration
- #004 Permit Renewal
- #005 Transfer of Ownership or Operational Control
- #006 Inspection and Entry
- #007 Compliance Requirements
- #008 Need to Halt or Reduce Activity Not a Defense
- #009 Duty to Provide Information
- #010 Reopening and Revising the Title V Permit for Cause
- #011 Reopening a Title V Permit for Cause by EPA
- #012 Significant Operating Permit Modifications
- #013 Minor Operating Permit Modifications
- #014 Administrative Operating Permit Amendments
- #015 Severability Clause
- #016 Fee Payment
- #017 Authorization for De Minimis Emission Increases
- #018 Reactivation of Sources
- #019 Circumvention
- #020 Submissions
- #021 Sampling, Testing and Monitoring Procedures
- #022 Recordkeeping Requirements
- #023 Reporting Requirements
- #024 Compliance Certification
- #025 Operational Flexibility
- #026 Risk Management
- #027 Approved Economic Incentives and Emission Trading Programs
- #028 Permit Shield

Section C. Site Level Title V Requirements

- C-I: Restrictions
- C-II: Testing Requirements
- C-III: Monitoring Requirements
- C-IV: Recordkeeping Requirements
- C-V: Reporting Requirements
- C-VI: Work Practice Standards
- C-VII: Additional Requirements
- C-VIII: Compliance Certification
- C-IX: Compliance Schedule

Section D. Source Level Title V Requirements

- D-I: Restrictions
- D-II: Testing Requirements
- D-III: Monitoring Requirements
- D-IV: Recordkeeping Requirements
- D-V: Reporting Requirements
- D-VI: Work Practice Standards
- D-VII: Additional Requirements

Note: These same sub-sections are repeated for each source!



SECTION A. Table of Contents

Section E. Source Group Restrictions

- E-I: Restrictions
- E-II: Testing Requirements
- E-III: Monitoring Requirements
- E-IV: Recordkeeping Requirements
- E-V: Reporting Requirements
- E-VI: Work Practice Standards
- E-VII: Additional Requirements

Section F. Alternative Operating Scenario(s)

- F-I: Restrictions
- F-II: Testing Requirements
- F-III: Monitoring Requirements
- F-IV: Recordkeeping Requirements
- F-V: Reporting Requirements
- F-VI: Work Practice Standards
- F-VII: Additional Requirements

Section G. Emission Restriction Summary

Section H. Miscellaneous



SECTION A. Site Inventory List

Source ID	Source Name	Capacity/Throughput		Fuel/Material
101	UNLOAD INTO #4 BELT TRUCK HOPPER	186.000	Tons/HR	RAW MATERIALS
		1.000	Th Tons/HR	STONE/SHALE
103	#4 BELT TO TURN HEAD TRANSFER	186.000	Tons/HR	RAW MATERIALS
104	UNLOAD INTO LIMESTONE PILE	13.000	Tons/HR	LIMESTONE
105	REMOVE FROM LIMESTONE PILE	13.000	Tons/HR	LIMESTONE
106	UNLOAD INTO COAL PILE	15.000	Tons/HR	COAL
107	REMOVE FROM COAL PILE	10.500	Tons/HR	COAL
108	UNLOAD INTO GYPSUM PILE	5.000	Tons/HR	GYPSUM
109	REMOVE FROM GYPSUM PILE	5.000	Tons/HR	GYPSUM
110	UNLOAD INTO #3 BELT TRUCK HOPPER	143.000	Tons/HR	LIMESTONE/SHALE
111	#3 BELT TO TURN HEAD TRANSFER	143.000	Tons/HR	LIMESTONE/SHALE
112	#7 BELT TO #4 SILO TRANSFER	50.000	Tons/HR	CLINKER
113	GYPSUM BELT TO #15 SILO TRANSFER	5.000	Tons/HR	GYPSUM
114	DIVERTER BOX TO #8 BELT TRANSFER	0.250	Tons/HR	GYPSUM
115	TURN HEAD TO #5 SILO TRANSFER	6.000	Tons/HR	LIMESTONE
116	DIVERTER BOX TO LIMESTONE BELT TRANSFER	25.000	Tons/HR	LIMESTONE
117	LIMESTONE BELT TO DIVERTER BOX TRANSFER	50.000	Tons/HR	LIMESTONE
118	DIVERTER BOX TO LIMESTONE BELT TRANSFER	50.000	Tons/HR	LIMESTONE
119	LIMESTONE BELT TO #1 SILO TRANSFER	25.000	Tons/HR	LIMESTONE
120	DIVERTER BOX TO #2 SILO TRANSFER	25.000	Tons/HR	LIMESTONE
121	DIVERTER BOX TO #8 SILO TRANSFER	20.000	Tons/HR	LIMESTONE
122	TURNHEAD TO #7 SILO TRANSFER	20.000	Tons/HR	LIMESTONE
123	TURNHEAD TO #12 SILO TRANSFER	13.000	Tons/HR	LIMESTONE
124	TURNHEAD TO #11 SILO TRANSFER	13.000	Tons/HR	LIMESTONE
125	TURNHEAD TO #10 SILO TRANSFER	13.000	Tons/HR	LIMESTONE
126	DIVERTER BOX TO SHALE BELT TRANSFER	15.000	Tons/HR	SHALE
127	DIVERTER BOX TO SAND BELT TRANSFER	1.600	Tons/HR	SAND/GRAVEL
128	SAND BELT TO #3 SILO TRANSFER	1.600	Tons/HR	SAND/GRAVEL
129	#8 BELT TO #9 BELT TRANSFER	0.250	Tons/HR	GYPSUM
130	#9 BELT TO #6 SILO TRANSFER	0.115	Tons/HR	GYPSUM
131	CLINKER BELT TO CLINKER SILO TRANSFER	32.000	Tons/HR	CLINKER
132	TURNHEAD TO STOKER COAL SILO TRANSFER	0.250	Tons/HR	COAL
133	DIVERTER BOX TO #9 SILO TRANSFER	1.600	Tons/HR	SAND/GRAVEL
134	SHALE BELT TO SHALE SILO TRANSFER	15.000	Tons/HR	SHALE
135	TURNHEAD TO IRON SILO TRANSFER	0.100	Tons/HR	IRON
136	#1 SILO FEEDER	25.000	Tons/HR	LIMESTONE
137	#2 SILO FEEDER	25.000	Tons/HR	LIMESTONE
138	#3 SILO FEEDER	1.600	Tons/HR	SAND/GRAVEL
139	#8 SILO FEEDER	20.000	Tons/HR	LIMESTONE
140	IRON SILO #1 FEEDER	0.050	Tons/HR	IRON



SECTION A. Site Inventory List

Source ID	Source Name	Capacity/Throughput	Fuel/Material
141	IRON SILO #2 FEEDER	0.050 Tons/HR	IRON
142	#6 SILO TRANSFER	0.115 Tons/HR	GYPSUM
143	#7 SILO FEEDER	20.000 Tons/HR	LIMESTONE
144	#12 SILO FEEDER	13.000 Tons/HR	LIMESTONE
145	#11 SILO FEEDER	13.000 Tons/HR	LIMESTONE
146	#10 SILO FEEDER	13.000 Tons/HR	LIMESTONE
147	CLINKER SILO FEEDER	32.000 Tons/HR	CLINKER
148	#9 SILO #1 FEEDER	0.800 Tons/HR	SAND/GRAVEL
149	#9 SILO #2 FEEDER	0.800 Tons/HR	SAND/GRAVEL
150	#7 BELT TO CLINKER SILO TRANSFER	9.000 Tons/HR	CLINKER
151	#5 SILO FEEDER	6.000 Tons/HR	LIMESTONE
152	#1 SHALE FEEDER	5.000 Tons/HR	SHALE
153	#2 SHALE FEEDER	5.000 Tons/HR	SHALE
154	#3 SHALE FEEDER	5.000 Tons/HR	SHALE
155	#1 RAW MILL FEED BELT	45.000 Tons/HR	LIMESTONE,SHALE
156	#2 SHALE BELT TO #2 RAW MILL FEED BELT	5.000 Tons/HR	SHALE
157	#2 RAW MILL FEED BELT	45.000 Tons/HR	LIMESTONE,SHALE
158	#3 SHALE BELT TO #3 RAW MILL FEED BELT	5.000 Tons/HR	SHALE
159	#3 RAW MILL FEED BELT	56.000 Tons/HR	LIMESTONE/SHALE
160	#1 FINISH MILL FEED ELEVATOR	12.000 Tons/HR	CLINKER
161	TURNHEAD TO #5 COAL BELT TRANSFER	70.000 Tons/HR	COAL
162	DIVERTER BOX TO #2 COAL TANK TRANSFER	24.000 Tons/HR	COAL
163	DIVERTER BOX TO COAL BELT TRANSFER	50.000 Tons/HR	COAL
164	COAL BELT TO #1 COAL TANK TRANSFER	24.000 Tons/HR	COAL
165	COAL BELT TO #3 COAL TANK TRANSFER	24.000 Tons/HR	COAL
166	TURNHEAD TO GYPSUM BELT TRANSFER	5.000 Tons/HR	GYPSUM
167	KILN DUST (EARTH PLUS) LOADING	1.000 Tons/HR	EARTH PLUS
168	3101 BELT TO CLINKER PILE TRANSFER	88.000 Tons/HR	CLINKER
		1.000 Tons/HR	CLINKER
169	REMOVAL FROM CLINKER PILE	1.000 Tons/HR	CLINKER
170	GRAVEL BED FILTER DUST TRUCK TRANSFER	0.020 Tons/HR	GBF DUST
171	#3 KILN DUST REFEED	8.000 Tons/HR	ESP DUST
172	#2 FINISH MILL FEED BELT	90.000 Tons/HR	CLINKER/GYPSUM
173	FEEDER TO #1 KILN FEED ELEVATOR TRANSFER	52.000 Tons/HR	RAW MIX/ESPDUST
174	FEEDER TO #2 KILN FEED ELEVATOR TRANSFER	52.000 Tons/HR	RAW MIX/ESPDUST
175	EAST/WEST TRUCK LOADING #1	37.000 Tons/HR	CEMENT
176	EAST/WEST TRUCK LOADING #2	37.000 Tons/HR	CEMENT
177	NEW TRUCK LOADING	12.000 Tons/HR	CEMENT
178	RAIL LOADING	9.000 Tons/HR	CEMENT
179	CLINKER DOME FEEDER TRANSFER	85.000 Tons/HR	CLINKER



SECTION A. Site Inventory List

Source ID	Source Name	Capacity/Throughput		Fuel/Material
180	LIMESTONE PILE	13.000	Tons/HR	LIMESTONE
181	COAL PILE	15.000	Tons/HR	COAL
182	GYPSUM PILE	5.000	Tons/HR	GYPSUM
183	CLINKER PILE	1.000	Tons/HR	CLINKER
184	UNPAVED ROADS	5.000	Miles/HR	VEHICLE MILES
185	PAVED ROADS	21.000	Miles/HR	VEHICLE MILES
186	GASOLINE TANK	6.000	Gal/HR	GASOLINE
187	LARGE TRUCK FUEL TANK	70.000	Gal/HR	#2 FUEL OIL
188	SMALL TRUCK FUEL TANK	70.000	Gal/HR	#2 FUEL OIL
189	KILN LIGHT OFF TANK	7.000	Gal/HR	#2 FUEL OIL
190	DUST SUPPRESSANT TANK	6.000	Gal/HR	DUST SUPPRESS
191	GRINDING AID TANK	7.000	Gal/HR	DIETHYLENE GLYC
192	AIR ENTRAINING AGENT TANK	2.000	Gal/HR	TALL OIL/SOAP
193	USED OIL TANK #1	1.000	Gal/HR	WASTE OIL
194	USED OIL TANK #2	1.000	Gal/HR	WASTE OIL
195	#1 RAW MILL & SEPARATOR	43.000	Tons/HR	RAW MIX
		43.000	Tons/HR	RAW MIX
196	#2 RAW MILL & SEPARATOR	55.000	Tons/HR	RAW MIX
		43.000	Tons/HR	RAW MIX
197	#3 RAW MILL & SEPARATOR	75.000	Tons/HR	RAW MIX
		56.000	Tons/HR	RAW MIX
198	TRANSFER STATION	85.000	Tons/HR	CLINKER
199	3101 BELT & 3102 BELT	32.000	Tons/HR	CLINKER
200	GRAVEL BED FILTER DUST SILO	1.000	Tons/HR	GBF DUST
201	KILN DUST (EARTH PLUS) TANK	1.000	Tons/HR	EARTH PLUS
202	3104 BELT & 3105 BELT	100.000	Tons/HR	CLINKER
		81.000	Tons/HR	CLINKER
203	CLINKER STORAGE BUILDING	100.000	Tons/HR	CLINKER
		86.000	Tons/HR	CLINKER/GBFDUST
204	CLINKER DOME AND TUNNEL	100.000	Tons/HR	CLINKER
		81.000	Tons/HR	CLINKER
205	#1 & #2 KILN FEED ELEVATOR	21.000	Tons/HR	RAW MIX/ESPDUST
206	#1 & #3 HOMOGENIZING SILOS	142.000	Tons/HR	RAW MIX
207	#5 HOMOGENIZING SILO	53.000	Tons/HR	RAW MIX
208	SURGE BIN	90.000	Tons/HR	RAW MIX
209	EAST CEMENT SILOS	40.000	Tons/HR	CEMENT
		47.000	Tons/HR	CEMENT
		150.000	Tons/HR	CEMENT
210	WEST CEMENT SILOS	47.000	Tons/HR	CEMENT
211	#1 - #4 CEMENT SILOS	4.000	Tons/HR	CEMENT
212	MASONRY CEMENT SILO	12.000	Tons/HR	CEMENT



SECTION A. Site Inventory List

Source ID	Source Name	Capacity/Throughput		Fuel/Material
213	SOUTH PACKER	15.000	Tons/HR	CEMENT
214	NORTH PACKER	8.000	Tons/HR	CEMENT
215	MASONRY PACKER	12.000	Tons/HR	CEMENT
216	EAST/WEST TRUCK LOADING	76.000	Tons/HR	CEMENT
217	NEW TRUCK LOADING	12.000	Tons/HR	CEMENT
218	RAILCAR LOADING	9.000	Tons/HR	CEMENT
220	3103 BELT & 3104 BELT	810.000	Tons/HR	CLINKER
221	KILN DUST (EARTH PLUS) SILOS	50.000	Tons/HR	CLINKER DUST
		1.000	Tons/HR	CLINKER DUST
222	#2 FINISH MILL SEPARATOR	90.000	Tons/HR	CLINKER
223	#1 CLINKER COOLER	27.000	Tons/HR	CLINKER
		40.000	Tons/HR	CLINKER
		27.000	Tons/HR	CLINKER
224	#2 CLINKER COOLER	27.000	Tons/HR	CLINKER
		40.000	Tons/HR	CLINKER
		27.000	Tons/HR	CLINKER
225	#3 CLINKER COOLER	32.000	Tons/HR	CLINKER
		40.000	Tons/HR	CLINKER
		32.000	Tons/HR	CLINKER
226	#1 KILN	1.500	Tons/HR	BIOMASS
		27.000	Tons/HR	CLINKER
		6.000	Tons/HR	COAL
		250.000	Gal/HR	#2 FUEL OIL
		6.000	Tons/HR	SPENT ACTIVATED CARBON
		3.600	Tons/HR	VEXOR NON HAZARDOUS
227	#2 KILN	1.500	Tons/HR	BIOMASS
		27.000	Tons/HR	CLINKER
		6.000	Tons/HR	COAL
		250.000	Gal/HR	#2 FUEL OIL
		6.000	Tons/HR	SPENT ACTIVATED CARBON
		3.600	Tons/HR	VEXOR NON HAZARDOUS
228	#3 KILN	1.500	Tons/HR	BIOMASS
		32.000	Tons/HR	CLINKER
		6.000	Tons/HR	COAL
		275.000	Gal/HR	#2 FUEL OIL
		6.000	Tons/HR	SPENT ACTIVATED CARBON
		3.600	Tons/HR	VEXOR NON HAZARDOUS
229	#1 KILN AUXILLIARY MOTOR	1.000	Gal/HR	DIESEL
230	#2 KILN AUXILLIARY MOTOR	1.000	Gal/HR	DIESEL
231	#3 KILN AUXILLIARY MOTOR	1.000	Gal/HR	DIESEL
232	#1 RAW MILL FURNACE	0.125	Tons/HR	BITUMINOUS
		0.125	Tons/HR	BITUMINOUS



SECTION A. Site Inventory List

Source ID	Source Name	Capacity/Throughput	Fuel/Material
233	#2 RAW MILL FURNACE		
234	#1 FINISH MILL & SEPARATOR	12.000 Tons/HR	CEMENT
235	#2 FINISH MILL	90.000 Tons/HR	CEMENT
237	UNLOAD TO SLAG PILE	90.000 Tons/HR	SLAG
238	SLAG PILE	90.000 Tons/HR	SLAG
239	REMOVE FROM SLAG PILE	90.000 Tons/HR	SLAG
240	UNLOAD FROM SLAG HOPPER	90.000 Tons/HR	SLAG
241	SLAG HOPPER TO SLAG BELT 1A TRANSFER	30.000 Tons/HR	SLAG
242	SLAG HOPPER TO SLAG BELT 2A TRANSFER	30.000 Tons/HR	SLAG
243	SLAG HOPPER TO SLAG BELT 3A TRANSFER	30.000 Tons/HR	SLAG
244	SLAG BELT 1A TO SLAG BELT 1B TRANSFER	30.000 Tons/HR	SLAG
245	SLAG BELT 1B TO SLAG BELT 1C TRANSFER	30.000 Tons/HR	SLAG
246	SLAG BELT 2A TO SLAG BELT 2B TRANSFER	30.000 Tons/HR	SLAG
247	SLAG BELT 2B TO SLAG BELT 2C TRANSFER	30.000 Tons/HR	SLAG
248	SLAG BELT 3A TO SLAG BELT 3B TRANSFER	30.000 Tons/HR	SLAG
249	SLAG BELT 3B TO SLAG BELT 3C TRANSFER	30.000 Tons/HR	SLAG
C131	#4 & #13 CLINKER SILO DUST COLLECTOR		
C195	#1 RAW MILL BAGHOUSE		
C196	#2 RAW MILL BAGHOUSE		
C197	#3 RAW MILL BAGHOUSE		
C198A	TRANSFER STATION B.H. (NEW)		
C199A	3101/3102 BELT B.H. (NEW)		
C200	GBF DUST SILO BAGHOUSE		
C201	EARTH PLUS TANK & SILOS BAGHOUSE		
C202A	3104/3105 BELT B.H. (NEW)		
C203	CLINKER STORAGE BUILDING BAGHOUSE		
C204	CLINKER DOME/TUNNEL BAGHOUSE		
C205	#1 & #2 KILN FEED ELEVATOR BAGHOUSE		
C206	#1 & #3 HOMOGENIZING SILOS BAGHOUSE		
C207	#5 HOMO SILO BAGHOUSE		
C208	SURGE BIN BAGHOUSE		
C209	EAST CEMENT SILO BAGHOUSE		
C210	WEST CEMENT SILOS BAGHOUSE		
C211	#1 - #4 CEMENT SILOS BAGHOUSE		
C212	MASONRY SILO BAGHOUSE		
C213	SOUTH PACKER BAGHOUSE		
C214	NORTH PACKER BAGHOUSE		
C215	MASONRY PACKER BAGHOUSE		
C216	EAST/WEST TRUCK LOADING BAGHOUSE		
C217	NEW TRUCK LOADING BAGHOUSE		



SECTION A. Site Inventory List

Source ID	Source Name	Capacity/Throughput	Fuel/Material
C218	RAILCAR LOADING BAGHOUSE		
C220A	3103/3104 BELT B.H. (NEW)		
C221	EARTH PLUS SILO VENT BAGHOUSE		
C222	#2 FINISH MILL SEPARATOR BAGHOUSE		
C223	#1 SETTLING CHAMBER		
C224	#2 SETTLING CHAMBER		
C225	#3 SETTLING CHAMBER		
C226	#1 KILN ESP		
C227	#2 KILN ESP		
C228	#3 KILN ESP		
C234	#1 FINISH MILL BAGHOUSE		
C235	#2 FINISH MILL BAGHOUSE		
C734	WATER SPRAY SYSTEM(J-M)		
C739	AIR SEPARATOR		
C741	SEC. CRUSHER BAGHOUSE		
D223	GRAVEL BED FILTER		
D226	#1 KILN POLISHING ESP		
D227	#2 KILN POLISHING ESP		
D716	AIR SEPARATOR		
FML01	COAL SUPPLY - KILNS		
FML02	#2 "LIGHT-OFF" FUEL OIL		
FML04	PROPANE TANK		
FML06	BIOMASS FUEL		
S113	CON. & RAW SILOS BAGHOUSE S		
S131	#4 & #13 CLINKER SILO D.C. STACK		
S195	#1 RAW MILL B.H. EXHAUST		
S196	#2 RAW MILL B.H. EXHAUST		
S197	#3 RAW MILL B.H. EXHAUST		
S198	TRANSFER STATION B.H. EX.		
S199	3101/3102 BELT B.H. EX.		
S200	GBF DUST SILO B.H. EX.		
S201	KILN DUST TANK B.H. EX.		
S202	3104/3105 BELT B.H. EX.		
S203	CLINKER STORAGE B.H. EX.		
S204	CLINKER DOME TUNNEL B.H.		
S205	#1 & #2 KIL FEED B.H. EX.		
S206	#1 & #3 HOMOGENIZING B.H.		
S207	#5 HOMOGENIZING SILO B.H.		
S208	SURGE BIN B.H. EXHAUST		
S209	EAST SILO B.H. EXHAUST		



SECTION A. Site Inventory List

Source ID	Source Name	Capacity/Throughput	Fuel/Material
S210	WEST SILO B.H. EXHAUST		
S211	#1-#4 SILOS B.H. EXHAUST		
S212	MASONRY SILO B.H. EXHAUST		
S213	SOUTH PACKER B.H. EXHAUST		
S214	NORTH PACKER B.H. EXHAUST		
S215	MASONRY PACKER B.H. EX.		
S216	TRUCK LOADING B.H. EX.		
S217	NEW TRUCK LOAD B.H. EX.		
S218	RAILCAR LOAD B.H. EXHAUST		
S220	3103/3104 BELT B.H. EX.		
S221	KILN DUST SILO B.H. EX.		
S222	#2 FINISH MILL B.H. EX.		
S223	GRAVEL BED FILTER EXHAUST		
S226	CEMENT KILN STACK		
S234	#1 FINISH MILL B.H. EX.		
S235	#2 FINISH MILL B.H. EX.		
Z101	UNLOADING FUGITIVES		
Z102	IMPACTOR TO #4 BELT FUG.		
Z103	#4 BELT TRANSFER FUGITIVE		
Z104	LIMESTONE PILE-UNLOADING		
Z105	LIMESTONE PILE - LOADING		
Z106	COAL PILE - UNLOADING		
Z107	COAL PILE - REMOVAL		
Z108	GYPSUM PILE - UNLOADING		
Z109	GYPSUM PILE - REMOVAL		
Z110	UNLOADING TO #3 BELT FUG		
Z111	#3 BELT TRANSFER FUGITIVE		
Z112	#7 TO #4 BELT TRANS. FUG.		
Z114	DIVERTER BOX TRANS. FUG.		
Z115	TURN HEAD FUGITIVES		
Z116	DIVERTER BOX TRANS. FUG.		
Z117	LIMESTONE BELT TRANS. FUG		
Z118	DIVERTER BOX TRANS. FUG.		
Z119	LIMESTONE BELT TRANS. FUG		
Z120	DIVERTER BOX TRANS. FUG.		
Z121	DIVERTER BOX TRANS. FUG.		
Z122	TURNHEAD TRANS. FUGITIVES		
Z123	TURNHEAD TRANS. FUGITIVES		
Z124	TURNHEAD TRANS. FUGITIVES		
Z125	TURNHEAD TRANS. FUGITIVES		
Z126	DIVERTER BOX TRANS. FUG.		



SECTION A. Site Inventory List

Source ID	Source Name	Capacity/Throughput	Fuel/Material
Z127	DIVERTER BOX TRANS. FUG.		
Z128	SAND BELT TRANSFER FUG.		
Z129	#8 TO #9 BELT TRANS. FUG.		
Z130	#9 TO #6 SILO TRANS. FUG.		
Z132	TURNHEAD TRANS. FUGITIVES		
Z133	DIVERTER BOX TRANS. FUG.		
Z134	SHALE BELT-SILO TRANSFER		
Z135	TURNHEAD TRANS. FUGITIVES		
Z136	#1 SILO FEEDER FUGITIVES		
Z137	#2 SILO FEEDER FUGITIVES		
Z138	#3 SILO FEEDER FUGITIVES		
Z139	#8 SILO FEEDER FUGITIVES		
Z140	IRON SILO #1 FEEDER FUGIT		
Z141	IRON SILO #2 FEEDER FUGIT		
Z142	#6 SILO FEEDER FUGITIVES		
Z143	#7 SILO FEEDER FUGITIVES		
Z144	#12 SILO FEEDER FUGTIVES		
Z145	#11 SILO FEEDER FUGITIVES		
Z146	#10 SILO FEEDER FUGITIVES		
Z147	CLINKER SILO FEEDER FUGIT		
Z148	#9 TO #1 FEEDER FUGITIVES		
Z149	#9 TO #2 FEEDER FUGITIVES		
Z151	#5 SILO FEEDER FUGITIVES		
Z152	#1 SHALE FEEDER FUGITIVES		
Z153	#2 SHALE FEEDER FUGITIVES		
Z154	#3 SHALE FEEDER FUGITIVES		
Z155	#1 RAW MILL FEED FUGITIVE		
Z156	#2 SHAKE BELT FUGITIVES		
Z157	#2 RAW MILL FEED FUGITIVE		
Z158	#3 SHALE BELT TRANS. FUG.		
Z159	#3 RAW MILL FEED FUGITIVE		
Z160	#1 FININSH MILL FEED FUG.		
Z161	TURNHEAD TRANS. FUGITIVES		
Z162	DIVERTER BOX TRANSFER FUG		
Z163	DIVERTER BOX TRANS. FUG.		
Z164	#1 COAL TANK TRANS. FUG.		
Z165	#3 COAL TANK TRANS. FUG.		
Z166	TURNHEAD TRANS. FUGITIVES		
Z167	KILN DUST LOADING FUG.		
Z168	3101 TO CLINKER PILE FUG.		
Z169	CLINKER PILE REMOVAL FUG.		



SECTION A. Site Inventory List

Source ID	Source Name	Capacity/Throughput	Fuel/Material
Z170	GBF DUST TRUCK TRANS. FUG		
Z171	#3 KILN DUST REFEED FUG.		
Z172	#2 FINISH MILL FEED FUG.		
Z173	#1 KILN FEED ELEVATOR FUG		
Z174	#2 KILN FEED ELEVATOR FUG		
Z175	#1 TRUCK LOADING FUGTIVES		
Z176	#2 TRUCK LOADING FUGITIVE		
Z177	NEW TRUCK LOADING FUG.		
Z178	RAIL LOADING FUGITIVES		
Z179	CLINKER DOME TRANS. FUG.		
Z180	LIMESTONE PILE FUGITIVES		
Z181	COAL PILE FUGITIVES		
Z182	GYPSUM PILE FUGITIVES		
Z183	CLINKER PILE FUGITIVES		
Z184	UNPAVED ROAD FUGITIVES		
Z185	PAVED ROADS FUGITIVES		
Z186	GASOLINE TANK FUGITIVES		
Z187	LARGE TRUCK #2 DIESEL FUG		
Z188	SMALL TRUCK #2 DIESEL FUG		
Z189	KILN LIGHT OFF TANK FUG		
Z190	DUST SUPPRESSANT TANK FUG		
Z191	GRINDING AID TANK FUG.		
Z192	AIR ENTRAINING AGENT TANK		
Z193	USED OIL TANK #1 FUGTIVES		
Z194	USED OIL TANK #2 FUGITIVE		
Z229	#1 KILN AUX. MOTOR		
Z230	#2 KILN AUX. MOTOR		
Z231	#3 KILN AUX. MOTOR		
Z237	UNLOAD TO SLAG PILE FUGITIVES		
Z238	SLAG PILE FUGITIVES		
Z239	REMOVE FROM SLAG PILE FUGITIVES		
Z240	UNLOAD TO SLAG HOPPER FUGITIVES		
Z241	SLAG HOPPER TO SLAG BELT 1A FUGITIVES		
Z242	SLAG HOPPER TO SLAG BELT 2A FUGITIVES		
Z243	SLAG HOPPER TO SLAG BELT 3A FUGITIVES		
Z244	SLAG BELT 1A TO SLAG BELT 1B TRANSFER FUGITIVES		
Z245	SLAG BELT 1B TO SLAG BELT 1C TRANSFER FUGITIVES		
Z246	SLAG BELT 2A TO SLAG BELT 2B TRANSFER FUGITIVES		
Z247	SLAG BELT 2B TO SLAG BELT 2C TRANSFER FUGITIVES		



SECTION A. Site Inventory List

Source ID	Source Name	Capacity/Throughput	Fuel/Material
Z248	SLAG BELT 3A TO SLAG BELT 3B TRANSFER FUGITIVES		
Z249	SLAG BELT 3B TO SLAG BELT 3C TRANSFER FUGITIVES		

PERMIT MAPS

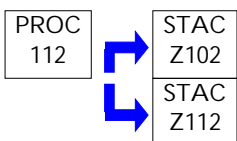
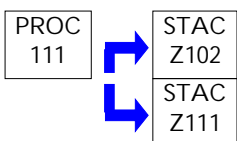
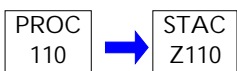
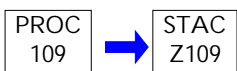
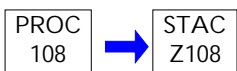
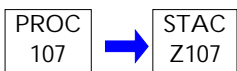
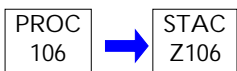
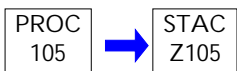
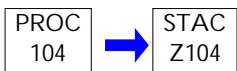
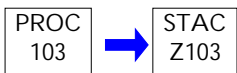
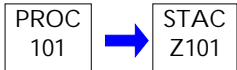

PERMIT MAPS

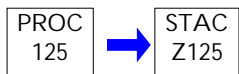
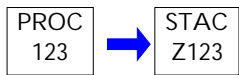
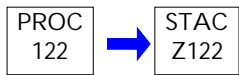
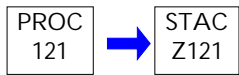
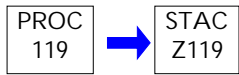
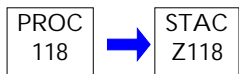
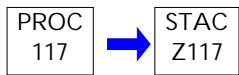
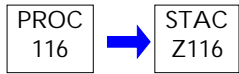
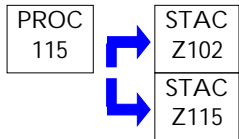
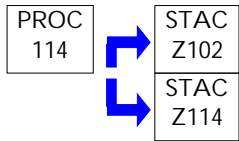
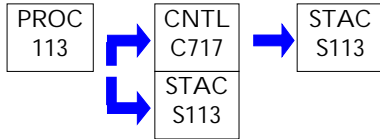



PERMIT MAPS

PROC
126 → STAC
Z126

PROC
127 → STAC
Z127

PROC
128 → STAC
Z128

PROC
129 → STAC
Z129

PROC
130 → STAC
Z130

PROC
131 → CNTL
C131 → STAC
S131

PROC
132 → STAC
Z132

PROC
133 → STAC
Z133

PROC
134 → STAC
Z134

PROC
135 → STAC
Z135

PROC
136 → STAC
Z136

PROC
137 → STAC
Z137

PROC
138 → STAC
Z138

PROC
139 → STAC
Z139

PROC
140 → STAC
Z140



PERMIT MAPS

PROC 141 → STAC Z141

PROC 142 → STAC Z142

PROC 143 → STAC Z143

PROC 144 → STAC Z144

PROC 145 → STAC Z145

PROC 146 → STAC Z146

PROC 147 → STAC Z147

PROC 148 → STAC Z148

PROC 149 → STAC Z149

PROC 150 → CNTL C131 → STAC S131

PROC 151 → STAC Z151

PROC 152 → STAC Z152

PROC 153 → STAC Z153

PROC 154 → STAC Z154

PROC 155 → STAC Z155



PERMIT MAPS

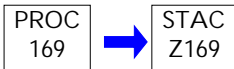
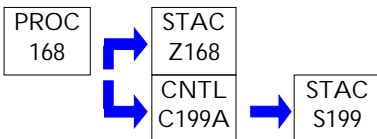
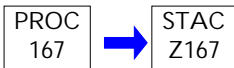
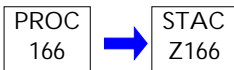
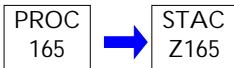
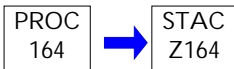
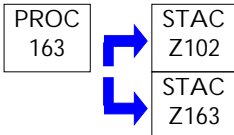
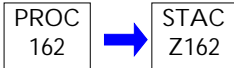
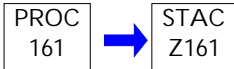
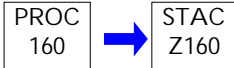
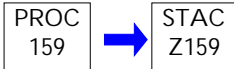
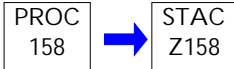
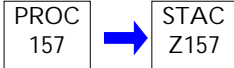
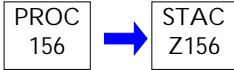

PERMIT MAPS

PROC 170 → STAC Z170

PROC 171 → STAC Z171

PROC 172 → STAC Z172

PROC 173 → STAC Z173

PROC 174 → STAC Z174

PROC 175 → STAC Z175

PROC 176 → STAC Z176

PROC 177 → STAC Z177

PROC 178 → STAC Z178

PROC 179 → STAC Z179

PROC 180 → STAC Z180

PROC 181 → STAC Z181

PROC 182 → STAC Z182

PROC 183 → STAC Z183

PROC 184 → STAC Z184



PERMIT MAPS

PROC 185 → STAC Z185

PROC 186 → STAC Z186

PROC 187 → STAC Z187

PROC 188 → STAC Z188

PROC 189 → STAC Z189

PROC 190 → STAC Z190

PROC 191 → STAC Z191

PROC 192 → STAC Z192

PROC 193 → STAC Z193

PROC 194 → STAC Z194

PROC 195 → CNTL C195 → STAC S195

PROC 196 → CNTL C196 → STAC S196

PROC 197 → CNTL C197 → STAC S197

PROC 198 → CNTL C198A → STAC S198

PROC 199 → CNTL C199A → STAC S199



PERMIT MAPS

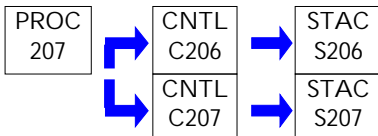
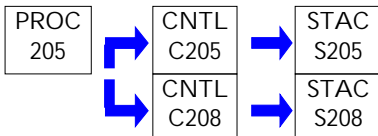
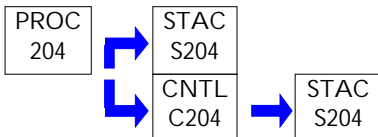
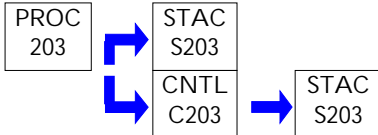



PERMIT MAPS

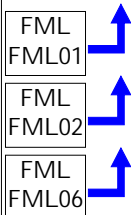
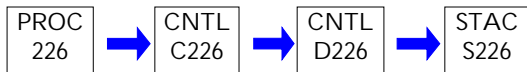
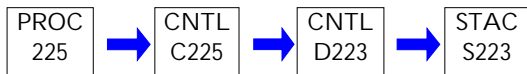
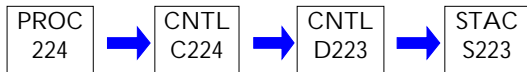
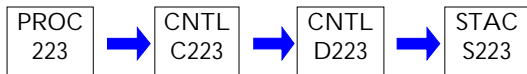

PERMIT MAPS

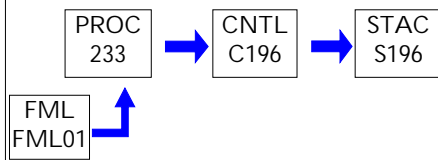
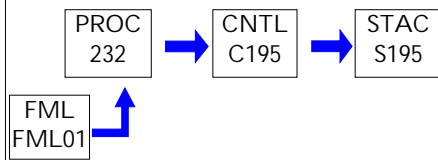
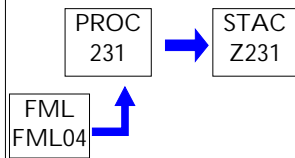
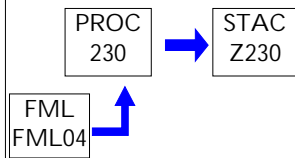
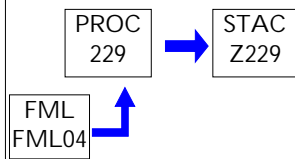
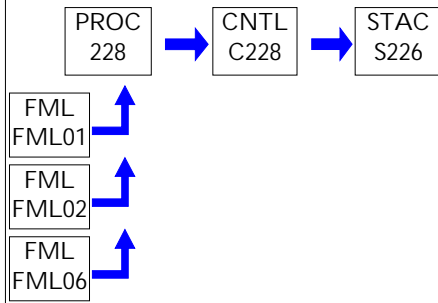
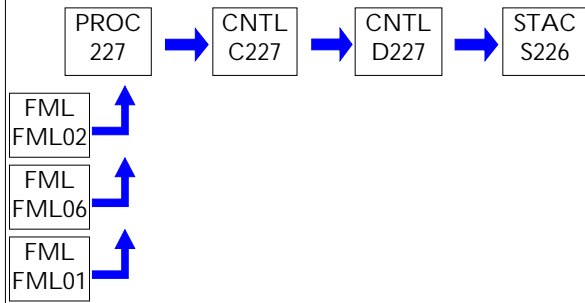

PERMIT MAPS

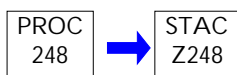
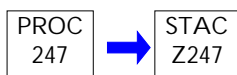
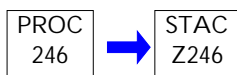
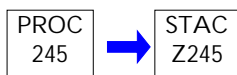
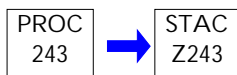
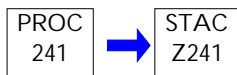
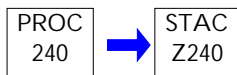
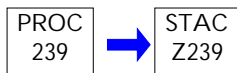
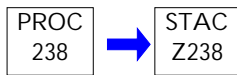
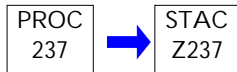
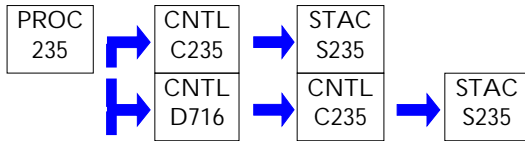
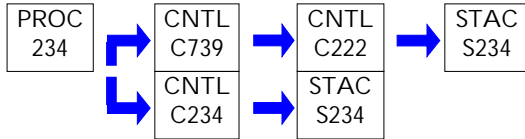



PERMIT MAPS

PROC
249



STAC
Z249



SECTION B. General Title V Requirements

#001 [25 Pa. Code § 121.1]

Definitions

Words and terms that are not otherwise defined in this permit shall have the meanings set forth in Section 3 of the Air Pollution Control Act (35 P.S. § 4003) and 25 Pa. Code § 121.1.

#002 [25 Pa. Code § 127.512(c)(4)]

Property Rights

This permit does not convey property rights of any sort, or any exclusive privileges.

#003 [25 Pa. Code § 127.446(a) and (c)]

Permit Expiration

This operating permit is issued for a fixed term of five (5) years and shall expire on the date specified on Page 1 of this permit. The terms and conditions of the expired permit shall automatically continue pending issuance of a new Title V permit, provided the permittee has submitted a timely and complete application and paid applicable fees required under 25 Pa. Code Chapter 127, Subchapter I and the Department is unable, through no fault of the permittee, to issue or deny a new permit before the expiration of the previous permit. An application is complete if it contains sufficient information to begin processing the application, has the applicable sections completed and has been signed by a responsible official.

#004 [25 Pa. Code §§ 127.412, 127.413, 127.414, 127.446(e) & 127.503]

Permit Renewal

(a) An application for the renewal of the Title V permit shall be submitted to the Department at least six (6) months, and not more than 18 months, before the expiration date of this permit. The renewal application is timely if a complete application is submitted to the Department's Regional Air Manager within the timeframe specified in this permit condition.

(b) The application for permit renewal shall include the current permit number, the appropriate permit renewal fee, a description of any permit revisions and off-permit changes that occurred during the permit term, and any applicable requirements that were promulgated and not incorporated into the permit during the permit term.

(c) The renewal application shall also include submission of proof that the local municipality and county, in which the facility is located, have been notified in accordance with 25 Pa. Code § 127.413. The application for renewal of the Title V permit shall also include submission of compliance review forms which have been used by the permittee to update information submitted in accordance with either 25 Pa. Code § 127.412(b) or § 127.412(j).

(d) The permittee, upon becoming aware that any relevant facts were omitted or incorrect information was submitted in the permit application, shall submit such supplementary facts or corrected information during the permit renewal process. The permittee shall also provide additional information as necessary to address any requirements that become applicable to the source after the date a complete renewal application was submitted but prior to release of a draft permit.

#005 [25 Pa. Code §§ 127.450(a)(4) & 127.464(a)]

Transfer of Ownership or Operational Control

(a) In accordance with 25 Pa. Code § 127.450(a)(4), a change in ownership or operational control of the source shall be treated as an administrative amendment if:

(1) The Department determines that no other change in the permit is necessary;

(2) A written agreement has been submitted to the Department identifying the specific date of the transfer of permit responsibility, coverage and liability between the current and the new permittee; and,

(3) A compliance review form has been submitted to the Department and the permit transfer has been approved by the Department.

(b) In accordance with 25 Pa. Code § 127.464(a), this permit may not be transferred to another person except in cases of transfer-of-ownership which are documented and approved to the satisfaction of the Department.



SECTION B. General Title V Requirements

#006 [25 Pa. Code § 127.513, 35 P.S. § 4008 and § 114 of the CAA]

Inspection and Entry

(a) Upon presentation of credentials and other documents as may be required by law for inspection and entry purposes, the permittee shall allow the Department of Environmental Protection or authorized representatives of the Department to perform the following:

(1) Enter at reasonable times upon the permittee's premises where a Title V source is located or emissions related activity is conducted, or where records are kept under the conditions of this permit;

(2) Have access to and copy or remove, at reasonable times, records that are kept under the conditions of this permit;

(3) Inspect at reasonable times, facilities, equipment including monitoring and air pollution control equipment, practices, or operations regulated or required under this permit;

(4) Sample or monitor, at reasonable times, substances or parameters, for the purpose of assuring compliance with the permit or applicable requirements as authorized by the Clean Air Act, the Air Pollution Control Act, or the regulations promulgated under the Acts.

(b) Pursuant to 35 P.S. § 4008, no person shall hinder, obstruct, prevent or interfere with the Department or its personnel in the performance of any duty authorized under the Air Pollution Control Act.

(c) Nothing in this permit condition shall limit the ability of the EPA to inspect or enter the premises of the permittee in accordance with Section 114 or other applicable provisions of the Clean Air Act.

#007 [25 Pa. Code §§ 127.25, 127.444, & 127.512(c)(1)]

Compliance Requirements

(a) The permittee shall comply with the conditions of this permit. Noncompliance with this permit constitutes a violation of the Clean Air Act and the Air Pollution Control Act and is grounds for one (1) or more of the following:

(1) Enforcement action

(2) Permit termination, revocation and reissuance or modification

(3) Denial of a permit renewal application

(b) A person may not cause or permit the operation of a source, which is subject to 25 Pa. Code Article III, unless the source(s) and air cleaning devices identified in the application for the plan approval and operating permit and the plan approval issued to the source are operated and maintained in accordance with specifications in the applications and the conditions in the plan approval and operating permit issued by the Department. A person may not cause or permit the operation of an air contamination source subject to 25 Pa. Code Chapter 127 in a manner inconsistent with good operating practices.

(c) For purposes of Sub-condition (b) of this permit condition, the specifications in applications for plan approvals and operating permits are the physical configurations and engineering design details which the Department determines are essential for the permittee's compliance with the applicable requirements in this Title V permit. Nothing in this sub-condition shall be construed to create an independent affirmative duty upon the permittee to obtain a predetermination from the Department for physical configuration or engineering design detail changes made by the permittee.

#008 [25 Pa. Code § 127.512(c)(2)]

Need to Halt or Reduce Activity Not a Defense

It shall not be a defense for a permittee in an enforcement action that it would have been necessary to halt or reduce the permitted activity in order to maintain compliance with the conditions of this permit.

#009 [25 Pa. Code §§ 127.411(d) & 127.512(c)(5)]

Duty to Provide Information

(a) The permittee shall furnish to the Department, within a reasonable time, information that the Department may request



SECTION B. General Title V Requirements

in writing to determine whether cause exists for modifying, revoking and reissuing, or terminating the permit, or to determine compliance with the permit.

(b) Upon request, the permittee shall also furnish to the Department copies of records that the permittee is required to keep by this permit, or for information claimed to be confidential, the permittee may furnish such records directly to the Administrator of EPA along with a claim of confidentiality.

#010 [25 Pa. Code §§ 127.463, 127.512(c)(3) & 127.542]

Reopening and Revising the Title V Permit for Cause

(a) This Title V permit may be modified, revoked, reopened and reissued or terminated for cause. The filing of a request by the permittee for a permit modification, revocation and reissuance, or termination, or of a notification of planned changes or anticipated noncompliance does not stay a permit condition.

(b) This permit may be reopened, revised and reissued prior to expiration of the permit under one or more of the following circumstances:

(1) Additional applicable requirements under the Clean Air Act or the Air Pollution Control Act become applicable to a Title V facility with a remaining permit term of three (3) or more years prior to the expiration date of this permit. The Department will revise the permit as expeditiously as practicable but not later than 18 months after promulgation of the applicable standards or regulations. No such revision is required if the effective date of the requirement is later than the expiration date of this permit, unless the original permit or its terms and conditions has been extended.

(2) Additional requirements, including excess emissions requirements, become applicable to an affected source under the acid rain program. Upon approval by the Administrator of EPA, excess emissions offset plans for an affected source shall be incorporated into the permit.

(3) The Department or the EPA determines that this permit contains a material mistake or inaccurate statements were made in establishing the emissions standards or other terms or conditions of this permit.

(4) The Department or the Administrator of EPA determines that the permit must be revised or revoked to assure compliance with the applicable requirements.

(c) Proceedings to revise this permit shall follow the same procedures which apply to initial permit issuance and shall affect only those parts of this permit for which cause to revise exists. The revision shall be made as expeditiously as practicable.

(d) Regardless of whether a revision is made in accordance with (b)(1) above, the permittee shall meet the applicable standards or regulations promulgated under the Clean Air Act within the time frame required by standards or regulations.

#011 [25 Pa. Code § 127.543]

Reopening a Title V Permit for Cause by EPA

As required by the Clean Air Act and regulations adopted thereunder, this permit may be modified, reopened and reissued, revoked or terminated for cause by EPA in accordance with procedures specified in 25 Pa. Code § 127.543.

#012 [25 Pa. Code § 127.541]

Significant Operating Permit Modifications

When permit modifications during the term of this permit do not qualify as minor permit modifications or administrative amendments, the permittee shall submit an application for significant Title V permit modifications in accordance with 25 Pa. Code § 127.541.

#013 [25 Pa. Code §§ 121.1 & 127.462]

Minor Operating Permit Modifications

(a) The permittee may make minor operating permit modifications (as defined in 25 Pa. Code § 121.1) in accordance with 25 Pa. Code § 127.462.

(b) Unless precluded by the Clean Air Act or the regulations thereunder, the permit shield described in 25 Pa. Code §



SECTION B. General Title V Requirements

127.516 (relating to permit shield) shall extend to an operational flexibility change authorized by 25 Pa. Code § 127.462.

#014 [25 Pa. Code § 127.450]

Administrative Operating Permit Amendments

(a) The permittee may request administrative operating permit amendments, as defined in 25 Pa. Code § 127.450(a), according to procedures specified in § 127.450. Administrative amendments are not authorized for any amendment precluded by the Clean Air Act or the regulations thereunder from being processed as an administrative amendment.

(b) Upon taking final action granting a request for an administrative permit amendment in accordance with § 127.450(c), the Department will allow coverage under 25 Pa. Code § 127.516 (relating to permit shield) for administrative permit amendments which meet the relevant requirements of 25 Pa. Code Article III, unless precluded by the Clean Air Act or the regulations thereunder.

#015 [25 Pa. Code § 127.512(b)]

Severability Clause

The provisions of this permit are severable, and if any provision of this permit is determined by the Environmental Hearing Board or a court of competent jurisdiction to be invalid or unenforceable, such a determination will not affect the remaining provisions of this permit.

#016 [25 Pa. Code §§ 127.704, 127.705 & 127.707]

Fee Payment

(a) The permittee shall pay fees to the Department in accordance with the applicable fee schedules in 25 Pa. Code Chapter 127, Subchapter I (relating to plan approval and operating permit fees).

(b) Emission Fees. The permittee shall, on or before September 1st of each year, pay applicable annual Title V emission fees for emissions occurring in the previous calendar year as specified in 25 Pa. Code § 127.705. The permittee is not required to pay an emission fee for emissions of more than 4,000 tons of each regulated pollutant emitted from the facility.

(c) As used in this permit condition, the term "regulated pollutant" is defined as a VOC, each pollutant regulated under Sections 111 and 112 of the Clean Air Act and each pollutant for which a National Ambient Air Quality Standard has been promulgated, except that carbon monoxide is excluded.

(d) Late Payment. Late payment of emission fees will subject the permittee to the penalties prescribed in 25 Pa. Code § 127.707 and may result in the suspension or termination of the Title V permit. The permittee shall pay a penalty of fifty percent (50%) of the fee amount, plus interest on the fee amount computed in accordance with 26 U.S.C.A. § 6621(a)(2) from the date the emission fee should have been paid in accordance with the time frame specified in 25 Pa. Code § 127.705(c).

(e) The permittee shall pay an annual operating permit administration fee according to the fee schedule established in 25 Pa. Code § 127.704(c) if the facility, identified in Subparagraph (iv) of the definition of the term "Title V facility" in 25 Pa. Code § 121.1, is subject to Title V after the EPA Administrator completes a rulemaking requiring regulation of those sources under Title V of the Clean Air Act.

(f) This permit condition does not apply to a Title V facility which qualifies for exemption from emission fees under 35 P.S. § 4006.3(f).

#017 [25 Pa. Code §§ 127.14(b) & 127.449]

Authorization for De Minimis Emission Increases

(a) This permit authorizes de minimis emission increases from a new or existing source in accordance with 25 Pa. Code §§ 127.14 and 127.449 without the need for a plan approval or prior issuance of a permit modification. The permittee shall provide the Department with seven (7) days prior written notice before commencing any de minimis emissions increase that would result from either: (1) a physical change of minor significance under § 127.14(c)(1); or (2) the construction, installation, modification or reactivation of an air contamination source. The written notice shall:



SECTION B. General Title V Requirements

(1) Identify and describe the pollutants that will be emitted as a result of the de minimis emissions increase.

(2) Provide emission rates expressed in tons per year and in terms necessary to establish compliance consistent with any applicable requirement.

The Department may disapprove or condition de minimis emission increases at any time.

(b) Except as provided below in (c) and (d) of this permit condition, the permittee is authorized during the term of this permit to make de minimis emission increases (expressed in tons per year) up to the following amounts without the need for a plan approval or prior issuance of a permit modification:

(1) Four tons of carbon monoxide from a single source during the term of the permit and 20 tons of carbon monoxide at the facility during the term of the permit.

(2) One ton of NO_x from a single source during the term of the permit and 5 tons of NO_x at the facility during the term of the permit.

(3) One and six-tenths tons of the oxides of sulfur from a single source during the term of the permit and 8.0 tons of oxides of sulfur at the facility during the term of the permit.

(4) Six-tenths of a ton of PM₁₀ from a single source during the term of the permit and 3.0 tons of PM₁₀ at the facility during the term of the permit. This shall include emissions of a pollutant regulated under Section 112 of the Clean Air Act unless precluded by the Clean Air Act or 25 Pa. Code Article III.

(5) One ton of VOCs from a single source during the term of the permit and 5.0 tons of VOCs at the facility during the term of the permit. This shall include emissions of a pollutant regulated under Section 112 of the Clean Air Act unless precluded by the Clean Air Act or 25 Pa. Code Article III.

(c) In accordance with § 127.14, the permittee may install the following minor sources without the need for a plan approval:

(1) Air conditioning or ventilation systems not designed to remove pollutants generated or released from other sources.

(2) Combustion units rated at 2,500,000 or less Btu per hour of heat input.

(3) Combustion units with a rated capacity of less than 10,000,000 Btu per hour heat input fueled by natural gas supplied by a public utility, liquefied petroleum gas or by commercial fuel oils which are No. 2 or lighter, viscosity less than or equal to 5.82 c St, and which meet the sulfur content requirements of 25 Pa. Code § 123.22 (relating to combustion units). For purposes of this permit, commercial fuel oil shall be virgin oil which has no reprocessed, recycled or waste material added.

(4) Space heaters which heat by direct heat transfer.

(5) Laboratory equipment used exclusively for chemical or physical analysis.

(6) Other sources and classes of sources determined to be of minor significance by the Department.

(d) This permit does not authorize de minimis emission increases if the emissions increase would cause one or more of the following:

(1) Increase the emissions of a pollutant regulated under Section 112 of the Clean Air Act except as authorized in Subparagraphs (b)(4) and (5) of this permit condition.

(2) Subject the facility to the prevention of significant deterioration requirements in 25 Pa. Code Chapter 127, Subchapter D and/or the new source review requirements in Subchapter E.

(3) Violate any applicable requirement of the Air Pollution Control Act, the Clean Air Act, or the regulations promulgated under either of the acts.



SECTION B. General Title V Requirements

(4) Changes which are modifications under any provision of Title I of the Clean Air Act and emission increases which would exceed the allowable emissions level (expressed as a rate of emissions or in terms of total emissions) under the Title V permit.

(e) Unless precluded by the Clean Air Act or the regulations thereunder, the permit shield described in 25 Pa. Code § 127.516 (relating to permit shield) applies to de minimis emission increases and the installation of minor sources made pursuant to this permit condition.

(f) Emissions authorized under this permit condition shall be included in the monitoring, recordkeeping and reporting requirements of this permit.

(g) Except for de minimis emission increases allowed under this permit, 25 Pa. Code § 127.449, or sources and physical changes meeting the requirements of 25 Pa. Code § 127.14, the permittee is prohibited from making physical changes or engaging in activities that are not specifically authorized under this permit without first applying for a plan approval. In accordance with § 127.14(b), a plan approval is not required for the construction, modification, reactivation, or installation of the sources creating the de minimis emissions increase.

(h) The permittee may not meet de minimis emission threshold levels by offsetting emission increases or decreases at the same source.

#018 [25 Pa. Code §§ 127.11a & 127.215]

Reactivation of Sources

(a) The permittee may reactivate a source at the facility that has been out of operation or production for at least one year, but less than or equal to five (5) years, if the source is reactivated in accordance with the requirements of 25 Pa. Code §§ 127.11a and 127.215. The reactivated source will not be considered a new source.

(b) A source which has been out of operation or production for more than five (5) years but less than 10 years may be reactivated and will not be considered a new source if the permittee satisfies the conditions specified in 25 Pa. Code § 127.11a(b).

#019 [25 Pa. Code §§ 121.9 & 127.216]

Circumvention

(a) The owner of this Title V facility, or any other person, may not circumvent the new source review requirements of 25 Pa. Code Chapter 127, Subchapter E by causing or allowing a pattern of ownership or development, including the phasing, staging, delaying or engaging in incremental construction, over a geographic area of a facility which, except for the pattern of ownership or development, would otherwise require a permit or submission of a plan approval application.

(b) No person may permit the use of a device, stack height which exceeds good engineering practice stack height, dispersion technique or other technique which, without resulting in reduction of the total amount of air contaminants emitted, conceals or dilutes an emission of air contaminants which would otherwise be in violation of this permit, the Air Pollution Control Act or the regulations promulgated thereunder, except that with prior approval of the Department, the device or technique may be used for control of malodors.

#020 [25 Pa. Code §§ 127.402(d) & 127.513(1)]

Submissions

(a) Reports, test data, monitoring data, notifications and requests for renewal of the permit shall be submitted to the:

Regional Air Program Manager
PA Department of Environmental Protection
(At the address given on the permit transmittal letter,
or otherwise notified)

(b) Any report or notification for the EPA Administrator or EPA Region III should be addressed to:

Office of Air Enforcement and Compliance Assistance (3AP20)
United States Environmental Protection Agency
Region 3

**SECTION B. General Title V Requirements**

1650 Arch Street
Philadelphia, PA 19103-2029

(c) An application, form, report or compliance certification submitted pursuant to this permit condition shall contain certification by a responsible official as to truth, accuracy, and completeness as required under 25 Pa. Code § 127.402(d). Unless otherwise required by the Clean Air Act or regulations adopted thereunder, this certification and any other certification required pursuant to this permit shall state that, based on information and belief formed after reasonable inquiry, the statements and information in the document are true, accurate and complete.

#021 [25 Pa. Code §§ 127.441(c) & 127.463(e); Chapter 139; & 114(a)(3), 504(b) of the CAA]

Sampling, Testing and Monitoring Procedures

(a) The permittee shall perform the emissions monitoring and analysis procedures or test methods for applicable requirements of this Title V permit. In addition to the sampling, testing and monitoring procedures specified in this permit, the Permittee shall comply with any additional applicable requirements promulgated under the Clean Air Act after permit issuance regardless of whether the permit is revised.

(b) The sampling, testing and monitoring required under the applicable requirements of this permit, shall be conducted in accordance with the requirements of 25 Pa. Code Chapter 139 unless alternative methodology is required by the Clean Air Act (including §§ 114(a)(3) and 504(b)) and regulations adopted thereunder.

#022 [25 Pa. Code §§ 127.511 & Chapter 135]

Recordkeeping Requirements

(a) The permittee shall maintain and make available, upon request by the Department, records of required monitoring information that include the following:

- (1) The date, place (as defined in the permit) and time of sampling or measurements.
- (2) The dates the analyses were performed.
- (3) The company or entity that performed the analyses.
- (4) The analytical techniques or methods used.
- (5) The results of the analyses.
- (6) The operating conditions as existing at the time of sampling or measurement.

(b) The permittee shall retain records of the required monitoring data and supporting information for at least five (5) years from the date of the monitoring sample, measurement, report or application. Supporting information includes the calibration data and maintenance records and original strip-chart recordings for continuous monitoring instrumentation, and copies of reports required by the permit.

(c) The permittee shall maintain and make available to the Department upon request, records including computerized records that may be necessary to comply with the reporting, recordkeeping and emission statement requirements in 25 Pa. Code Chapter 135 (relating to reporting of sources). In accordance with 25 Pa. Code Chapter 135, § 135.5, such records may include records of production, fuel usage, maintenance of production or pollution control equipment or other information determined by the Department to be necessary for identification and quantification of potential and actual air contaminant emissions. If direct recordkeeping is not possible or practical, sufficient records shall be kept to provide the needed information by indirect means.

#023 [25 Pa. Code §§ 127.411(d), 127.442, 127.463(e) & 127.511(c)]

Reporting Requirements

(a) The permittee shall comply with the reporting requirements for the applicable requirements specified in this Title V permit. In addition to the reporting requirements specified herein, the permittee shall comply with any additional applicable reporting requirements promulgated under the Clean Air Act after permit issuance regardless of whether the permit is revised.



SECTION B. General Title V Requirements

(b) Pursuant to 25 Pa. Code § 127.511(c), the permittee shall submit reports of required monitoring at least every six (6) months unless otherwise specified in this permit. Instances of deviations (as defined in 25 Pa. Code § 121.1) from permit requirements shall be clearly identified in the reports. The reporting of deviations shall include the probable cause of the deviations and corrective actions or preventative measures taken, except that sources with continuous emission monitoring systems shall report according to the protocol established and approved by the Department for the source. The required reports shall be certified by a responsible official.

(c) Every report submitted to the Department under this permit condition shall comply with the submission procedures specified in Section B, Condition #020(c) of this permit.

(d) Any records, reports or information obtained by the Department or referred to in a public hearing shall be made available to the public by the Department except for such records, reports or information for which the permittee has shown cause that the documents should be considered confidential and protected from disclosure to the public under Section 4013.2 of the Air Pollution Control Act and consistent with Sections 112(d) and 114(c) of the Clean Air Act and 25 Pa. Code § 127.411(d). The permittee may not request a claim of confidentiality for any emissions data generated for the Title V facility.

#024 [25 Pa. Code § 127.513]

Compliance Certification

(a) One year after the date of issuance of the Title V permit, and each year thereafter, unless specified elsewhere in the permit, the permittee shall submit to the Department and EPA Region III a certificate of compliance with the terms and conditions in this permit, for the previous year, including the emission limitations, standards or work practices. This certification shall include:

- (1) The identification of each term or condition of the permit that is the basis of the certification.
- (2) The compliance status.
- (3) The methods used for determining the compliance status of the source, currently and over the reporting period.
- (4) Whether compliance was continuous or intermittent.

(b) The compliance certification should be postmarked or hand-delivered within thirty days of each anniversary date of the date of issuance or, of the submittal date specified elsewhere in the permit, to the Department and EPA in accordance with the submission requirements specified in condition #020 of this section.

#025 [25 Pa. Code § 127.3]

Operational Flexibility

(a) The permittee is authorized to make changes within the Title V facility in accordance with the following provisions in 25 Pa. Code Chapter 127 which implement the operational flexibility requirements of Section 502(b)(10) of the Clean Air Act and Section 6.1(i) of the Air Pollution Control Act:

- (1) Section 127.14 (relating to exemptions)
- (2) Section 127.447 (relating to alternative operating scenarios)
- (3) Section 127.448 (relating to emissions trading at facilities with Federally enforceable emissions caps)
- (4) Section 127.449 (relating to de minimis emission increases)
- (5) Section 127.450 (relating to administrative operating permit amendments)
- (6) Section 127.462 (relating to minor operating permit amendments)
- (7) Subchapter H (relating to general plan approvals and operating permits)

(b) Unless precluded by the Clean Air Act or the regulations adopted thereunder, the permit shield authorized under 25 Pa. Code § 127.516 shall extend to operational flexibility changes made at this Title V facility pursuant to this permit



SECTION B. General Title V Requirements

condition and other applicable operational flexibility terms and conditions of this permit.

#026 [25 Pa. Code §§ 127.441(d), 127.512(i) and 40 CFR Part 68]

Risk Management

(a) If required by Section 112(r) of the Clean Air Act, the permittee shall develop and implement an accidental release program consistent with requirements of the Clean Air Act, 40 CFR Part 68 (relating to chemical accident prevention provisions) and the Federal Chemical Safety Information, Site Security and Fuels Regulatory Relief Act (P.L. 106-40).

(b) The permittee shall prepare and implement a Risk Management Plan (RMP) which meets the requirements of Section 112(r) of the Clean Air Act, 40 CFR Part 68 and the Federal Chemical Safety Information, Site Security and Fuels Regulatory Relief Act when a regulated substance listed in 40 CFR § 68.130 is present in a process in more than the listed threshold quantity at the Title V facility. The permittee shall submit the RMP to the federal Environmental Protection Agency according to the following schedule and requirements:

(1) The permittee shall submit the first RMP to a central point specified by EPA no later than the latest of the following:

- (i) Three years after the date on which a regulated substance is first listed under § 68.130; or,
- (ii) The date on which a regulated substance is first present above a threshold quantity in a process.

(2) The permittee shall submit any additional relevant information requested by the Department or EPA concerning the RMP and shall make subsequent submissions of RMPs in accordance with 40 CFR § 68.190.

(3) The permittee shall certify that the RMP is accurate and complete in accordance with the requirements of 40 CFR Part 68, including a checklist addressing the required elements of a complete RMP.

(c) As used in this permit condition, the term "process" shall be as defined in 40 CFR § 68.3. The term "process" means any activity involving a regulated substance including any use, storage, manufacturing, handling, or on-site movement of such substances or any combination of these activities. For purposes of this definition, any group of vessels that are interconnected, or separate vessels that are located such that a regulated substance could be involved in a potential release, shall be considered a single process.

(d) If the Title V facility is subject to 40 CFR Part 68, as part of the certification required under this permit, the permittee shall:

(1) Submit a compliance schedule for satisfying the requirements of 40 CFR Part 68 by the date specified in 40 CFR § 68.10(a); or,

(2) Certify that the Title V facility is in compliance with all requirements of 40 CFR Part 68 including the registration and submission of the RMP.

(e) If the Title V facility is subject to 40 CFR Part 68, the permittee shall maintain records supporting the implementation of an accidental release program for five (5) years in accordance with 40 CFR § 68.200.

(f) When the Title V facility is subject to the accidental release program requirements of Section 112(r) of the Clean Air Act and 40 CFR Part 68, appropriate enforcement action will be taken by the Department if:

(1) The permittee fails to register and submit the RMP or a revised plan pursuant to 40 CFR Part 68.

(2) The permittee fails to submit a compliance schedule or include a statement in the compliance certification required under Condition #24 of Section B of this Title V permit that the Title V facility is in compliance with the requirements of Section 112(r) of the Clean Air Act, 40 CFR Part 68, and 25 Pa. Code § 127.512(i).

#027 [25 Pa. Code § 127.512(e)]

Approved Economic Incentives and Emission Trading Programs

**SECTION B. General Title V Requirements**

No permit revision shall be required under approved economic incentives, marketable permits, emissions trading and other similar programs or processes for changes that are provided for in this Title V permit.

#028 [25 Pa. Code §§ 127.516, 127.450(d), 127.449(f) & 127.462(g)]

Permit Shield

(a) The permittee's compliance with the conditions of this permit shall be deemed in compliance with applicable requirements (as defined in 25 Pa. Code § 121.1) as of the date of permit issuance if either of the following applies:

(1) The applicable requirements are included and are specifically identified in this permit.

(2) The Department specifically identifies in the permit other requirements that are not applicable to the permitted facility or source.

(b) Nothing in 25 Pa. Code § 127.516 or the Title V permit shall alter or affect the following:

(1) The provisions of Section 303 of the Clean Air Act, including the authority of the Administrator of the EPA provided thereunder.

(2) The liability of the permittee for a violation of an applicable requirement prior to the time of permit issuance.

(3) The applicable requirements of the acid rain program, consistent with Section 408(a) of the Clean Air Act.

(4) The ability of the EPA to obtain information from the permittee under Section 114 of the Clean Air Act.

(c) Unless precluded by the Clean Air Act or regulations thereunder, final action by the Department on minor or significant permit modifications, and operational flexibility changes shall be covered by the permit shield. Upon taking final action granting a request for an administrative permit amendment, the Department will allow coverage of the amendment by the permit shield in § 127.516 for administrative amendments which meet the relevant requirements of 25 Pa. Code Article III.

(d) The permit shield authorized under § 127.516 is in effect for the permit terms and conditions in this Title V permit, including administrative operating permit amendments and minor operating permit modifications.



SECTION C. Site Level Requirements

I. RESTRICTIONS.

Emission Restriction(s).

001 [25 Pa. Code §123.1]

Prohibition of certain fugitive emissions

No person may permit the emission into the outdoor atmosphere of fugitive air contaminant from a source other than the following:

- (1) Construction or demolition of buildings or structures.
- (2) Grading, paving and maintenance of roads and streets.
- (3) Use of roads and streets. Emissions from material in or on trucks, railroad cars and other vehicular equipment are not considered as emissions from use of roads and streets.
- (4) Clearing of land.
- (5) Stockpiling of materials.
- (6) Open burning operations.
- (7) Sources and classes of sources other than those identified in paragraphs (1)-(6), for which the operator has obtained a determination from the Department that fugitive emissions from the source, after appropriate control, meet the following requirements:
 - (i) the emissions are of minor significance with respect to causing air pollution; and
 - (ii) the emissions are not preventing or interfering with the attainment or maintenance of any ambient air quality standard.

002 [25 Pa. Code §123.2]

Fugitive particulate matter

A person may not permit fugitive particulate matter to be emitted into the outdoor atmosphere from a source specified in Section C - Condition #001, above, (relating to prohibition of certain fugitive emissions) if such emissions are visible at the point the emissions pass outside the person's property.

003 [25 Pa. Code §123.31]

Limitations

A person may not permit the emission into the outdoor atmosphere of any malodorous air contaminants from any source in such a manner that the malodors are detectable outside the property of the person on whose land the source is being operated.

004 [25 Pa. Code §123.41]

Limitations

A person may not permit the emission into the outdoor atmosphere of visible air contaminants in such a manner that the opacity of the emission is either of the following:

- (1) Equal to or greater than 20% for a period or periods aggregating more than three minutes in any 1 hour.
- (2) Equal to or greater than 60% at any time.

005 [25 Pa. Code §123.42]

Exceptions

The limitations of 123.41 (relating to limitations) shall not apply to a visible emission in any of the following instances:

- (1) when the presence of uncombined water is the only reason for failure of the emission to meet the limitations.
- (2) When the emission results from the operation of equipment used solely to train and test persons in observing the opacity



SECTION C. Site Level Requirements

of visible emissions.

(3) When the emission results from sources specified in Section C - Condition #001, 123.1(a)(1) -- (6) (relating to prohibition of certain fugitive emissions).

II. TESTING REQUIREMENTS.

006 [25 Pa. Code §127.441]

Operating permit terms and conditions.

The Department reserves the right to require exhaust stack testing of any source(s) as necessary to verify emissions for purposes including determining the correct emission fees, malfunctions, or determining compliance with any applicable requirement.

007 [40 CFR Part 63 NESHAPS for Source Categories §40 CFR 63.1352]

Subpart LLL -- National Emission Standards for Hazardous Air Pollutants From the Portland Cement Manufacturing Industry

Additional test methods.

(a) If you are conducting tests to determine the rates of emission of HCl from kilns and associated bypass stacks at portland cement manufacturing facilities, for use in applicability determinations under §63.1340, you may use Method 320 or Method 321 of appendix A of this part.

(b) Owners or operators conducting tests to determine the rates of emission of specific organic HAP from raw material dryers, kilns and in-line kiln/raw mills at Portland cement manufacturing facilities, solely for use in applicability determinations under §63.1340 of this subpart are permitted to use Method 320 of appendix A to this part, or Method 18 of appendix A to part 60 of this chapter.

[75 FR 55063, Sept. 9, 2010]

III. MONITORING REQUIREMENTS.

008 [25 Pa. Code §123.43]

Measuring techniques

Visible emissions may be measured using either of the following:

- (1) A device approved by the Department and maintained to provide accurate opacity measurements.
- (2) Observers, trained and qualified to measure plume opacity with the naked eye or with the aid of any devices approved by the Department.

009 [25 Pa. Code §127.511]

Monitoring and related recordkeeping and reporting requirements.

(a) The permittee shall conduct daily inspections of the areas surrounding the plant to detect the presence of fugitive emissions, visible emissions, and, malodors. A log of these inspections shall be maintained and shall be made available to the Department upon request.

(b) Any fugitive emissions, visible emissions, or malodors that are detected by plant personnel shall be reported to the Shift Supervisor. The Shift Supervisor shall record the event on the maintenance log. Appropriate corrective action shall be taken and noted in the maintenance log.

IV. RECORDKEEPING REQUIREMENTS.

010 [25 Pa. Code §135.5]

Recordkeeping

Source owners or operators shall maintain and make available upon request by the Department records including computerized records that may be necessary to comply with 25 Pa. Code Sections 135.3 and 135.21 (relating to reporting; and emission statements). These may include records of production, fuel usage, maintenance of production or pollution control

SECTION C. Site Level Requirements

equipment or other information determined by the Department to be necessary for identification and quantification of potential and actual air contaminant emissions. If direct recordkeeping is not possible or practical, sufficient records shall be kept to provide the needed information by indirect means.

011 [40 CFR Part 63 NESHAPS for Source Categories §40 CFR 63.10]

Subpart A--General Provisions

Recordkeeping and reporting requirements.

[63.10(b)(2)]

The owner or operator of an affected source subject to the provisions of this part shall maintain relevant records for such source of--

(i) NA;

(ii) NA;

(iii) All required maintenance performed on the air pollution control and monitoring equipment;

(iv) NA;

(v) NA;

(vi) Each period during which a CMS is malfunctioning or inoperative (including out-of-control periods);

(vii) All required measurements needed to demonstrate compliance with a relevant standard (including, but not limited to, 15-minute averages of CMS data, raw performance testing measurements, and raw performance evaluation measurements, that support data that the source is required to report);

(A) This paragraph applies to owners or operators required to install a continuous emissions monitoring system (CEMS) where the CEMS installed is automated, and where the calculated data averages do not exclude periods of CEMS breakdown or malfunction. An automated CEMS records and reduces the measured data to the form of the pollutant emission standard through the use of a computerized data acquisition system. In lieu of maintaining a file of all CEMS subhourly measurements as required under paragraph (b)(2)(vii) of this section, the owner or operator shall retain the most recent consecutive three averaging periods of subhourly measurements and a file that contains a hard copy of the data acquisition system algorithm used to reduce the measured data into the reportable form of the standard.

(B) This paragraph applies to owners or operators required to install a CEMS where the measured data is manually reduced to obtain the reportable form of the standard, and where the calculated data averages do not exclude periods of CEMS breakdown or malfunction. In lieu of maintaining a file of all CEMS subhourly measurements as required under paragraph (b)(2)(vii) of this section, the owner or operator shall retain all subhourly measurements for the most recent reporting period. The subhourly measurements shall be retained for 120 days from the date of the most recent summary or excess emission report submitted to the Administrator.

(C) The Administrator or delegated authority, upon notification to the source, may require the owner or operator to maintain all measurements as required by paragraph (b)(2)(vii), if the administrator or the delegated authority determines these records are required to more accurately assess the compliance status of the affected source.

(viii) All results of performance tests, CMS performance evaluations, and opacity and visible emission observations;

(ix) All measurements as may be necessary to determine the conditions of performance tests and performance evaluations.

V. REPORTING REQUIREMENTS.

012 [25 Pa. Code §135.21]

Emission statements

(a) The owner or operator of each stationary source emitting oxides of nitrogen or VOC's shall provide the Department with a statement, in a form as the Department may prescribe, for classes or categories of sources, showing the actual emissions of oxides of nitrogen and VOCs from that source for each reporting period, a description of the method used to calculate the

**SECTION C. Site Level Requirements**

emissions and the time period over which the calculation is based. The statement shall contain a certification by a company officer or the plant manager that the information contained in the statement is accurate.

(b) Annual emission statements are due by March 1 for the preceding calendar year beginning with March 1, 1993, for calendar year 1992 and shall provide data consistent with requirements and guidance developed by the EPA. The guidance document is available from: United States Environmental Protection Agency, 401 M. Street, S.W., Washington, D.C. 20460. The Department may require more frequent submittals if the Department determines that one or more of the following applies:

- (1) A more frequent submission is required by the EPA.
- (2) Analysis of the data on a more frequent basis is necessary to implement the requirements of the act.

013 [25 Pa. Code §135.3]

Reporting

(a) A person who owns or operates a source to which this chapter applies, and who has previously been advised by the Department to submit a source report, shall submit by March 1 of each year a source report for the preceding calendar year. The report shall include information for all previously reported sources, new sources which were first operated during the preceding calendar year and sources modified during the same period which were not previously reported.

(b) A person who receives initial notification by the Department that a source report is necessary shall submit an initial source report within 60 days after receiving the notification or by March 1 of the year following the year for which the report is required, whichever is later.

(c) A source owner or operator may request an extension of time from the Department for the filing of a source report, and the Department may grant the extension for reasonable cause.

014 [25 Pa. Code §135.4]

Report format

Source reports shall contain sufficient information to enable the Department to complete its emission inventory. Source reports shall be made by the source owner or operator in a format specified by the Department.

015 [40 CFR Part 63 NESHAPS for Source Categories §40 CFR 63.10]

Subpart A--General Provisions**Recordkeeping and reporting requirements.**

The owner or operator shall submit reports to the delegated State authority (which may be the same as the permitting authority) [See Section B, Condition #020]. The owner or operator shall send a copy of each report submitted to the State to the appropriate Regional Office of the EPA (to the attention of Director, Air, Radiation, and Toxics Division, EPA Region III, 1650 Arch Street, Philadelphia, PA 19103-2029. The Regional Office may waive this requirement for any reports at its discretion.

016 [40 CFR Part 63 NESHAPS for Source Categories §40 CFR 63.5]

Subpart A--General Provisions**Construction and reconstruction.**

No person may construct a new affected source or reconstruct an affected source subject to 40 CFR Part 63 Subpart LLL, or reconstruct a source such that the source becomes an affected source subject to the standard, without notifying the Administrator of the intended construction or reconstruction. The notification shall be submitted in accordance with the procedures in 40 CFR 63.9(b) and shall include all the information required for an application for approval of construction or reconstruction as specified in 40 CFR 63.5(d). For major sources, the application for approval of construction or reconstruction may be used to fulfill the notification requirements of this paragraph.

VI. WORK PRACTICE REQUIREMENTS.

017 [25 Pa. Code §123.1]

Prohibition of certain fugitive emissions

A person responsible for any source specified in Section C - Condition #001 of this permit, shall take all reasonable actions to prevent particulate matter from becoming airborne. These actions shall include, but not be limited to, the following:



SECTION C. Site Level Requirements

- (1) Use, where possible, of water or chemicals for control of dust in the demolition of buildings or structures, construction operations, the grading of roads, or the clearing of land.
- (2) Application of asphalt, oil, water or suitable chemicals on dirt roads, material stockpiles and other surfaces which may give rise to airborne dusts.
- (3) Paving and maintenance of roadways.
- (4) Prompt removal of earth or other material from paved streets onto which earth or other material has been transported by trucking or earth moving equipment, erosion by water, or other means.

018 [25 Pa. Code §127.12b]

Plan approval terms and conditions.

Moisture levels shall be maintained in the slag and on roadways to minimize fugitive emissions.

[From Plan Approval 37-013F, Section D, Condition #021]

VII. ADDITIONAL REQUIREMENTS.

019 [25 Pa. Code §127.441]

Operating permit terms and conditions.

§ 63.1356 Sources with multiple emission limits or monitoring requirements.

If an affected facility subject to this subpart has a different emission limit or requirement for the same pollutant under another regulation in title 40 of this chapter, the owner or operator of the affected facility must comply with the most stringent emission limit or requirement and is exempt from the less stringent requirement.

[75 FR 55064, Sept. 9, 2010]

020 [25 Pa. Code §127.441]

Operating permit terms and conditions.

§ 63.1344 Affirmative defense for exceedance of emission limit during malfunction.

In response to an action to enforce the standards set forth in paragraph §63.1343(b) you may assert an affirmative defense to a claim for civil penalties for exceedances of such standards that are caused by malfunction, as defined at 40 CFR 63.2. Appropriate penalties may be assessed, however, if the respondent fails to meet its burden of proving all of the requirements in the affirmative defense. The affirmative defense shall not be available for claims for injunctive relief.

(a) To establish the affirmative defense in any action to enforce such a limit, the owners or operators of facilities must timely meet the notification requirements in paragraph (b) of this section, and must prove by a preponderance of evidence that:

(1) The excess emissions:

(i) Were caused by a sudden, short, infrequent, and unavoidable failure of air pollution control and monitoring equipment, process equipment, or a process to operate in a normal or usual manner, and

(ii) Could not have been prevented through careful planning, proper design or better operation and maintenance practices; and

(iii) Did not stem from any activity or event that could have been foreseen and avoided, or planned for; and

(iv) Were not part of a recurring pattern indicative of inadequate design, operation, or maintenance; and

(2) Repairs were made as expeditiously as possible when the applicable emission limitations were being exceeded. Off-shift and overtime labor were used, to the extent practicable to make these repairs; and



SECTION C. Site Level Requirements

- (3) The frequency, amount and duration of the excess emissions (including any bypass) were minimized to the maximum extent practicable during periods of such emissions; and
- (4) If the excess emissions resulted from a bypass of control equipment or a process, then the bypass was unavoidable to prevent loss of life, severe personal injury, or severe property damage; and
- (5) All possible steps were taken to minimize the impact of the excess emissions on ambient air quality, the environment and human health; and
- (6) All emissions monitoring and control systems were kept in operation if at all possible; and
- (7) Your actions in response to the excess emissions were documented by properly signed, contemporaneous operating logs; and
- (8) At all times, the facility was operated in a manner consistent with good practices for minimizing emissions; and
- (9) The owner or operator has prepared a written root cause analysis to determine, correct, and eliminate the primary causes of the malfunction and the excess emissions resulting from the malfunction event at issue. The analysis shall also specify, using best monitoring methods and engineering judgment, the amount of excess emissions that were the result of the malfunction.
- (b) Notification. The owner or operator of the facility experiencing an exceedance of its emission limit(s) during a malfunction shall notify the Administrator by telephone or facsimile (FAX) transmission as soon as possible, but no later than two business days after the initial occurrence of the malfunction, if it wishes to avail itself of an affirmative defense to civil penalties for that malfunction. The owner or operator seeking to assert an affirmative defense shall also submit a written report to the Administrator within 30 days of the initial occurrence of the exceedance of the standard in §63.1343(b) to demonstrate, with all necessary supporting documentation, that it has met the requirements set forth in paragraph (a) of this section.

[75 FR 55053, Sept. 9, 2010]

021 [25 Pa. Code §127.441]

[Operating permit terms and conditions.](#)

§ 63.1347 Operation and maintenance plan requirements.

- (a) You must prepare, for each affected source subject to the provisions of this subpart, a written operations and maintenance plan. The plan must be submitted to the Administrator for review and approval as part of the application for a part 70 permit and must include the following information:
- (1) Procedures for proper operation and maintenance of the affected source and air pollution control devices in order to meet the emission limits and operating limits of §§63.1343 through 63.1348;
- (2) Corrective actions to be taken when required by paragraph §63.1350(f)(3);
- (3) Procedures to be used during an inspection of the components of the combustion system of each kiln and each in-line kiln raw mill located at the facility at least once per year.
- (b) Failure to comply with any provision of the operations and maintenance plan developed in accordance with this section is a violation of the standard.

[75 FR 55054, Sept. 9, 2010]

022 [25 Pa. Code §127.441]

[Operating permit terms and conditions.](#)

§ 63.1348 Compliance requirements.

This condition only applies to sources regulated by 40 CFR Part 63, Subpart LLL, as indicated in Sections D or E of this permit.



SECTION C. Site Level Requirements

- (a) Initial compliance requirements. For an affected source subject to this subpart, you must demonstrate initial compliance with the emissions standards and operating limits by using the test methods and procedures in §§63.1349 and 63.7.
- (1) PM compliance. If you are subject to limitations on PM emissions under §63.1343(b), you must demonstrate initial compliance with the PM emissions standards by using the test methods and procedures in §63.1349(b)(1).
- (i) You must demonstrate initial compliance by conducting a performance test as specified in §63.1349(b)(1)(i).
- (ii) Compliance with the PM emissions standard must be determined based on the first 30 operating days you operate a PM CEMS.
- (2) Opacity compliance. If you are subject to the limitations on opacity under §63.1345, you must demonstrate initial compliance with the opacity emissions standards by using the performance test methods and procedures in §63.1349(b)(2). The maximum 6-minute average opacity exhibited during the performance test period must be used to determine whether the affected source is in initial compliance with the standard.
- (3) D/F compliance. (i) If you are subject to limitations on D/F emissions under §63.1343(b), you must demonstrate initial compliance with the D/F emissions standards by using the performance test methods and procedures in §63.1349(b)(3). The owner or operator of a kiln with an in-line raw mill must demonstrate initial compliance by conducting separate performance tests while the raw mill is operating and the raw mill is not operating. The D/F concentration must be determined for each run and the arithmetic average of the concentrations measured for the three runs must be calculated to determine compliance.
- (ii) If you are subject to a D/F emission limitation under §63.1343(b), you must demonstrate initial compliance with the temperature operating limits specified in §63.1344 by using the performance test methods and procedures in §63.1349(b)(3)(ii) through (b)(3)(iv). The average of the run temperatures will determine the applicable temperature limit.
- (iii) If activated carbon injection is used and you are subject to a D/F emission limitation under §63.1343(b), you must demonstrate initial compliance with the activated carbon injection rate operating limits specified in §63.1344 by using the performance test methods and procedures in §63.1349(b)(3)(v). The average of the run injection rates will determine the applicable injection rate limit.
- (iv) If activated carbon injection is used, you must also develop a carrier gas parameter during the performance test conducted under §63.1349(b)(3) that meets the requirements of §63.1349(b)(3)(vi). Compliance is demonstrated if the system is maintained within ± 5 percent accuracy during the performance test.
- (4)(i) THC compliance. If you are subject to limitations on THC emissions under §63.1343(b), you must demonstrate initial compliance with the THC emissions standards by using the performance test methods and procedures in §63.1349(b)(4)(i). The average THC concentration obtained during the first 30 operating days must be used to determine initial compliance.
- (ii) Total organic HAP emissions tests. If you elect to demonstrate compliance with the total organic HAP emissions limit under §63.1343(b) in lieu of the THC emissions limit, you must demonstrate initial compliance with the total organic HAP emissions standards by using the performance test methods and procedures in §63.1349(b)(4)(iii) and (b)(4)(iv).
- (iii) If you are demonstrating initial compliance, you must conduct the separate performance tests as specified in §63.1349(b)(4)(iii) while the raw mill kiln is operating and while the raw mill of the kiln is not operating.
- (iv) The average total organic HAP concentration measured during the initial performance test specified by §63.1349(b)(4)(iii) must be used to determine initial compliance.
- (v) The average THC concentration measured during the initial performance test specified by §63.1349(b)(4)(iv) must be used to determine the site-specific THC limit. This limit should be a weighted average of the THC levels measured during raw mill on and raw mill off testing.
- (5) Mercury compliance. If you are subject to limitations on mercury emissions in §63.1343(b), you must demonstrate initial compliance with the mercury standards by using the performance test methods and procedures in §63.1349(b)(5). You must demonstrate initial compliance by operating a mercury CEMS or a sorbent trap based integrated monitor. The first 30 operating days of daily mercury concentration data must be used to determine initial compliance.



SECTION C. Site Level Requirements

- (6) HCl compliance. If you are subject to limitations on HCl emissions under §63.1343(b), you must demonstrate initial compliance with the HCl standards by using the performance test methods and procedures in §63.1349(b)(6).
- (i) For an affected source that is equipped with a wet scrubber or tray tower, you must demonstrate initial compliance by conducting a performance test as specified in §63.1349(b)(6)(i). The HCl concentration must be determined for each run and the arithmetic average of the concentrations measured for the three runs must be calculated to determine compliance. You must also have established appropriate site-specific parameter limits.
- (ii) For an affected source that is not equipped with a wet scrubber or tray tower, you must demonstrate initial compliance by operating a CEMS as specified in §63.1349(b)(6)(ii). The average hourly HCl concentration obtained during the first 30 operating days must be used to determine initial compliance.
- (b) Continuous compliance requirements. You must demonstrate continuous compliance with the emissions standards and operating limits by using the performance test methods and procedures in §§63.1350 and 63.8 for each affected source.
- (1) General requirements. (i) You must monitor and collect data according to §63.1350 and the site-specific monitoring plan required by §63.1350(o).
- (ii) Except for periods of monitoring system malfunctions, repairs associated with monitoring system malfunctions, and required monitoring system quality assurance or quality control activities (including, as applicable, calibration checks and required zero and span adjustments), you must operate the monitoring system and collect data at all required intervals at all times the affected source is operating. Any period for which data collection is required and the operation of the CEMS is not otherwise exempt and for which the monitoring system is out-of-control and data are not available for required calculations constitutes a deviation from the monitoring requirements.
- (iii) You may not use data recorded during monitoring system malfunctions, repairs associated with monitoring system malfunctions, or required monitoring system quality assurance or control activities in calculations used to report emissions or operating levels. A monitoring system malfunction is any sudden, infrequent, not reasonably preventable failure of the monitoring system to provide valid data. Monitoring system failures that are caused in part by poor maintenance or careless operation are not malfunctions. The owner or operator must use all the data collected during all other periods in assessing the operation of the control device and associated control system.
- (iv) Clunker production. If you are subject to limitations on PM emissions (lb/ton of clinker) or mercury (lb/MM tons of clinker) under §63.1343(b), you must demonstrate continuous compliance with the PM emissions standards by determining the hourly production rate of clinker according to the requirements of §63.1350(d).
- (2) PM compliance. If you are subject to limitations on PM emissions under §63.1343(b), you must demonstrate continuous compliance with the PM emissions standards by using the monitoring methods and procedures in §63.1350(b) and (d).
- (i) PM CEMS. You must demonstrate continuous compliance with the PM emissions standards by using the monitoring methods and procedures in §63.1350(b) for each affected source subject to PM emissions limitations. Continuous compliance is demonstrated by a 30-day rolling average PM emissions in lb/ton clinker, except for periods of startup and shutdown, where the compliance is demonstrated based on a 7-day rolling average.
- (3) Opacity compliance. If you are subject to the limitations on opacity under §63.1345, you must demonstrate continuous compliance with the opacity emissions standards by using the monitoring methods and procedures in §63.1350(f).
- (i) Continuous compliance is demonstrated by conducting specified visible emissions observations and follow up opacity readings, as indicated in §63.1350(f)(1) and (f)(2). The maximum 6-minute average opacity exhibited during the performance test period must be used to determine whether the affected source is in compliance with the standard. Corrective actions must be initiated within one hour of detecting visible emissions.
- (ii) COMS. If you install a COMS in lieu of conducting the daily visible emissions testing, you must demonstrate continuous compliance by operating and maintaining the COMS such that it meets the requirements of §63.1350(f)(4)(i).
- (iii) BLDS. If you install a BLDS on a raw mill or finish mill in lieu of conducting the daily visible emissions testing, you must demonstrate continuous compliance by operating and maintaining the BLDS such that it meets the requirements of

**SECTION C. Site Level Requirements**

§63.1350(f)(4)(ii).

(4) D/F compliance. If you are subject to a D/F emission limitation under §63.1343(b), you must demonstrate continuous compliance with the temperature operating limits specified in §63.1346 by using the installing, operating, and maintaining a continuous monitor to record the temperature of specified gas streams such that it meets the requirements of §63.1350(g). Continuous compliance is demonstrated by a 3-hour rolling average temperature.

(5)(i) Activated carbon injection compliance. If activated carbon injection is used and you are subject to a D/F emission limitation under §63.1343(b), you must demonstrate continuous compliance with the activated carbon injection rate operating limits specified in §63.1346 by installing, operating, and maintaining a continuous monitor to record the rate of activated carbon injection that meets the requirements of §63.1350(h)(1). Continuous compliance is demonstrated by a 3-hour rolling average injection rate.

(ii) If you are subject to a D/F emission limitation under §63.1343(b), you must demonstrate continuous compliance with the activated carbon injection system gas parameter by installing, operating, and maintaining a continuous monitor to record the gas parameter that meets the requirements of §63.1350(h)(2). Continuous compliance is demonstrated by a 3-hour rolling average of the parameter value.

(6) THC compliance. If you are subject to limitations on THC emissions under §63.1343(b), you must demonstrate continuous compliance with the THC emissions standards by using the monitoring methods and procedures in §63.1350 (i) and (j). Continuous compliance is demonstrated by a 30-day rolling average THC concentration, except for periods of startup and shutdown, where the standard is based on a 7-day rolling average.

(7) Mercury compliance. If you are subject to limitations on mercury emissions in §63.1343(b), you must demonstrate continuous compliance with the mercury standards by using the monitoring methods and procedures in §63.1350(k). Continuous compliance is demonstrated by a 30-day rolling average mercury emission rate in lb/MM tons clinker, except for periods of startup and shutdown, where the standard is based on a 7-day rolling average mercury concentration.

(8) HCl compliance. If you are subject to limitations on HCl emissions under §63.1343(b), you must demonstrate continuous compliance with the HCl standards by using the performance test methods and procedures in §63.1349(b)(6).

(i) For an affected source that is not equipped with a wet scrubber or tray tower, you must demonstrate continuous compliance by using the monitoring methods and procedures in §63.1350(l)(1). Continuous compliance is demonstrated by a 30-day rolling average HCl concentration, except for periods of startup and shutdown, where the standard is based on a 7-day rolling average.

(ii) For an affected source that is equipped with a wet scrubber or tray tower, you must demonstrate continuous compliance by using the monitoring methods and procedures in §63.1350(l)(2). Continuous compliance is demonstrated by a 30-day rolling average of the required parameters, except for periods of startup and shutdown, where the standard is based on a 7-day rolling average.

(c) Changes in operations. (1) If you plan to undertake a change in operations that may adversely affect compliance with an applicable standard, operating limit, or parametric monitoring value under this subpart, the source must conduct a performance test as specified in §63.1349(b).

(2) In preparation for and while conducting a performance test required in §63.1349(b), you may operate under the planned operational change conditions for a period not to exceed 360 hours, provided that the conditions in (c)(2)(i) through (c)(2)(iv) of this section are met. You must submit temperature and other monitoring data that are recorded during the pretest operations.

(i) You must provide the Administrator written notice at least 60 days prior to undertaking an operational change that may adversely affect compliance with an applicable standard under this subpart for any source, or as soon as practicable where 60 days advance notice is not feasible. Notice provided under this paragraph must include a description of the planned change, the emissions standards that may be affected by the change, and a schedule for completion of the performance test required under paragraph (c)(1) of this section, including when the planned operational change period would begin.

(ii) The performance test results must be documented in a test report according to §63.1349(a).



SECTION C. Site Level Requirements

- (iii) A test plan must be made available to the Administrator prior to performance testing, if requested.
- (iv) The performance test must be conducted completed within 360 hours after the planned operational change period begins.
- (d) General duty to minimize emissions. At all times you must operate and maintain any affected source, including associated air pollution control equipment and monitoring equipment, in a manner consistent with safety and good air pollution control practices for minimizing emissions. Determination of whether such operation and maintenance procedures are being used will be based on information available to the Administrator which may include, but is not limited to, monitoring results, review of operation and maintenance procedures, review of operation and maintenance records, and inspection of the source.

[75 FR 55055, Sept. 9, 2010]

023 [25 Pa. Code §129.14]

Open burning operations

- (a) Air basins. No person may permit the open burning of material in an air basin.
- (b) Not Applicable.
- (c) Exceptions: The requirements of subsections (a) and (b) do not apply where the open burning operations result from:
 - (1) A fire set to prevent or abate a fire hazard, when approved by the Department and set by or under the supervision of a public officer.
 - (2) A fire set for the purpose of instructing personnel in fire fighting, when approved by the Department.
 - (3) A fire set for the prevention and control of disease or pests, when approved by the Department.
 - (4) Not Applicable.
 - (5) Not Applicable.
 - (6) A fire set solely for recreational or ceremonial purposes.
 - (7) A fire set solely for cooking food.
- (d) Clearing and grubbing wastes. The following is applicable to clearing and grubbing wastes:
 - (1) As used in this subsection the following terms shall have the following meanings:

Air curtain destructor -- A mechanical device which forcefully projects a curtain of air across a pit in which open burning is being conducted so that combustion efficiency is increased and smoke and other particulate matter are contained.

Clearing and grubbing wastes -- Trees, shrubs, and other native vegetation which are cleared from land during or prior to the process of construction. The term does not include demolition wastes and dirt laden roots.

 - (2) Subsection (a) notwithstanding, clearing and grubbing wastes may be burned in a basin subject to the following requirements:
 - (i) Air curtain destructors shall be used when burning clearing and grubbing wastes.
 - (ii) Each proposed use of air curtain destructors shall be reviewed and approved by the Department in writing with respect to equipment arrangement, design and existing environmental conditions prior to commencement of burning. Proposals approved under this subparagraph need not obtain plan approval or operating permits under Chapter 127 (relating to construction modification, reactivation and operation of sources).
 - (iii) Approval for use of an air curtain destructor at one site may be granted for a specified period not to exceed 3 months, but may be extended for additional limited periods upon further approval by the Department.



SECTION C. Site Level Requirements

(iv) The Department reserves the right to rescind approval granted if a determination by the Department indicates that an air pollution problem exists.

(3) Not Applicable.

(4) During an air pollution episode, open burning is limited by Chapter 137 (relating to air pollution episodes) and shall cease as specified in such chapter.

024 [40 CFR Part 63 NESHAPS for Source Categories §40 CFR 63.1349]

[Subpart LLL -- National Emission Standards for Hazardous Air Pollutants From the Portland Cement Manufacturing Industry](#)

Performance testing requirements.

This condition only applies to sources regulated by 40 CFR Part 63, Subpart LLL, as indicated in Sections D or E of this permit.

(a) Performance test results must be documented in complete test reports that contain the information required by paragraphs (a)(1) through (a)(10) of this section, as well as all other relevant information. As described in §63.7(c)(2)(i), the site-specific plan to be followed during performance testing must be made available to the Administrator prior to testing, if requested.

(1) A brief description of the process and the air pollution control system;

(2) Sampling location description(s);

(3) A description of sampling and analytical procedures and any modifications to standard procedures;

(4) Test results;

(5) Quality assurance procedures and results;

(6) Records of operating conditions during the performance test, preparation of standards, and calibration procedures;

(7) Raw data sheets for field sampling and field and laboratory analyses;

(8) Documentation of calculations;

(9) All data recorded and used to establish parameters for monitoring; and

(10) Any other information required by the performance test method.

(b)(1) PM emissions tests. (i)(A) If you are subject to the limitations on emissions of PM, you must install, operate, calibrate, and maintain a PM CEMS in accordance with the requirements in §63.1350(b).

(B) You must determine, record, and maintain a record of the accuracy of the volumetric flow rate monitoring system according to the procedures in §63.1350(m)(5).

(C) The initial compliance test must be based on the first 30 operating days in which the affected source operates using a CEMS. Hourly PM concentration and stack gas volumetric flow rate data must be obtained.

(ii) You must determine the clinker production rate using the methods in §63.1350(d).

(iii) The emission rate, E, of PM (lb/ton of clinker) must be computed for each run using equation 3 of 63.1349.

$$E = (CsQs) / (PK)$$

Where:

E = emission rate of particulate matter, lb/ton of clinker production;



SECTION C. Site Level Requirements

Cs= concentration of particulate matter, gr/scf;

Qs= volumetric flow rate of effluent gas, where Cs and Qs are on the same basis (either wet or dry), scf/hr;

P = total kiln clinker production rate, ton/hr; and

K = conversion factor, 7000 gr/lb.

(iv) When there is an alkali bypass associated with a kiln, the main exhaust and alkali bypass of the kiln must be tested simultaneously and the combined emission rate of particulate matter from the kiln and alkali bypass must be computed for each computed for each run using equation 4 of 63.1349.

$$E_c = [(C_{sk}Q_{sk}) + (C_{sb}Q_{sb})] / [KP]$$

Where:

E_c= combined emission rate of particulate matter from the kiln or in-line kiln/raw mill and bypass stack, lb/ton of kiln clinker production;

C_{sk}= concentration of particulate matter in the kiln or in-line kiln/raw mill effluent gas, gr/scf;

Q_{sk}= volumetric flow rate of kiln or in-line kiln/raw mill effluent gas, where C_{sk} and Q_{sk} are on the same basis (either wet or dry), scf/hr;

C_{sb}= concentration of particulate matter in the alkali bypass gas, gr/scf;

Q_{sb}= volumetric flow rate of alkali bypass effluent gas, where C_{sb} and Q_{sb} are on the same basis (either wet or dry), scf/hr;

P = total kiln clinker production rate, ton/hr; and

K = conversion factor, 1000 g/kg (7000 gr/lb).

(2) Opacity tests. If you are subject to limitations on opacity under this subpart, you must conduct opacity tests in accordance with Method 9 of appendix A-4 to part 60 of this chapter. The duration of the Method 9 performance test must be 3 hours (30 6-minute averages), except that the duration of the Method 9 performance test may be reduced to 1 hour if the conditions of paragraphs (b)(2)(i) through (b)(2)(ii) of this section apply. For batch processes that are not run for 3-hour periods or longer, compile observations totaling 3 hours when the unit is operating.

(i) There are no individual readings greater than 10 percent opacity;

(ii) There are no more than three readings of 10 percent for the first 1-hour period.

(3) D/F emissions tests. If you are subject to limitations on D/F emissions under this subpart, you must conduct a performance test using Method 23 of appendix A-7 to part 60 of this chapter. The owner or operator of a kiln or in-line kiln/raw mill equipped with an alkali bypass must conduct simultaneous performance tests of the kiln or in-line kiln/raw mill exhaust and the alkali bypass. However, the owner or operator of an in-line kiln/raw mill may conduct a performance test of the alkali bypass exhaust when the raw mill of the in-line kiln/raw mill is operating or not operating.

(i) Each performance test must consist of three separate runs conducted under representative conditions. The duration of each run must be at least 3 hours, and the sample volume for each run must be at least 2.5 dscm (90 dscf).

(ii) The temperature at the inlet to the kiln or in-line kiln/raw mill PMCD, and, where applicable, the temperature at the inlet to the alkali bypass PMCD must be continuously recorded during the period of the Method 23 test, and the continuous temperature record(s) must be included in the performance test report.



SECTION C. Site Level Requirements

(iii) Hourly average temperatures must be calculated for each run of the performance test.

(iv) The run average temperature must be calculated for each run, and the average of the run average temperatures must be determined and included in the performance test report and will determine the applicable temperature limit in accordance with §63.1344(b).

(v)(A) If sorbent injection is used for D/F control, the rate of sorbent injection to the kiln or in-line kiln/raw mill exhaust, and where applicable, the rate of sorbent injection to the alkali bypass exhaust, must be continuously recorded during the period of the Method 23 test in accordance with the conditions in §63.1350(m)(9), and the continuous injection rate record(s) must be included in the performance test report. Sorbent injection rate parameters must be determined in accordance with paragraphs (b)(3)(vi) of this section.

(B) The performance test report must include the brand and type of sorbent used during the performance test.

(C) The owner or operator must maintain a continuous record of either the carrier gas flow rate or the carrier gas pressure drop for the duration of the performance test. If the carrier gas flow rate is used, the owner or operator must determine, record, and maintain a record of the accuracy of the carrier gas flow rate monitoring system according to the procedures in appendix A to part 75 of this chapter. If the carrier gas pressure drop is used, the owner or operator must determine, record, and maintain a record of the accuracy of the carrier gas pressure drop monitoring system according to the procedures in §63.1350(m)(6).

(vi) The run average sorbent injection rate must be calculated for each run and the average of the run average injection rates must be determined and included in the performance test report and will determine the applicable injection rate limit in accordance with §63.1344(c)(1).

(4)(i) THC CEMS relative accuracy test. (A) If you are subject to limitations on THC emissions, you must operate a continuous emissions monitoring system (CEMS) in accordance with the requirements in §63.1350(1). For the purposes of conducting the accuracy and quality assurance evaluations for CEMS, the THC span value (as propane) is 50 ppmvd. You demonstrate compliance with a RATA when the accuracy between the CEMS and the test audit is within 20 percent or when the test audit results are within 10 percent of the standard

(B) The initial compliance test must be based on the first 30 operating days of operation in which the affected source operates using a CEMS.

(ii) Total organic HAP emissions tests. Instead of conducting the performance test specified in paragraph (b)(4)(i) of this section, you may conduct a performance test to determine emissions of total organic HAP by following the procedures in paragraphs (b)(4)(iii) through (b)(4)(iv) of this section.

(iii) Method 320 of appendix A to this part or ASTM D6348-03 (incorporated by reference - See §63.14) must be used to determine emissions of total organic HAP. Each performance test must consist of three separate runs under the conditions that exist when the affected source is operating at the representative performance conditions in accordance with §63.7(e). Each run must be conducted for at least 1 hour.

(iv) At the same time that you are conducting the performance test for total organic HAP, you must also determine THC emissions by operating a CEMS in accordance with the requirements of §63.1350(j). The duration of the performance test must be 3 hours and the average THC concentration (as calculated from the 1-minute averages) during the 3-hour test must be calculated.

(5) Mercury emissions tests. If you are subject to limitations on mercury emissions, you must operate a mercury CEMS in accordance with the requirements of §63.1350(k). The initial compliance test must be based on the first 30 operating days in which the affected source operates using a CEMS. Hourly mercury concentration and stack gas volumetric flow rate data must be obtained. If you use a sorbent trap monitoring system, daily data must be obtained with each day assumed to equal the daily average of the sorbent trap collection period covering that day.

(i) If you are using a mercury CEMS, you must install, operate, calibrate, and maintain an instrument for continuously measuring and recording the exhaust gas flow rate to the atmosphere according to the requirements in §63.1350(k)(4).

**SECTION C. Site Level Requirements**

(ii) The emission rate must be computed by dividing the average mercury emission rate by the clinker production rate during the same 30-day rolling period using the equation 5 of 63.1349:

$$E = (CsQs) / (PK)$$

Where:

E = emission rate of mercury, lb/million tons of clinker production;

Cs= concentration of mercury, g/scm;

Qs= volumetric flow rate of effluent gas, where Cs and Qs are on the same basis (wet or dry), scm/hr;

P = total kiln clinker production rate, million ton/hr; and

K = conversion factor, 1000 g/kg (454 g/lb).

(6) HCl emissions tests. For a source subject to limitations on HCl emissions you must conduct performance testing by one of the following methods:

(i)(A) If the source is equipped with a wet scrubber, or tray tower, you must conduct performance testing using Method 321 of appendix A to this part unless you have installed a CEMS that meets the requirements §63.1350(l)(1) .

(B) You must establish site specific parameter limits by using the CPMS required in§63.1350(l)(1). Measure and record the pressure drop across the scrubber and/or liquid flow rate and pH in intervals of no more than 15 minutes during the HCl test. Compute and record the 24-hour average pressure drop, pH, and average scrubber water flow rate for each sampling run in which the applicable emissions limit is met.

(ii)(A) If the source is not controlled by a wet scrubber, you must operate a CEMS in accordance with the requirements of §63.1350(l)(1). The initial performance test must be the first 30 operating days you use the CEMS.

(B) The initial compliance test must be based on the 30 operating days in which the affected source operates using a CEMS. Hourly HCl concentration and stack gas volumetric flow rate data must be obtained.

(c) Performance test frequency. Except as provided in §63.1348(b), performance tests are required for affected sources that are subject to a dioxin, total organic HAP, or HCl, emissions limit and must be repeated every 30 months except for pollutants where that specific pollutant is monitored using CEMS.

(d) Performance test reporting requirements.

(1) You must submit the information specified in paragraphs (d)(1)(i) and (d)(2) of this section no later than 60 days following the initial performance test. All reports must be signed by the facility's manager.

(i) The initial performance test data as recorded under paragraph (b) of this section.

(ii) The values for the site-specific operating limits or parameters established pursuant to paragraphs (b)(3), (b)(4)(iii), (b)(5)(ii), and (b)(6)(i) of this section, as applicable, and a description, including sample calculations, of how the operating parameters were established during the initial performance test.

(2) As of December 31, 2011 and within 60 days after the date of completing each performance evaluation or test, as defined in §63.2, conducted to demonstrate compliance with this subpart, you must submit the relative accuracy test audit data and performance test data, except opacity data, to EPA by successfully submitting the data electronically to EPA's Central Data Exchange (CDX) by using the Electronic Reporting Tool(ERT) (see http://www.epa.gov/ttn/chief/ert/ert_tool.html/).

(e) Performance tests must be conducted under such conditions as the Administrator specifies to the owner or operator based on representative performance of the affected source for the period being tested. Upon request, you must make available to

**SECTION C. Site Level Requirements**

the Administrator such records as may be necessary to determine the conditions of performance tests.

[75 FR 55057, Sept. 9, 2010]

025 [40 CFR Part 63 NESHAPS for Source Categories §40 CFR 63.1350]

Subpart LLL -- National Emission Standards for Hazardous Air Pollutants From the Portland Cement Manufacturing Industry

Monitoring requirements.

This condition only applies to sources regulated by 40 CFR Part 63, Subpart LLL, as indicated in Sections D or E of this permit.

(a) All continuous monitoring data for periods of startup and shutdown must be compiled and averaged separately from data gathered during periods of normal operation.

(b) PM monitoring requirements for sources using PM CEMS. (1) For a kiln or clinker cooler subject to emissions limitation on particulate matter emissions in §63.1343(b) and using a PM CEMS, you must install and operate a continuous emissions monitor in accordance with Performance Specification 11 of appendix B and Procedure 2 of appendix F to part 60 of this chapter. The performance test method and the correlation test method for Performance Specification 11 must be Method 5 or Method 5i of appendix A to Part 60 of this chapter. You must also develop an emissions monitoring plan in accordance with paragraphs (o)(1) through (o)(4) of this section.

(2) You must perform Relative Response Audits annually and Response Correlation Audits every 3 years.

(3) If you are using a PM CEMS, you must install, operate, calibrate, and maintain an instrument for continuously measuring and recording the exhaust gas flow rate to the atmosphere according to the requirements in paragraphs (n)(1) through (n)(10) of this section.

(4) In order to calculate the 30-day or 7-day rolling average, collect readings at least every 15 minutes. Sum the hourly data to daily data and then into a 30-day rolling average. You must use all data, except those recorded during monitoring system malfunctions, repairs associated with monitoring system malfunctions, or required monitoring system quality assurance or control activities, in calculations.

(c) [Reserved]

(d) Clinker production monitoring requirements. If you are subject to an emissions limitation on particulate matter, mercury, NOX, or SO₂ emissions (lb/ton of clinker), you must:

(1) Determine hourly clinker production by one of two methods:

(i) Install, calibrate, maintain, and operate a permanent weigh scale system to measure and record weight rates in tons-mass per hour of the amount of clinker produced. The system of measuring hourly clinker production must be maintained within ±5 percent accuracy.

(ii) Install, calibrate, maintain, and operate a permanent weigh scale system to measure and record weight rates in tons-mass per hour of the amount of feed to the kiln. The system of measuring feed must be maintained within ±5 percent accuracy. Calculate your hourly clinker production rate using a kiln specific feed to clinker ratio based on reconciled clinker production determined for accounting purposes and recorded feed rates. This ratio must be updated monthly. Note that if this ratio changes at clinker reconciliation, you must use the new ratio going forward, but you do not have to retroactively change clinker production rates previously estimated.

(2) Determine, record, and maintain a record of the accuracy of the system of measuring hourly clinker production (or feed mass flow if applicable). During each quarter of source operation, you must determine, record, and maintain a record of the ongoing accuracy of the system of measuring hourly clinker production (or feed mass flow).

(3) Record the daily clinker production rates and kiln feed rates; and

(4) Develop an emissions monitoring plan in accordance with paragraphs (o)(1) through (o)(4) of this section.



SECTION C. Site Level Requirements

(e) [Reserved]

(f) Opacity monitoring requirements. If you are subject to a limitation on opacity under §63.1345, you must conduct required emissions monitoring in accordance with the provisions of paragraphs (f)(1)(i) through (f)(1)(vii) of this section and in accordance with the operation and maintenance plan developed in accordance with §63.1347. You must conduct emissions monitoring in accordance with paragraphs (f)(2)(i) through (f)(2)(iii) of this section and in accordance with the operation and maintenance plan developed in accordance with (p)(1) through (p)(4) of this section. You must also develop an opacity emissions monitoring plan in accordance with paragraphs (o)(1) through (o)(4) and paragraph (o)(5), if applicable, of this section.

(1)(i) You must conduct a monthly 10-minute visible emissions test of each affected source in accordance with Method 22 of appendix A-7 to part 60 of this chapter. The performance test must be conducted while the affected source is in operation.

(ii) If no visible emissions are observed in six consecutive monthly tests for any affected source, the owner or operator may decrease the frequency of performance testing from monthly to semi-annually for that affected source. If visible emissions are observed during any semi-annual test, you must resume performance testing of that affected source on a monthly basis and maintain that schedule until no visible emissions are observed in six consecutive monthly tests.

(iii) If no visible emissions are observed during the semi-annual test for any affected source, you may decrease the frequency of performance testing from semi-annually to annually for that affected source. If visible emissions are observed during any annual performance test, the owner or operator must resume performance testing of that affected source on a monthly basis and maintain that schedule until no visible emissions are observed in six consecutive monthly tests.

(iv) If visible emissions are observed during any Method 22 performance test, of appendix A - 7 to part 60 of this chapter, you must conduct five 6-minute averages of opacity in accordance with Method 9 of appendix A - 4 to part 60 of this chapter. The Method 9 performance test, of appendix A - 4 to part 60 of this chapter, must begin within 1 hour of any observation of visible emissions.

(v) The requirement to conduct Method 22 visible emissions monitoring under this paragraph do not apply to any totally enclosed conveying system transfer point, regardless of the location of the transfer point. "Totally enclosed conveying system transfer point" must mean a conveying system transfer point that is enclosed on all sides, top, and bottom. The enclosures for these transfer points must be operated and maintained as total enclosures on a continuing basis in accordance with the facility operations and maintenance plan.

(vi) If any partially enclosed or unenclosed conveying system transfer point is located in a building, you must have the option to conduct a Method 22 performance test, of appendix A - 7 to part 60 of this chapter, according to the requirements of paragraphs (f)(1)(i) through (f)(1)(iv) of this section for each such conveying system transfer point located within the building, or for the building itself, according to paragraph (f)(1)(vii) of this section.

(vii) If visible emissions from a building are monitored, the requirements of paragraphs (f)(1)(i) through (f)(1)(iv) of this section apply to the monitoring of the building, and you must also test visible emissions from each side, roof, and vent of the building for at least 10 minutes.

(2)(i) For a raw mill or finish mill, you must monitor opacity by conducting daily visual emissions observations of the mill sweep and air separator particulate matter control devices (PMCD) of these affected sources in accordance with the procedures of Method 22 of appendix A - 7 to part 60 of this chapter. The duration of the Method 22 performance test must be 6 minutes.

(ii) Within 24 hours of the end of the Method 22 performance test in which visible emissions were observed, the owner or operator must conduct a follow up Method 22 performance test of each stack from which visible emissions were observed during the previous Method 22 performance test.

(iii) If visible emissions are observed during the follow-up Method 22 performance test required by paragraph (a)(5)(ii) of this section from any stack from which visible emissions were observed during the previous Method 22 performance test required by paragraph (a)(5)(i) of the section, you must conduct a visual opacity test of each stack from which emissions were observed during the follow up Method 22 performance test in accordance with Method 9 of appendix A - 4 to part 60 of this chapter. The duration of the Method 9 test must be 30 minutes.



SECTION C. Site Level Requirements

- (3) Corrective actions. If visible emissions are observed during any Method 22 visible emissions test conducted under paragraphs (f)(1) or (f)(2) of this section, you must initiate, within one-hour, the corrective actions specified in the site specific operating and maintenance plan provisions in §63.1347.
- (4) The requirements under paragraph (f)(2) of this section to conduct daily Method 22 testing do not apply to any specific raw mill or finish mill equipped with a continuous opacity monitoring system (COMS) or bag leak detection system (BLDS).
- (i) If the owner or operator chooses to install a COMS in lieu of conducting the daily visual emissions testing required under paragraph (f)(2) of this section, then the COMS must be installed at the outlet of the PM control device of the raw mill or finish mill and the COMS must be installed, maintained, calibrated, and operated as required by the general provisions in subpart A of this part and according to PS - 1 of appendix B to part 60 of this chapter.
- (ii) If you choose to install a BLDS in lieu of conducting the daily visual emissions testing required under paragraph (f)(2) of this section, the requirements in paragraphs (m)(1) through (m)(4), (m)(10) and (m)(11) of this section apply.
- (g) D/F monitoring requirements. If you are subject to an emissions limitation on D/F emissions, you must comply with the monitoring requirements of paragraphs (g)(1) through (g)(6) and paragraphs (m)(1) through (m)(4) of this section to demonstrate continuous compliance with the D/F emissions standard. You must also develop an emissions monitoring plan in accordance with paragraphs (p)(1) through (p)(4) of this section.
- (1) You must install, calibrate, maintain, and continuously operate a continuous monitor to record the temperature of the exhaust gases from the kiln, in-line kiln/raw mill, and alkali bypass, if applicable, at the inlet to, or upstream of, the kiln, in-line kiln/raw mill and/or alkali bypass PMCDs.
- (i) The temperature recorder response range must include zero and 1.5 times the average temperature established according to the requirements in §63.1349(b)(3)(iv).
- (ii) The calibration reference for the temperature measurement must be a National Institute of Standards and Technology calibrated reference thermocouple-potentiometer system or alternate reference, subject to approval by the Administrator.
- (iii) The calibration of all thermocouples and other temperature sensors must be verified at least once every three months.
- (2) You must monitor and continuously record the temperature of the exhaust gases from the kiln, in-line kiln/raw mill, and alkali bypass, if applicable, at the inlet to the kiln, in-line kiln/raw mill and/or alkali bypass PMCD.
- (3) The required minimum data collection frequency must be one minute.
- (4) Each hour, calculate the three-hour average temperature for the previous 3 hours of process operation using all of the one-minute data available (i.e., the CMS is not out-of-control.)
- (5) When the operating status of the raw mill of the in-line kiln/raw mill is changed from off to on or from on to off, the calculation of the three-hour rolling average temperature must begin anew, without considering previous recordings.
- (h) Monitoring requirements for sources using sorbent injection. If you are subject to an operating limit on D/F emissions that employs carbon injection as an emission control technique, you must comply with the additional monitoring requirements of paragraphs (h)(1) and (h)(2) and paragraphs (m)(1) through (m)(4) and (m)(9) of this section. You must also develop an emissions monitoring plan in accordance with paragraphs (p)(1) through (p)(4) of this section.
- (1) Install, operate, calibrate, and maintain a continuous monitor to record the rate of activated carbon injection. The accuracy of the rate measurement device must be ± 1 percent of the rate being measured.
- (i) Verify the calibration of the device at least once every three months.
- (ii) Each hour, calculate the three-hour rolling average activated carbon injection rate for the previous 3 hours of process operation using all of the one-minute data available (i.e., the CMS is not out-of-control.)
- (iii) When the operating status of the raw mill of the in-line kiln/raw mill is changed from off to on or from on to off, the

**SECTION C. Site Level Requirements**

calculation of the three-hour rolling average activated carbon injection rate must begin anew, without considering previous recordings.

(2)(i) Install, operate, calibrate, and maintain a continuous monitor to record the activated carbon injection system carrier gas parameter (either the carrier gas flow rate or the carrier gas pressure drop) established during the D/F performance test in accordance with §63.1349(b)(3).

(ii) Each hour, calculate the three-hour rolling average of the selected parameter value for the previous 3 hours of process operation using all of the one-minute data available (i.e., the CMS is not out-of-control.)

(i) THC Monitoring Requirements. If you are subject to an emissions limitation on THC emissions, you must comply with the monitoring requirements of paragraphs (i)(1) and (i)(2) and (m)(1) through (m)(4) of this section. You must also develop an emissions monitoring plan in accordance with paragraphs (p)(1) through (p)(4) of this section.

(1) You must install, operate, and maintain a THC continuous emission monitoring system in accordance with Performance Specification 8 of appendix B to part 60 of this chapter and comply with all of the requirements for continuous monitoring systems found in the general provisions, subpart A of this part. The owner or operator must operate and maintain each CEMS according to the quality assurance requirements in Procedure 1 of appendix F in part 60 of this chapter.

(2) For sources equipped with an alkali bypass stack, instead of installing a CEMS, you may use the results of the initial or subsequent performance test to demonstrate compliance with the THC emission limit.

(j) Total organic HAP monitoring requirements. If you are complying with the total organic HAP emissions limits, you must continuously monitor THC according to paragraph (i)(1) and (2) or in accordance with Performance Specification 15 of appendix B to part 60 of this chapter and comply with all of the requirements for continuous monitoring systems found in the general provisions, subpart A of this part. You must operate and maintain each CEMS according to the quality assurance requirements in Procedure 1 of appendix F in part 60 of this chapter. In addition, you must follow the monitoring requirements in paragraphs (m)(1) through (m)(4) of this section. You must also develop an emissions monitoring plan in accordance with paragraphs (p)(1) through (p)(4) of this section.

(k) Mercury monitoring requirements. If you have a kiln or in-line kiln/raw mill subject to an emissions limitation on mercury emissions, you must install and operate a mercury continuous emissions monitoring system (Hg CEMS) in accordance with Performance Specification 12A of appendix B to part 60 of this chapter or a sorbent trap-based integrated monitoring system in accordance with Performance Specification 12B of appendix B to part 60 of this chapter. You must continuously monitor mercury according to paragraphs (k)(1) through (k)(3) and (m)(1) through (m)(4) of this section. You must also develop an emissions monitoring plan in accordance with paragraphs (p)(1) through (p)(4) of this section.

(1) The span value for any Hg CEMS must include the intended upper limit of the mercury concentration measurement range during normal "mill on" operation which may be exceeded during "mill off" operation or other short term conditions lasting less than 24 consecutive kiln operating hours. However, the span should be at least equivalent to approximately two times the emissions standard and it may be rounded to the nearest multiple of 10 µg/m³ of total mercury.

(2) You must operate and maintain each Hg CEMS or sorbent trap-based integrated monitoring system according to the quality assurance requirements in Procedure 5 of appendix F to part 60 of this chapter.

(3) Relative accuracy testing of mercury monitoring systems under Performance Specification 12A, Performance Specification 12B, or Procedure 5 must be at normal operating conditions with the raw mill on.

(4) If you use a mercury CEMS, you must install, operate, calibrate, and maintain an instrument for continuously measuring and recording the exhaust gas flow rate to the atmosphere according to the requirements in paragraphs (n)(1) through (n)(10) of this section.

(l) HCl Monitoring Requirements. If you are subject to an emissions limitation on HCl emissions in §63.1343, you must continuously monitor HCl according to paragraph (l)(1) and (2) and paragraphs (m)(1) through (m)(4) of this section. You must also develop an emissions monitoring plan in accordance with paragraphs (p)(1) through (p)(4) of this section.

(1) Continuously monitor compliance with the HCl limit by operating a continuous emission monitor in accordance with



SECTION C. Site Level Requirements

Performance Specification 15 of appendix B to part 60 of this chapter. You must operate and maintain each CEMS according to the quality assurance requirements in Procedure 1 of 40 CFR of appendix F to part 60 of this chapter except that the Relative Accuracy Test Audit requirements of Procedure 1 must be replaced with the validation requirements and criteria of sections 11.1.1 and 12.0 of Performance Specification 15, or

(2) Install, operate, and maintain a CMS to monitor wet scrubber parameters as specified in paragraphs (m)(5) and (m)(7) of this section.

(m) Parameter monitoring requirements. If you have an operating limit that requires the use of a CMS, you must install, operate, and maintain each continuous parameter monitoring system (CPMS) according to the procedures in paragraphs (n)(1) through (4) of this section by the compliance date specified in §63.1351. You must also meet the applicable specific parameter monitoring requirements in paragraphs (m)(5) through (m)(11) that are applicable to you.

(1) The CMS must complete a minimum of one cycle of operation for each successive 15-minute period. You must have a minimum of four successive cycles of operation to have a valid hour of data.

(2) You must conduct all monitoring in continuous operation at all times that the unit is operating.

(3) Determine the 3-hour block average of all recorded readings.

(4) Record the results of each inspection, calibration, and validation check.

(5) Liquid flow rate monitoring requirements. If you have an operating limit that requires the use of a flow measurement device, you must meet the requirements in paragraphs (m)(5)(i) through (iv) of this section.

(i) Locate the flow sensor and other necessary equipment in a position that provides a representative flow.

(ii) Use a flow sensor with a measurement sensitivity of 2 percent of the flow rate.

(iii) Reduce swirling flow or abnormal velocity distributions due to upstream and downstream disturbances.

(iv) Conduct a flow sensor calibration check at least semiannually.

(6) Specific pressure monitoring requirements. If you have an operating limit that requires the use of a pressure measurement device, you must meet the requirements in paragraphs (m)(6)(i) through (vi) of this section.

(i) Locate the pressure sensor(s) in a position that provides a representative measurement of the pressure.

(ii) Minimize or eliminate pulsating pressure, vibration, and internal and external corrosion.

(iii) Use a gauge with a minimum tolerance of 1.27 centimeters of water or a transducer with a minimum tolerance of 1 percent of the pressure range.

(iv) Check pressure tap pluggage daily.

(v) Using a manometer, check gauge calibration quarterly and transducer calibration monthly.

(vi) Conduct calibration checks any time the sensor exceeds the manufacturer's specified maximum operating pressure range or install a new pressure sensor.

(7) Specific pH monitoring requirements. If you have an operating limit that requires the use of a pH measurement device, you must meet the requirements in paragraphs (m)(7)(i) through (iii) of this section.

(i) Locate the pH sensor in a position that provides a representative measurement of scrubber effluent pH.

(ii) Ensure the sample is properly mixed and representative of the fluid to be measured.



SECTION C. Site Level Requirements

(iii) Check the pH meter's calibration on at least two points every 8 hours of process operation.

(8) [Reserved]

(9) Mass flow rate (for sorbent injection) monitoring requirements. If you have an operating limit that requires the use of equipment to monitor sorbent injection rate (e.g., weigh belt, weigh hopper, or hopper flow measurement device), you must meet the requirements in paragraphs (m)(9)(i) through (iii) of this section.

(i) Locate the device in a position(s) that provides a representative measurement of the total sorbent injection rate.

(ii) Install and calibrate the device in accordance with manufacturer's procedures and specifications.

(iii) At least annually, calibrate the device in accordance with the manufacturer's procedures and specifications.

(10) Bag leak detection monitoring requirements. If you elect to use a fabric filter bag leak detection system to comply with the requirements of this subpart, you must install, calibrate, maintain, and continuously operate a bag leak detection system as specified in paragraphs (m)(10)(i) through (viii) of this section.

(i) You must install and operate a bag leak detection system for each exhaust stack of the fabric filter.

(ii) Each bag leak detection system must be installed, operated, calibrated, and maintained in a manner consistent with the manufacturer's written specifications and recommendations and in accordance with the guidance provided in EPA - 454/R - 98 - 015, September 1997.

(iii) The bag leak detection system must be certified by the manufacturer to be capable of detecting particulate matter emissions at concentrations of 10 or fewer milligrams per actual cubic meter.

(iv) The bag leak detection system sensor must provide output of relative or absolute particulate matter loadings.

(v) The bag leak detection system must be equipped with a device to continuously record the output signal from the sensor.

(vi) The bag leak detection system must be equipped with an alarm system that will alert an operator automatically when an increase in relative particulate matter emissions over a preset level is detected. The alarm must be located such that the alert is detected and recognized easily by an operator.

(vii) For positive pressure fabric filter systems that do not duct all compartments of cells to a common stack, a bag leak detection system must be installed in each baghouse compartment or cell.

(viii) Where multiple bag leak detectors are required, the system's instrumentation and alarm may be shared among detectors.

(11) For each BLDS, the owner or operator must initiate procedures to determine the cause of every alarm within 8 hours of the alarm. The owner or operator must alleviate the cause of the alarm within 24 hours of the alarm by taking whatever corrective action(s) are necessary. Corrective actions may include, but are not limited to the following:

(i) Inspecting the fabric filter for air leaks, torn or broken bags or filter media, or any other condition that may cause an increase in PM emissions;

(ii) Sealing off defective bags or filter media;

(iii) Replacing defective bags or filter media or otherwise repairing the control device;

(iv) Sealing off a defective fabric filter compartment;

(v) Cleaning the bag leak detection system probe or otherwise repairing the bag leak detection system; or

(vi) Shutting down the process producing the PM emissions.



SECTION C. Site Level Requirements

(n) Continuous emissions rate monitoring system. You must install, operate, calibrate, and maintain instruments, according to the requirements in paragraphs (n)(1) and (2) of this section, for continuously measuring and recording the pollutant per mass flow rate to the atmosphere from sources subject to an emissions limitation that has a pounds per ton of clinker unit.

(1) You must install each sensor of the flow rate monitoring system in a location that provides representative measurement of the exhaust gas flow rate at the sampling location of the mercury or PM CEMS, taking into account the manufacturer's recommendations. The flow rate sensor is that portion of the system that senses the volumetric flow rate and generates an output proportional to that flow rate.

(2) The flow rate monitoring system must be designed to measure the exhaust flow rate over a range that extends from a value of at least 20 percent less than the lowest expected exhaust flow rate to a value of at least 20 percent greater than the highest expected exhaust flow rate.

(3) The flow rate monitoring system must have a minimum accuracy of 5 percent of the flow rate or greater.

(4) The flow rate monitoring system must be equipped with a data acquisition and recording system that is capable of recording values over the entire range specified in paragraph (n)(1) of this section.

(5) The signal conditioner, wiring, power supply, and data acquisition and recording system for the flow rate monitoring system must be compatible with the output signal of the flow rate sensors used in the monitoring system.

(6) The flow rate monitoring system must be designed to complete a minimum of one cycle of operation for each successive 15-minute period.

(7) The flow rate sensor must have provisions to determine the daily zero and upscale calibration drift (CD) (see sections 3.1 and 8.3 of Performance Specification 2 in appendix B to Part 60 of this chapter for a discussion of CD).

(i) Conduct the CD tests at two reference signal levels, zero (e.g., 0 to 20 percent of span) and upscale (e.g., 50 to 70 percent of span).

(ii) The absolute value of the difference between the flow monitor response and the reference signal must be equal to or less than 3 percent of the flow monitor span.

(8) You must perform an initial relative accuracy test of the flow rate monitoring system according to Section 8.2 of Performance Specification 6 of appendix B to Part 60 of the chapter with the exceptions in paragraphs (n)(8)(i) and (n)(8)(ii) of this section.

(i) The relative accuracy test is to evaluate the flow rate monitoring system alone rather than a continuous emission rate monitoring system.

(ii) The relative accuracy of the flow rate monitoring system shall be no greater than 10 percent of the mean value of the reference method data.

(9) You must verify the accuracy of the flow rate monitoring system at least once per year by repeating the relative accuracy test specified in paragraph (n)(8).

(10) You must operate the flow rate monitoring system and record data during all periods of operation of the affected facility including periods of startup, shutdown, and malfunction, except for periods of monitoring system malfunctions, repairs associated with monitoring system malfunctions, and required monitoring system quality assurance or quality control activities (including, as applicable, calibration checks and required zero and span adjustments).

(o) Alternate monitoring requirements approval. You may submit an application to the Administrator for approval of alternate monitoring requirements to demonstrate compliance with the emission standards of this subpart, except for emission standards for THC, subject to the provisions of paragraphs (n)(1) through (n)(6) of this section.

(1) The Administrator will not approve averaging periods other than those specified in this section, unless you document, using data or information, that the longer averaging period will ensure that emissions do not exceed levels achieved during



SECTION C. Site Level Requirements

the performance test over any increment of time equivalent to the time required to conduct three runs of the performance test.

(2) If the application to use an alternate monitoring requirement is approved, you must continue to use the original monitoring requirement until approval is received to use another monitoring requirement.

(3) You must submit the application for approval of alternate monitoring requirements no later than the notification of performance test. The application must contain the information specified in paragraphs (m)(3)(i) through (iii) of this section:

- (i) Data or information justifying the request, such as the technical or economic infeasibility, or the impracticality of using the required approach;
- (ii) A description of the proposed alternative monitoring requirement, including the operating parameter to be monitored, the monitoring approach and technique, the averaging period for the limit, and how the limit is to be calculated; and
- (iii) Data or information documenting that the alternative monitoring requirement would provide equivalent or better assurance of compliance with the relevant emission standard.

(4) The Administrator will notify you of the approval or denial of the application within 90 calendar days after receipt of the original request, or within 60 calendar days of the receipt of any supplementary information, whichever is later. The Administrator will not approve an alternate monitoring application unless it would provide equivalent or better assurance of compliance with the relevant emission standard. Before disapproving any alternate monitoring application, the Administrator will provide:

- (i) Notice of the information and findings upon which the intended disapproval is based; and
 - (ii) Notice of opportunity for you to present additional supporting information before final action is taken on the application. This notice will specify how much additional time is allowed for you to provide additional supporting information.
- (5) You are responsible for submitting any supporting information in a timely manner to enable the Administrator to consider the application prior to the performance test. Neither submittal of an application, nor the Administrator's failure to approve or disapprove the application relieves you of the responsibility to comply with any provision of this subpart.
- (6) The Administrator may decide at any time, on a case-by-case basis that additional or alternative operating limits, or alternative approaches to establishing operating limits, are necessary to demonstrate compliance with the emission standards of this subpart.

(p) Development and submittal (upon request) of monitoring plans. If you demonstrate compliance with any applicable emission limit through performance stack testing or other emissions monitoring, you must develop a site-specific monitoring plan according to the requirements in paragraphs (p)(1) through (4) of this section. This requirement also applies to you if you petition the EPA Administrator for alternative monitoring parameters under paragraph (n) of this section and §63.8(f). If you use a BLDS, you must also meet the requirements specified in paragraph (o)(5) of this section.

(1) For each continuous monitoring system (CMS) required in this section, you must develop, and submit to the permitting authority for approval upon request, a site-specific monitoring plan that addresses paragraphs (o)(1)(i) through (iii) of this section. You must submit this site-specific monitoring plan, if requested, at least 60 days before your initial performance evaluation of your CMS.

- (i) Installation of the CMS sampling probe or other interface at a measurement location relative to each affected process unit such that the measurement is representative of control of the exhaust emissions (e.g., on or downstream of the last control device);
- (ii) Performance and equipment specifications for the sample interface, the pollutant concentration or parametric signal analyzer, and the data collection and reduction systems; and
- (iii) Performance evaluation procedures and acceptance criteria (e.g., calibrations).

(2) In your site-specific monitoring plan, you must also address paragraphs (o)(2)(i) through (iii) of this section.



SECTION C. Site Level Requirements

- (i) Ongoing operation and maintenance procedures in accordance with the general requirements of §63.8(c)(1), (c)(3), and (c)(4)(ii);
- (ii) Ongoing data quality assurance procedures in accordance with the general requirements of §63.8(d); and
- (iii) Ongoing recordkeeping and reporting procedures in accordance with the general requirements of §63.10(c), (e)(1), and (e)(2)(i).
- (3) You must conduct a performance evaluation of each CMS in accordance with your site-specific monitoring plan.
- (4) You must operate and maintain the CMS in continuous operation according to the site-specific monitoring plan.
- (5) BLDS monitoring plan. Each monitoring plan must describe the items in paragraphs (o)(5)(i) through (v) of this section. At a minimum, you must retain records related to the site-specific monitoring plan and information discussed in paragraphs (m)(1) through (4), (m)(10) and (m)(11) of this section for a period of 5 years, with at least the first 2 years on-site;
 - (i) Installation of the BLDS;
 - (ii) Initial and periodic adjustment of the BLDS, including how the alarm set-point will be established;
 - (iii) Operation of the BLDS, including quality assurance procedures;
 - (iv) How the BLDS will be maintained, including a routine maintenance schedule and spare parts inventory list;
 - (v) How the BLDS output will be recorded and stored.

[75 FR 55059, Sept. 9, 2010, as amended at 76 FR 2836, Jan. 18, 2011]

026 [40 CFR Part 63 NESHAPS for Source Categories §40 CFR 63.1351]

[Subpart LLL -- National Emission Standards for Hazardous Air Pollutants From the Portland Cement Manufacturing Industry](#)
[Compliance dates.](#)

This condition only applies to sources regulated by 40 CFR Part 63, Subpart LLL, as indicated in Sections D or E of this permit.

(a) The compliance date for any affected existing source subject to any rule requirements that were in effect before December 20, 2006, is:

- (1) June 14, 2002, for sources that commenced construction before or on March 24, 1998, or
- (2) June 14, 1999 or startup for sources that commenced construction after March 24, 1998.

(b) The compliance date for any affected existing source subject to any rule requirements that became effective on December 20, 2006, is:

- (1) December 21, 2009, for sources that commenced construction after December 2, 2005 and before or on December 20, 2006, or
- (2) Startup for sources that commenced construction after December 20, 2006.

(c) The compliance date for existing sources for all the requirements that became effective on November 8, 2010 will be September 9, 2013.

(d) The compliance date for new sources is November 9, 2010 or startup, whichever is later.

[76 FR 2836, Jan. 18, 2011]



SECTION C. Site Level Requirements

027 [40 CFR Part 63 NESHAPS for Source Categories §40 CFR 63.1353]

Subpart LLL -- National Emission Standards for Hazardous Air Pollutants From the Portland Cement Manufacturing Industry

Notification requirements.

This condition only applies to sources regulated by 40 CFR Part 63, Subpart LLL, as indicated in Sections D or E of this permit.

(a) The notification provisions of 40 CFR Part 63, Subpart A that apply and those that do not apply to owners and operators of affected sources subject to this subpart are listed in Table 1 of this subpart. If any State requires a notice that contains all of the information required in a notification listed in this section, the owner or operator may send the Administrator a copy of the notice sent to the State to satisfy the requirements of this section for that notification.

(b) Each owner or operator subject to the requirements of this subpart shall comply with the notification requirements in [40 CFR] Section 63.9 as follows:

(1) Initial notifications as required by Section 63.9(b) through (d). For the purposes of this Subpart, a Title V or 40 CFR Part 70 permit application may be used in lieu of the initial notification required under Section 63.9(b), provided the same information is contained in the permit application as required by Section 63.9(b), and the State to which the permit application has been submitted has an approved operating permit program under Part 70 of this chapter and has received delegation of authority from the EPA. Permit applications shall be submitted by the same due dates as those specified for the initial notification.

(2) Notification of performance tests, as required by Sections 63.7 and 63.9(e).

(3) Notification of opacity and visible emission observations required by Section 63.1349 in accordance with Sections 63.6(h)(5) and 63.9(f).

(4) Notification, as required by Section 63.9(g), of the date that the continuous emission monitor performance evaluation required by Section 63.8(e) is scheduled to begin.

(5) Notification of compliance status, as required by Section 63.9(h).

028 [40 CFR Part 63 NESHAPS for Source Categories §40 CFR 63.1354]

Subpart LLL -- National Emission Standards for Hazardous Air Pollutants From the Portland Cement Manufacturing Industry

Reporting requirements.

This condition only applies to sources regulated by 40 CFR Part 63, Subpart LLL, as indicated in Sections D or E of this permit.

(a) The reporting provisions of [40 CFR Part 63] Subpart A of this part that apply and those that do not apply to owners or operators of affected sources subject to this subpart are listed in Table 1 of this subpart. If any State requires a report that contains all of the information required in a report listed in this section, the owner or operator may send the Administrator a copy of the report sent to the State to satisfy the requirements of this section for that report.

(b) The owner or operator of an affected source shall comply with the reporting requirements specified in [40 CFR] Section 63.10 of the general provisions of this Part 63, Subpart A as follows:

(1) As required by Section 63.10(d)(2), the owner or operator shall report the results of performance tests as part of the notification of compliance status.

(2) As required by Section 63.10(d)(3), the owner or operator of an affected source shall report the opacity results from tests required by Section 63.1349.

(3) As required by Section 63.10(d)(4), the owner or operator of an affected source who is required to submit progress reports as a condition of receiving an extension of compliance under Section 63.6(i) shall submit such reports by the dates specified in the written extension of compliance.



SECTION C. Site Level Requirements

(4) As required by Section 63.10(d)(5), if actions taken by an owner or operator during a startup, shutdown, or malfunction of an affected source (including actions taken to correct a malfunction) are consistent with the procedures specified in the source's startup, shutdown, and malfunction plan specified in Section 63.6(e)(3), the owner or operator shall state such information in a semiannual report. Reports shall only be required if a startup, shutdown, or malfunction occurred during the reporting period. The startup, shutdown, and malfunction report may be submitted simultaneously with the excess emissions and continuous monitoring system performance reports; and

(5) Any time an action taken by an owner or operator during a startup, shutdown, or malfunction (including actions taken to correct a malfunction) is not consistent with the procedures in the startup, shutdown, and malfunction plan, the owner or operator shall make an immediate report of the actions taken for that event within two (2) working days, by telephone call or facsimile (FAX) transmission. The immediate report shall be followed by a letter, certified by the owner or operator or other responsible official, explaining the circumstances of the event, the reasons for not following the startup, shutdown, and malfunction plan, and whether any excess emissions and/or parameter monitoring exceedances are believed to have occurred.

(6) As required by Section 63.10(e)(2), the owner or operator shall submit a written report of the results of the performance evaluation for the continuous monitoring system required by Section 63.8(e). The owner or operator shall submit the report simultaneously with the results of the performance test.

(7) As required by Section 63.10(e)(2), the owner or operator of an affected source using a continuous opacity monitoring system to determine opacity compliance during any performance test required under Section 63.7 and described in Section 63.6(d)(6) shall report the results of the continuous opacity monitoring system performance evaluation conducted under Section 63.8(e).

(8) As required by Section 63.10(e)(3), the owner or operator of an affected source equipped with a continuous emission monitor shall submit an excess emissions and continuous monitoring system performance report for any event when the continuous monitoring system data indicate the source is not in compliance with the applicable emission limitation or operating parameter limit.

(9) The owner or operator shall submit a summary report semiannually which contains the information specified in Section 63.10(e)(3)(vi). In addition, the summary report shall include:

- (i) All exceedances of maximum control device inlet gas temperature limits specified in Section 63.1344(a) and (b);
- (ii) All failures to calibrate thermocouples and other temperature sensors as required under Section 63.1350(f)(7) of this subpart; and
- (iii) All failures to maintain the activated carbon injection rate, and the activated carbon injection carrier gas flow rate or pressure drop, as applicable, as required under Section 63.1344(c).
- (iv) The results of any combustion system component inspections conducted within the reporting period as required under Section 63.1350(i).
- (v) All failures to comply with any provision of the operation and maintenance plan developed in accordance with Section 63.1350(a).
- (vi) Monthly rolling average mercury, THC, PM, and HCl (if applicable) emissions levels in the units of the applicable emissions limit for each kiln, clinker cooler, and raw material dryer.

(10) If the total continuous monitoring system downtime for any CEM or any continuous monitoring system (CMS) for the reporting period is ten percent or greater of the total operating time for the reporting period, the owner or operator shall submit an excess emissions and continuous monitoring system performance report along with the summary report.

(c) The semiannual report required by paragraph (b)(9) of this section must include the number, duration, and a brief description for each type of malfunction which occurred during the reporting period and which caused or may have caused any applicable emission limitation to be exceeded. The report must also include a description of actions taken by an owner or operator during a malfunction of an affected source to minimize emissions in accordance with §63.1348(d), including actions



SECTION C. Site Level Requirements

taken to correct a malfunction.

[64 FR 31925, June 14, 1999, as amended at 75 FR 55063, Sept. 9, 2010]

029 [40 CFR Part 63 NESHAPS for Source Categories §40 CFR 63.1355]

Subpart LLL -- National Emission Standards for Hazardous Air Pollutants From the Portland Cement Manufacturing Industry

Recordkeeping requirements.

This condition only applies to sources regulated by 40 CFR Part 63, Subpart LLL, as indicated in Sections D or E of this permit.

(a) The owner or operator shall maintain files of all information (including all reports and notifications) required by this section recorded in a form suitable and readily available for inspection and review as required by [40 CFR] Section 63.10(b)(1). The files shall be retained for at least five (5) years following the date of each occurrence, measurement, maintenance, corrective action, report, or record. At a minimum, the most recent two (2) years of data shall be retained on site. The remaining three (3) years of data may be retained off site. The files may be maintained on microfilm, on a computer, on floppy disks, on magnetic tape, or on microfiche.

(b) The owner or operator shall maintain records for each affected source as required by Section 63.10(b)(2) and (b)(3) of this part; and

(1) All documentation supporting initial notifications and notifications of compliance status under Section 63.9;

(2) All records of applicability determination, including supporting analyses; and

(3) If the owner or operator has been granted a waiver under Section 63.8(f)(6), any information demonstrating whether a source is meeting the requirements for a waiver of recordkeeping or reporting requirements.

(c) In addition to the recordkeeping requirements in Paragraph (b) of this section, the owner or operator of an affected source equipped with a continuous monitoring system shall maintain all records required by Section 63.10(c).

(d) You must keep annual records of the amount of CKD which is removed from the kiln system and either disposed of as solid waste or otherwise recycled for a beneficial use outside of the kiln system.

(e) You must keep records of the daily clinker production rates and kiln feed rates.

(f) You must keep records of the occurrence and duration of each startup or shutdown.

(g)(1) You must keep records of the occurrence and duration of each malfunction of operation (i.e., process equipment) or the air pollution control and monitoring equipment.

(2) You must keep records of actions taken during periods of malfunction to minimize emissions in accordance with §63.1348(d) including corrective actions to restore malfunctioning process and air pollution control and monitoring equipment to its normal or usual manner of operation.

[64 FR 31925, June 14, 1999, as amended at 71 FR 76552, Dec. 20, 2006; 75 FR 55064, Sept. 9, 2010]

030 [40 CFR Part 63 NESHAPS for Source Categories §40 CFR 63.4]

Subpart A--General Provisions

Prohibited activities and circumvention.

[From 40 CFR 63.4(b) and (c)]

(b) Circumvention. No owner or operator subject to the provisions of this part shall build, erect, install, or use any article, machine, equipment, or process to conceal an emission that would otherwise constitute noncompliance with a relevant standard. Such concealment includes, but is not limited to--

(1) The use of diluents to achieve compliance with a relevant standard based on the concentration of a pollutant in the effluent discharged to the atmosphere;



SECTION C. Site Level Requirements

(2) The use of gaseous diluents to achieve compliance with a relevant standard for visible emissions; and

(c) Fragmentation. Fragmentation after November 15, 1990 which divides ownership of an operation, within the same facility among various owners where there is no real change in control, will not affect applicability. The owner and operator must not use fragmentation or phasing of reconstruction activities (i.e., intentionally dividing reconstruction into multiple parts for purposes of avoiding new source requirements) to avoid becoming subject to new source requirements.

031 [40 CFR Part 63 NESHAPS for Source Categories §40 CFR 63.6]

[Subpart A--General Provisions](#)

[Compliance with standards and maintenance requirements.](#)

[From 40 CFR 63.6(f)]

(f)(1) NA

(2) Methods for determining compliance. (i) The Administrator will determine compliance with nonopacity emission standards in this part based on the results of performance tests conducted according to the procedures in §63.7, unless otherwise specified in an applicable subpart of this part.

(ii) The Administrator will determine compliance with nonopacity emission standards in this part by evaluation of an owner or operator's conformance with operation and maintenance requirements, including the evaluation of monitoring data, as specified in §63.6(e) and applicable subparts of this part.

(iii) If an affected source conducts performance testing at startup to obtain an operating permit in the State in which the source is located, the results of such testing may be used to demonstrate compliance with a relevant standard if --

(A) The performance test was conducted within a reasonable amount of time before an initial performance test is required to be conducted under the relevant standard;

(B) The performance test was conducted under representative operating conditions for the source;

(C) The performance test was conducted and the resulting data were reduced using EPA-approved test methods and procedures, as specified in §63.7(e) of this subpart; and

(D) The performance test was appropriately quality-assured, as specified in §63.7(c).

(iv) The Administrator will determine compliance with design, equipment, work practice, or operational emission standards in this part by review of records, inspection of the source, and other procedures specified in applicable subparts of this part.

(v) The Administrator will determine compliance with design, equipment, work practice, or operational emission standards in this part by evaluation of an owner or operator's conformance with operation and maintenance requirements, as specified in paragraph (e) of this section and applicable subparts of this part.

(3) Finding of compliance. The Administrator will make a finding concerning an affected source's compliance with a non-opacity emission standard, as specified in paragraphs (f)(1) and (2) of this section, upon obtaining all the compliance information required by the relevant standard (including the written reports of performance test results, monitoring results, and other information, if applicable), and information available to the Administrator pursuant to paragraph (e)(1)(i) of this section.

[From 40 CFR 63.6(h)]

Compliance with opacity and visible emission standards--

(1) NA.

(2) The Administrator will determine compliance with opacity and visible emission standards in this part in accordance with the requirements contained in 40 CFR 63.6(h)(2).



SECTION C. Site Level Requirements

(3) [Reserved]

(4) Notification of opacity or visible emission observations. The owner or operator of an affected source shall notify the Administrator in writing of the anticipated date for conducting opacity or visible emission observations in accordance with 63.9(f), if such observations are required for the source by a relevant standard.

(5) Conduct of opacity or visible emission observations. When a relevant standard under this part includes an opacity or visible emission standard, the owner or operator of an affected source shall comply with the requirements contained in 40 CFR 63.6(h)(5)(i).

(6) Availability of records. The owner or operator of an affected source shall make available, upon request by the Administrator, such records that the Administrator deems necessary to determine the conditions under which the visual observations were made and shall provide evidence indicating proof of current visible observer emission certification.

(7) Use of a continuous opacity monitoring system. The owner or operator of an affected source required to use a continuous opacity monitoring system, shall comply with the requirements contained in 40 CFR 63.6(h)(7)(i)-(v).

(8) Finding of compliance. The Administrator will make a finding concerning an affected source's compliance with an opacity or visible emission standard upon obtaining all the compliance information required by the relevant standard (including the written reports of the results of the performance tests required by 63.7, the results of Test Method 9 or another required opacity or visible emission test method, the observer certification required by paragraph (h)(6) of this section, and the continuous opacity monitoring system results, whichever is/are applicable) and any information available to the Administrator needed to determine whether proper operation and maintenance practices are being used.

VIII. COMPLIANCE CERTIFICATION.

The permittee shall submit within thirty days of 12/31/2011 a certificate of compliance with all permit terms and conditions set forth in this Title V permit as required under condition #24 of section B of this permit, and annually thereafter.

IX. COMPLIANCE SCHEDULE.

No compliance milestones exist.

*** Permit Shield In Effect **

**SECTION D. Source Level Requirements**

Source ID: 101

Source Name: UNLOAD INTO #4 BELT TRUCK HOPPER

Source Capacity/Throughput:	186.000 Tons/HR	RAW MATERIALS
	1.000 Th Tons/HR	STONE/SHALE

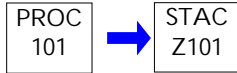
**I. RESTRICTIONS.**

No additional requirements exist except as provided in other sections of this permit including Section B (Title V General Requirements).

II. TESTING REQUIREMENTS.

No additional testing requirements exist except as provided in other sections of this permit including Section B (Title V General Requirements).

III. MONITORING REQUIREMENTS.

No additional monitoring requirements exist except as provided in other sections of this permit including Section B (Title V General Requirements).

IV. RECORDKEEPING REQUIREMENTS.

No additional record keeping requirements exist except as provided in other sections of this permit including Section B (Title V General Requirements).

V. REPORTING REQUIREMENTS.

No additional reporting requirements exist except as provided in other sections of this permit including Section B (Title V General Requirements).

VI. WORK PRACTICE REQUIREMENTS.

No additional work practice requirements exist except as provided in other sections of this permit including Section B (Title V General Requirements).

VII. ADDITIONAL REQUIREMENTS.

No additional requirements exist except as provided in other sections of this permit including Section B (Title V General Requirements).

*** Permit Shield in Effect. ***

**SECTION D. Source Level Requirements**

Source ID: 103

Source Name: #4 BELT TO TURN HEAD TRANSFER

Source Capacity/Throughput: 186.000 Tons/HR RAW MATERIALS

Conditions for this source occur in the following groups: 5 - OTHER NESHAP AFFECTED SOURCES

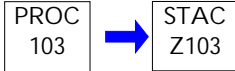
**I. RESTRICTIONS.**

No additional requirements exist except as provided in other sections of this permit including Section B (Title V General Requirements) and/or Section E (Source Group Restrictions).

II. TESTING REQUIREMENTS.

No additional testing requirements exist except as provided in other sections of this permit including Section B (Title V General Requirements) and/or Section E (Source Group Restrictions).

III. MONITORING REQUIREMENTS.

No additional monitoring requirements exist except as provided in other sections of this permit including Section B (Title V General Requirements) and/or Section E (Source Group Restrictions).

IV. RECORDKEEPING REQUIREMENTS.

No additional record keeping requirements exist except as provided in other sections of this permit including Section B (Title V General Requirements) and/or Section E (Source Group Restrictions).

V. REPORTING REQUIREMENTS.

No additional reporting requirements exist except as provided in other sections of this permit including Section B (Title V General Requirements) and/or Section E (Source Group Restrictions).

VI. WORK PRACTICE REQUIREMENTS.

No additional work practice requirements exist except as provided in other sections of this permit including Section B (Title V General Requirements) and/or Section E (Source Group Restrictions).

VII. ADDITIONAL REQUIREMENTS.

No additional requirements exist except as provided in other sections of this permit including Section B (Title V General Requirements) and/or Section E (Source Group Restrictions).

*** Permit Shield in Effect. ***

**SECTION D. Source Level Requirements**

Source ID: 104

Source Name: UNLOAD INTO LIMESTONE PILE

Source Capacity/Throughput:

13.000 Tons/HR

LIMESTONE

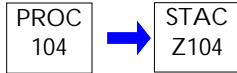
**I. RESTRICTIONS.**

No additional requirements exist except as provided in other sections of this permit including Section B (Title V General Requirements).

II. TESTING REQUIREMENTS.

No additional testing requirements exist except as provided in other sections of this permit including Section B (Title V General Requirements).

III. MONITORING REQUIREMENTS.

No additional monitoring requirements exist except as provided in other sections of this permit including Section B (Title V General Requirements).

IV. RECORDKEEPING REQUIREMENTS.

No additional record keeping requirements exist except as provided in other sections of this permit including Section B (Title V General Requirements).

V. REPORTING REQUIREMENTS.

No additional reporting requirements exist except as provided in other sections of this permit including Section B (Title V General Requirements).

VI. WORK PRACTICE REQUIREMENTS.

No additional work practice requirements exist except as provided in other sections of this permit including Section B (Title V General Requirements).

VII. ADDITIONAL REQUIREMENTS.

No additional requirements exist except as provided in other sections of this permit including Section B (Title V General Requirements).

*** Permit Shield in Effect. ***

SECTION D. Source Level Requirements

Source ID: 105

Source Name: REMOVE FROM LIMESTONE PILE

Source Capacity/Throughput:

13.000 Tons/HR

LIMESTONE

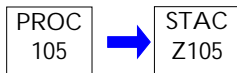
**I. RESTRICTIONS.**

No additional requirements exist except as provided in other sections of this permit including Section B (Title V General Requirements).

II. TESTING REQUIREMENTS.

No additional testing requirements exist except as provided in other sections of this permit including Section B (Title V General Requirements).

III. MONITORING REQUIREMENTS.

No additional monitoring requirements exist except as provided in other sections of this permit including Section B (Title V General Requirements).

IV. RECORDKEEPING REQUIREMENTS.

No additional record keeping requirements exist except as provided in other sections of this permit including Section B (Title V General Requirements).

V. REPORTING REQUIREMENTS.

No additional reporting requirements exist except as provided in other sections of this permit including Section B (Title V General Requirements).

VI. WORK PRACTICE REQUIREMENTS.

No additional work practice requirements exist except as provided in other sections of this permit including Section B (Title V General Requirements).

VII. ADDITIONAL REQUIREMENTS.

No additional requirements exist except as provided in other sections of this permit including Section B (Title V General Requirements).

*** Permit Shield in Effect. ***

**SECTION D. Source Level Requirements**

Source ID: 106

Source Name: UNLOAD INTO COAL PILE

Source Capacity/Throughput: 15.000 Tons/HR COAL

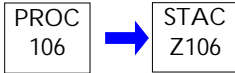
**I. RESTRICTIONS.**

No additional requirements exist except as provided in other sections of this permit including Section B (Title V General Requirements).

II. TESTING REQUIREMENTS.

No additional testing requirements exist except as provided in other sections of this permit including Section B (Title V General Requirements).

III. MONITORING REQUIREMENTS.

No additional monitoring requirements exist except as provided in other sections of this permit including Section B (Title V General Requirements).

IV. RECORDKEEPING REQUIREMENTS.

No additional record keeping requirements exist except as provided in other sections of this permit including Section B (Title V General Requirements).

V. REPORTING REQUIREMENTS.

No additional reporting requirements exist except as provided in other sections of this permit including Section B (Title V General Requirements).

VI. WORK PRACTICE REQUIREMENTS.

No additional work practice requirements exist except as provided in other sections of this permit including Section B (Title V General Requirements).

VII. ADDITIONAL REQUIREMENTS.

No additional requirements exist except as provided in other sections of this permit including Section B (Title V General Requirements).

*** Permit Shield in Effect. ***

**SECTION D. Source Level Requirements**

Source ID: 107

Source Name: REMOVE FROM COAL PILE

Source Capacity/Throughput: 10.500 Tons/HR COAL

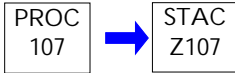
**I. RESTRICTIONS.**

No additional requirements exist except as provided in other sections of this permit including Section B (Title V General Requirements).

II. TESTING REQUIREMENTS.

No additional testing requirements exist except as provided in other sections of this permit including Section B (Title V General Requirements).

III. MONITORING REQUIREMENTS.

No additional monitoring requirements exist except as provided in other sections of this permit including Section B (Title V General Requirements).

IV. RECORDKEEPING REQUIREMENTS.

No additional record keeping requirements exist except as provided in other sections of this permit including Section B (Title V General Requirements).

V. REPORTING REQUIREMENTS.

No additional reporting requirements exist except as provided in other sections of this permit including Section B (Title V General Requirements).

VI. WORK PRACTICE REQUIREMENTS.

No additional work practice requirements exist except as provided in other sections of this permit including Section B (Title V General Requirements).

VII. ADDITIONAL REQUIREMENTS.

No additional requirements exist except as provided in other sections of this permit including Section B (Title V General Requirements).

*** Permit Shield in Effect. ***

**SECTION D. Source Level Requirements**

Source ID: 108

Source Name: UNLOAD INTO GYPSUM PILE

Source Capacity/Throughput:

5.000 Tons/HR

GYPSUM

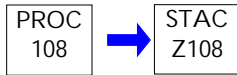
**I. RESTRICTIONS.**

No additional requirements exist except as provided in other sections of this permit including Section B (Title V General Requirements).

II. TESTING REQUIREMENTS.

No additional testing requirements exist except as provided in other sections of this permit including Section B (Title V General Requirements).

III. MONITORING REQUIREMENTS.

No additional monitoring requirements exist except as provided in other sections of this permit including Section B (Title V General Requirements).

IV. RECORDKEEPING REQUIREMENTS.

No additional record keeping requirements exist except as provided in other sections of this permit including Section B (Title V General Requirements).

V. REPORTING REQUIREMENTS.

No additional reporting requirements exist except as provided in other sections of this permit including Section B (Title V General Requirements).

VI. WORK PRACTICE REQUIREMENTS.

No additional work practice requirements exist except as provided in other sections of this permit including Section B (Title V General Requirements).

VII. ADDITIONAL REQUIREMENTS.

No additional requirements exist except as provided in other sections of this permit including Section B (Title V General Requirements).

*** Permit Shield in Effect. ***

**SECTION D. Source Level Requirements**

Source ID: 109

Source Name: REMOVE FROM GYPSUM PILE

Source Capacity/Throughput:

5.000 Tons/HR

GYPSUM

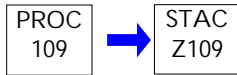
**I. RESTRICTIONS.**

No additional requirements exist except as provided in other sections of this permit including Section B (Title V General Requirements).

II. TESTING REQUIREMENTS.

No additional testing requirements exist except as provided in other sections of this permit including Section B (Title V General Requirements).

III. MONITORING REQUIREMENTS.

No additional monitoring requirements exist except as provided in other sections of this permit including Section B (Title V General Requirements).

IV. RECORDKEEPING REQUIREMENTS.

No additional record keeping requirements exist except as provided in other sections of this permit including Section B (Title V General Requirements).

V. REPORTING REQUIREMENTS.

No additional reporting requirements exist except as provided in other sections of this permit including Section B (Title V General Requirements).

VI. WORK PRACTICE REQUIREMENTS.

No additional work practice requirements exist except as provided in other sections of this permit including Section B (Title V General Requirements).

VII. ADDITIONAL REQUIREMENTS.

No additional requirements exist except as provided in other sections of this permit including Section B (Title V General Requirements).

*** Permit Shield in Effect. ***

**SECTION D. Source Level Requirements**

Source ID: 110

Source Name: UNLOAD INTO #3 BELT TRUCK HOPPER

Source Capacity/Throughput: 143.000 Tons/HR LIMESTONE/SHALE

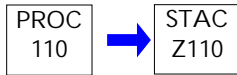
**I. RESTRICTIONS.**

No additional requirements exist except as provided in other sections of this permit including Section B (Title V General Requirements).

II. TESTING REQUIREMENTS.

No additional testing requirements exist except as provided in other sections of this permit including Section B (Title V General Requirements).

III. MONITORING REQUIREMENTS.

No additional monitoring requirements exist except as provided in other sections of this permit including Section B (Title V General Requirements).

IV. RECORDKEEPING REQUIREMENTS.

No additional record keeping requirements exist except as provided in other sections of this permit including Section B (Title V General Requirements).

V. REPORTING REQUIREMENTS.

No additional reporting requirements exist except as provided in other sections of this permit including Section B (Title V General Requirements).

VI. WORK PRACTICE REQUIREMENTS.

No additional work practice requirements exist except as provided in other sections of this permit including Section B (Title V General Requirements).

VII. ADDITIONAL REQUIREMENTS.

No additional requirements exist except as provided in other sections of this permit including Section B (Title V General Requirements).

*** Permit Shield in Effect. ***

SECTION D. Source Level Requirements

Source ID: 111

Source Name: #3 BELT TO TURN HEAD TRANSFER

Source Capacity/Throughput: 143.000 Tons/HR LIMESTONE/SHALE

Conditions for this source occur in the following groups: 5 - OTHER NESHAP AFFECTED SOURCES

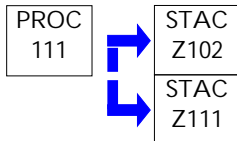
**I. RESTRICTIONS.**

No additional requirements exist except as provided in other sections of this permit including Section B (Title V General Requirements) and/or Section E (Source Group Restrictions).

II. TESTING REQUIREMENTS.

No additional testing requirements exist except as provided in other sections of this permit including Section B (Title V General Requirements) and/or Section E (Source Group Restrictions).

III. MONITORING REQUIREMENTS.

No additional monitoring requirements exist except as provided in other sections of this permit including Section B (Title V General Requirements) and/or Section E (Source Group Restrictions).

IV. RECORDKEEPING REQUIREMENTS.

No additional record keeping requirements exist except as provided in other sections of this permit including Section B (Title V General Requirements) and/or Section E (Source Group Restrictions).

V. REPORTING REQUIREMENTS.

No additional reporting requirements exist except as provided in other sections of this permit including Section B (Title V General Requirements) and/or Section E (Source Group Restrictions).

VI. WORK PRACTICE REQUIREMENTS.

No additional work practice requirements exist except as provided in other sections of this permit including Section B (Title V General Requirements) and/or Section E (Source Group Restrictions).

VII. ADDITIONAL REQUIREMENTS.

No additional requirements exist except as provided in other sections of this permit including Section B (Title V General Requirements) and/or Section E (Source Group Restrictions).

*** Permit Shield in Effect. ***

SECTION D. Source Level Requirements

Source ID: 112

Source Name: #7 BELT TO #4 SILO TRANSFER

Source Capacity/Throughput:

50.000 Tons/HR

CLINKER

Conditions for this source occur in the following groups: 5 - OTHER NESHAP AFFECTED SOURCES

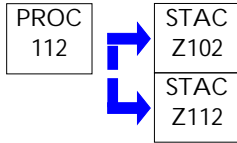
**I. RESTRICTIONS.**

No additional requirements exist except as provided in other sections of this permit including Section B (Title V General Requirements) and/or Section E (Source Group Restrictions).

II. TESTING REQUIREMENTS.

No additional testing requirements exist except as provided in other sections of this permit including Section B (Title V General Requirements) and/or Section E (Source Group Restrictions).

III. MONITORING REQUIREMENTS.

No additional monitoring requirements exist except as provided in other sections of this permit including Section B (Title V General Requirements) and/or Section E (Source Group Restrictions).

IV. RECORDKEEPING REQUIREMENTS.

No additional record keeping requirements exist except as provided in other sections of this permit including Section B (Title V General Requirements) and/or Section E (Source Group Restrictions).

V. REPORTING REQUIREMENTS.

No additional reporting requirements exist except as provided in other sections of this permit including Section B (Title V General Requirements) and/or Section E (Source Group Restrictions).

VI. WORK PRACTICE REQUIREMENTS.

No additional work practice requirements exist except as provided in other sections of this permit including Section B (Title V General Requirements) and/or Section E (Source Group Restrictions).

VII. ADDITIONAL REQUIREMENTS.

No additional requirements exist except as provided in other sections of this permit including Section B (Title V General Requirements) and/or Section E (Source Group Restrictions).

*** Permit Shield in Effect. ***

SECTION D. Source Level Requirements

Source ID: 113

Source Name: GYPSUM BELT TO #15 SILO TRANSFER

Source Capacity/Throughput: 5.000 Tons/HR GYPSUM

Conditions for this source occur in the following groups: 5 - OTHER NESHAP AFFECTED SOURCES

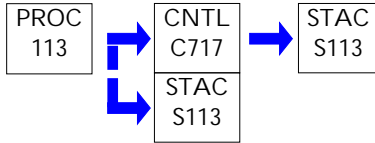
**I. RESTRICTIONS.**

No additional requirements exist except as provided in other sections of this permit including Section B (Title V General Requirements) and/or Section E (Source Group Restrictions).

II. TESTING REQUIREMENTS.

No additional testing requirements exist except as provided in other sections of this permit including Section B (Title V General Requirements) and/or Section E (Source Group Restrictions).

III. MONITORING REQUIREMENTS.

No additional monitoring requirements exist except as provided in other sections of this permit including Section B (Title V General Requirements) and/or Section E (Source Group Restrictions).

IV. RECORDKEEPING REQUIREMENTS.

No additional record keeping requirements exist except as provided in other sections of this permit including Section B (Title V General Requirements) and/or Section E (Source Group Restrictions).

V. REPORTING REQUIREMENTS.

No additional reporting requirements exist except as provided in other sections of this permit including Section B (Title V General Requirements) and/or Section E (Source Group Restrictions).

VI. WORK PRACTICE REQUIREMENTS.

No additional work practice requirements exist except as provided in other sections of this permit including Section B (Title V General Requirements) and/or Section E (Source Group Restrictions).

VII. ADDITIONAL REQUIREMENTS.

No additional requirements exist except as provided in other sections of this permit including Section B (Title V General Requirements) and/or Section E (Source Group Restrictions).

*** Permit Shield in Effect. ***

SECTION D. Source Level Requirements

Source ID: 114

Source Name: DIVERTER BOX TO #8 BELT TRANSFER

Source Capacity/Throughput:

0.250 Tons/HR

GYPSUM

Conditions for this source occur in the following groups: 5 - OTHER NESHAP AFFECTED SOURCES

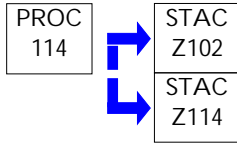
**I. RESTRICTIONS.**

No additional requirements exist except as provided in other sections of this permit including Section B (Title V General Requirements) and/or Section E (Source Group Restrictions).

II. TESTING REQUIREMENTS.

No additional testing requirements exist except as provided in other sections of this permit including Section B (Title V General Requirements) and/or Section E (Source Group Restrictions).

III. MONITORING REQUIREMENTS.

No additional monitoring requirements exist except as provided in other sections of this permit including Section B (Title V General Requirements) and/or Section E (Source Group Restrictions).

IV. RECORDKEEPING REQUIREMENTS.

No additional record keeping requirements exist except as provided in other sections of this permit including Section B (Title V General Requirements) and/or Section E (Source Group Restrictions).

V. REPORTING REQUIREMENTS.

No additional reporting requirements exist except as provided in other sections of this permit including Section B (Title V General Requirements) and/or Section E (Source Group Restrictions).

VI. WORK PRACTICE REQUIREMENTS.

No additional work practice requirements exist except as provided in other sections of this permit including Section B (Title V General Requirements) and/or Section E (Source Group Restrictions).

VII. ADDITIONAL REQUIREMENTS.

No additional requirements exist except as provided in other sections of this permit including Section B (Title V General Requirements) and/or Section E (Source Group Restrictions).

*** Permit Shield in Effect. ***

SECTION D. Source Level Requirements

Source ID: 115

Source Name: TURN HEAD TO #5 SILO TRANSFER

Source Capacity/Throughput:

6.000 Tons/HR

LIMESTONE

Conditions for this source occur in the following groups: 5 - OTHER NESHAP AFFECTED SOURCES

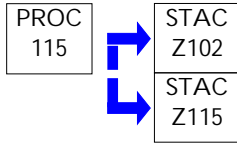
**I. RESTRICTIONS.**

No additional requirements exist except as provided in other sections of this permit including Section B (Title V General Requirements) and/or Section E (Source Group Restrictions).

II. TESTING REQUIREMENTS.

No additional testing requirements exist except as provided in other sections of this permit including Section B (Title V General Requirements) and/or Section E (Source Group Restrictions).

III. MONITORING REQUIREMENTS.

No additional monitoring requirements exist except as provided in other sections of this permit including Section B (Title V General Requirements) and/or Section E (Source Group Restrictions).

IV. RECORDKEEPING REQUIREMENTS.

No additional record keeping requirements exist except as provided in other sections of this permit including Section B (Title V General Requirements) and/or Section E (Source Group Restrictions).

V. REPORTING REQUIREMENTS.

No additional reporting requirements exist except as provided in other sections of this permit including Section B (Title V General Requirements) and/or Section E (Source Group Restrictions).

VI. WORK PRACTICE REQUIREMENTS.

No additional work practice requirements exist except as provided in other sections of this permit including Section B (Title V General Requirements) and/or Section E (Source Group Restrictions).

VII. ADDITIONAL REQUIREMENTS.

No additional requirements exist except as provided in other sections of this permit including Section B (Title V General Requirements) and/or Section E (Source Group Restrictions).

*** Permit Shield in Effect. ***

SECTION D. Source Level Requirements

Source ID: 116

Source Name: DIVERTER BOX TO LIMESTONE BELT TRANSFER

Source Capacity/Throughput: 25.000 Tons/HR LIMESTONE

Conditions for this source occur in the following groups: 5 - OTHER NESHAP AFFECTED SOURCES

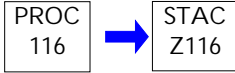
**I. RESTRICTIONS.**

No additional requirements exist except as provided in other sections of this permit including Section B (Title V General Requirements) and/or Section E (Source Group Restrictions).

II. TESTING REQUIREMENTS.

No additional testing requirements exist except as provided in other sections of this permit including Section B (Title V General Requirements) and/or Section E (Source Group Restrictions).

III. MONITORING REQUIREMENTS.

No additional monitoring requirements exist except as provided in other sections of this permit including Section B (Title V General Requirements) and/or Section E (Source Group Restrictions).

IV. RECORDKEEPING REQUIREMENTS.

No additional record keeping requirements exist except as provided in other sections of this permit including Section B (Title V General Requirements) and/or Section E (Source Group Restrictions).

V. REPORTING REQUIREMENTS.

No additional reporting requirements exist except as provided in other sections of this permit including Section B (Title V General Requirements) and/or Section E (Source Group Restrictions).

VI. WORK PRACTICE REQUIREMENTS.

No additional work practice requirements exist except as provided in other sections of this permit including Section B (Title V General Requirements) and/or Section E (Source Group Restrictions).

VII. ADDITIONAL REQUIREMENTS.

No additional requirements exist except as provided in other sections of this permit including Section B (Title V General Requirements) and/or Section E (Source Group Restrictions).

*** Permit Shield in Effect. ***

**SECTION D. Source Level Requirements**

Source ID: 117

Source Name: LIMESTONE BELT TO DIVERTER BOX TRANSFER

Source Capacity/Throughput: 50.000 Tons/HR LIMESTONE

Conditions for this source occur in the following groups: 5 - OTHER NESHAP AFFECTED SOURCES

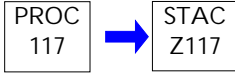
**I. RESTRICTIONS.**

No additional requirements exist except as provided in other sections of this permit including Section B (Title V General Requirements) and/or Section E (Source Group Restrictions).

II. TESTING REQUIREMENTS.

No additional testing requirements exist except as provided in other sections of this permit including Section B (Title V General Requirements) and/or Section E (Source Group Restrictions).

III. MONITORING REQUIREMENTS.

No additional monitoring requirements exist except as provided in other sections of this permit including Section B (Title V General Requirements) and/or Section E (Source Group Restrictions).

IV. RECORDKEEPING REQUIREMENTS.

No additional record keeping requirements exist except as provided in other sections of this permit including Section B (Title V General Requirements) and/or Section E (Source Group Restrictions).

V. REPORTING REQUIREMENTS.

No additional reporting requirements exist except as provided in other sections of this permit including Section B (Title V General Requirements) and/or Section E (Source Group Restrictions).

VI. WORK PRACTICE REQUIREMENTS.

No additional work practice requirements exist except as provided in other sections of this permit including Section B (Title V General Requirements) and/or Section E (Source Group Restrictions).

VII. ADDITIONAL REQUIREMENTS.

No additional requirements exist except as provided in other sections of this permit including Section B (Title V General Requirements) and/or Section E (Source Group Restrictions).

*** Permit Shield in Effect. ***

**SECTION D. Source Level Requirements**

Source ID: 118

Source Name: DIVERTER BOX TO LIMESTONE BELT TRANSFER

Source Capacity/Throughput: 50.000 Tons/HR LIMESTONE

Conditions for this source occur in the following groups: 5 - OTHER NESHAP AFFECTED SOURCES

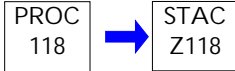
**I. RESTRICTIONS.**

No additional requirements exist except as provided in other sections of this permit including Section B (Title V General Requirements) and/or Section E (Source Group Restrictions).

II. TESTING REQUIREMENTS.

No additional testing requirements exist except as provided in other sections of this permit including Section B (Title V General Requirements) and/or Section E (Source Group Restrictions).

III. MONITORING REQUIREMENTS.

No additional monitoring requirements exist except as provided in other sections of this permit including Section B (Title V General Requirements) and/or Section E (Source Group Restrictions).

IV. RECORDKEEPING REQUIREMENTS.

No additional record keeping requirements exist except as provided in other sections of this permit including Section B (Title V General Requirements) and/or Section E (Source Group Restrictions).

V. REPORTING REQUIREMENTS.

No additional reporting requirements exist except as provided in other sections of this permit including Section B (Title V General Requirements) and/or Section E (Source Group Restrictions).

VI. WORK PRACTICE REQUIREMENTS.

No additional work practice requirements exist except as provided in other sections of this permit including Section B (Title V General Requirements) and/or Section E (Source Group Restrictions).

VII. ADDITIONAL REQUIREMENTS.

No additional requirements exist except as provided in other sections of this permit including Section B (Title V General Requirements) and/or Section E (Source Group Restrictions).

*** Permit Shield in Effect. ***

**SECTION D. Source Level Requirements**

Source ID: 119

Source Name: LIMESTONE BELT TO #1 SILO TRANSFER

Source Capacity/Throughput:

25.000 Tons/HR

LIMESTONE

Conditions for this source occur in the following groups: 5 - OTHER NESHAP AFFECTED SOURCES

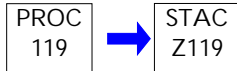
**I. RESTRICTIONS.**

No additional requirements exist except as provided in other sections of this permit including Section B (Title V General Requirements) and/or Section E (Source Group Restrictions).

II. TESTING REQUIREMENTS.

No additional testing requirements exist except as provided in other sections of this permit including Section B (Title V General Requirements) and/or Section E (Source Group Restrictions).

III. MONITORING REQUIREMENTS.

No additional monitoring requirements exist except as provided in other sections of this permit including Section B (Title V General Requirements) and/or Section E (Source Group Restrictions).

IV. RECORDKEEPING REQUIREMENTS.

No additional record keeping requirements exist except as provided in other sections of this permit including Section B (Title V General Requirements) and/or Section E (Source Group Restrictions).

V. REPORTING REQUIREMENTS.

No additional reporting requirements exist except as provided in other sections of this permit including Section B (Title V General Requirements) and/or Section E (Source Group Restrictions).

VI. WORK PRACTICE REQUIREMENTS.

No additional work practice requirements exist except as provided in other sections of this permit including Section B (Title V General Requirements) and/or Section E (Source Group Restrictions).

VII. ADDITIONAL REQUIREMENTS.

No additional requirements exist except as provided in other sections of this permit including Section B (Title V General Requirements) and/or Section E (Source Group Restrictions).

*** Permit Shield in Effect. ***

SECTION D. Source Level Requirements

Source ID: 120

Source Name: DIVERTER BOX TO #2 SILO TRANSFER

Source Capacity/Throughput:

25.000 Tons/HR

LIMESTONE

Conditions for this source occur in the following groups: 5 - OTHER NESHAP AFFECTED SOURCES

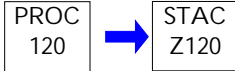
**I. RESTRICTIONS.**

No additional requirements exist except as provided in other sections of this permit including Section B (Title V General Requirements) and/or Section E (Source Group Restrictions).

II. TESTING REQUIREMENTS.

No additional testing requirements exist except as provided in other sections of this permit including Section B (Title V General Requirements) and/or Section E (Source Group Restrictions).

III. MONITORING REQUIREMENTS.

No additional monitoring requirements exist except as provided in other sections of this permit including Section B (Title V General Requirements) and/or Section E (Source Group Restrictions).

IV. RECORDKEEPING REQUIREMENTS.

No additional record keeping requirements exist except as provided in other sections of this permit including Section B (Title V General Requirements) and/or Section E (Source Group Restrictions).

V. REPORTING REQUIREMENTS.

No additional reporting requirements exist except as provided in other sections of this permit including Section B (Title V General Requirements) and/or Section E (Source Group Restrictions).

VI. WORK PRACTICE REQUIREMENTS.

No additional work practice requirements exist except as provided in other sections of this permit including Section B (Title V General Requirements) and/or Section E (Source Group Restrictions).

VII. ADDITIONAL REQUIREMENTS.

No additional requirements exist except as provided in other sections of this permit including Section B (Title V General Requirements) and/or Section E (Source Group Restrictions).

*** Permit Shield in Effect. ***

**SECTION D. Source Level Requirements**

Source ID: 121

Source Name: DIVERTER BOX TO #8 SILO TRANSFER

Source Capacity/Throughput:

20.000 Tons/HR

LIMESTONE

Conditions for this source occur in the following groups: 5 - OTHER NESHAP AFFECTED SOURCES

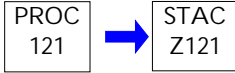
**I. RESTRICTIONS.**

No additional requirements exist except as provided in other sections of this permit including Section B (Title V General Requirements) and/or Section E (Source Group Restrictions).

II. TESTING REQUIREMENTS.

No additional testing requirements exist except as provided in other sections of this permit including Section B (Title V General Requirements) and/or Section E (Source Group Restrictions).

III. MONITORING REQUIREMENTS.

No additional monitoring requirements exist except as provided in other sections of this permit including Section B (Title V General Requirements) and/or Section E (Source Group Restrictions).

IV. RECORDKEEPING REQUIREMENTS.

No additional record keeping requirements exist except as provided in other sections of this permit including Section B (Title V General Requirements) and/or Section E (Source Group Restrictions).

V. REPORTING REQUIREMENTS.

No additional reporting requirements exist except as provided in other sections of this permit including Section B (Title V General Requirements) and/or Section E (Source Group Restrictions).

VI. WORK PRACTICE REQUIREMENTS.

No additional work practice requirements exist except as provided in other sections of this permit including Section B (Title V General Requirements) and/or Section E (Source Group Restrictions).

VII. ADDITIONAL REQUIREMENTS.

No additional requirements exist except as provided in other sections of this permit including Section B (Title V General Requirements) and/or Section E (Source Group Restrictions).

*** Permit Shield in Effect. ***

**SECTION D. Source Level Requirements**

Source ID: 122

Source Name: TURNHEAD TO #7 SILO TRANSFER

Source Capacity/Throughput:

20.000 Tons/HR

LIMESTONE

Conditions for this source occur in the following groups: 5 - OTHER NESHAP AFFECTED SOURCES

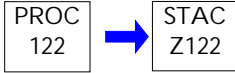
**I. RESTRICTIONS.**

No additional requirements exist except as provided in other sections of this permit including Section B (Title V General Requirements) and/or Section E (Source Group Restrictions).

II. TESTING REQUIREMENTS.

No additional testing requirements exist except as provided in other sections of this permit including Section B (Title V General Requirements) and/or Section E (Source Group Restrictions).

III. MONITORING REQUIREMENTS.

No additional monitoring requirements exist except as provided in other sections of this permit including Section B (Title V General Requirements) and/or Section E (Source Group Restrictions).

IV. RECORDKEEPING REQUIREMENTS.

No additional record keeping requirements exist except as provided in other sections of this permit including Section B (Title V General Requirements) and/or Section E (Source Group Restrictions).

V. REPORTING REQUIREMENTS.

No additional reporting requirements exist except as provided in other sections of this permit including Section B (Title V General Requirements) and/or Section E (Source Group Restrictions).

VI. WORK PRACTICE REQUIREMENTS.

No additional work practice requirements exist except as provided in other sections of this permit including Section B (Title V General Requirements) and/or Section E (Source Group Restrictions).

VII. ADDITIONAL REQUIREMENTS.

No additional requirements exist except as provided in other sections of this permit including Section B (Title V General Requirements) and/or Section E (Source Group Restrictions).

*** Permit Shield in Effect. ***

**SECTION D. Source Level Requirements**

Source ID: 123

Source Name: TURNHEAD TO #12 SILO TRANSFER

Source Capacity/Throughput: 13.000 Tons/HR LIMESTONE

Conditions for this source occur in the following groups: 5 - OTHER NESHAP AFFECTED SOURCES

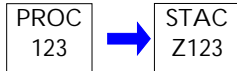
**I. RESTRICTIONS.**

No additional requirements exist except as provided in other sections of this permit including Section B (Title V General Requirements) and/or Section E (Source Group Restrictions).

II. TESTING REQUIREMENTS.

No additional testing requirements exist except as provided in other sections of this permit including Section B (Title V General Requirements) and/or Section E (Source Group Restrictions).

III. MONITORING REQUIREMENTS.

No additional monitoring requirements exist except as provided in other sections of this permit including Section B (Title V General Requirements) and/or Section E (Source Group Restrictions).

IV. RECORDKEEPING REQUIREMENTS.

No additional record keeping requirements exist except as provided in other sections of this permit including Section B (Title V General Requirements) and/or Section E (Source Group Restrictions).

V. REPORTING REQUIREMENTS.

No additional reporting requirements exist except as provided in other sections of this permit including Section B (Title V General Requirements) and/or Section E (Source Group Restrictions).

VI. WORK PRACTICE REQUIREMENTS.

No additional work practice requirements exist except as provided in other sections of this permit including Section B (Title V General Requirements) and/or Section E (Source Group Restrictions).

VII. ADDITIONAL REQUIREMENTS.

No additional requirements exist except as provided in other sections of this permit including Section B (Title V General Requirements) and/or Section E (Source Group Restrictions).

*** Permit Shield in Effect. ***

**SECTION D. Source Level Requirements**

Source ID: 124

Source Name: TURNHEAD TO #11 SILO TRANSFER

Source Capacity/Throughput:

13.000 Tons/HR

LIMESTONE

Conditions for this source occur in the following groups: 5 - OTHER NESHAP AFFECTED SOURCES

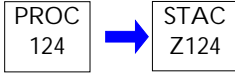
**I. RESTRICTIONS.**

No additional requirements exist except as provided in other sections of this permit including Section B (Title V General Requirements) and/or Section E (Source Group Restrictions).

II. TESTING REQUIREMENTS.

No additional testing requirements exist except as provided in other sections of this permit including Section B (Title V General Requirements) and/or Section E (Source Group Restrictions).

III. MONITORING REQUIREMENTS.

No additional monitoring requirements exist except as provided in other sections of this permit including Section B (Title V General Requirements) and/or Section E (Source Group Restrictions).

IV. RECORDKEEPING REQUIREMENTS.

No additional record keeping requirements exist except as provided in other sections of this permit including Section B (Title V General Requirements) and/or Section E (Source Group Restrictions).

V. REPORTING REQUIREMENTS.

No additional reporting requirements exist except as provided in other sections of this permit including Section B (Title V General Requirements) and/or Section E (Source Group Restrictions).

VI. WORK PRACTICE REQUIREMENTS.

No additional work practice requirements exist except as provided in other sections of this permit including Section B (Title V General Requirements) and/or Section E (Source Group Restrictions).

VII. ADDITIONAL REQUIREMENTS.

No additional requirements exist except as provided in other sections of this permit including Section B (Title V General Requirements) and/or Section E (Source Group Restrictions).

*** Permit Shield in Effect. ***

**SECTION D. Source Level Requirements**

Source ID: 125

Source Name: TURNHEAD TO #10 SILO TRANSFER

Source Capacity/Throughput:

13.000 Tons/HR

LIMESTONE

Conditions for this source occur in the following groups: 5 - OTHER NESHAP AFFECTED SOURCES

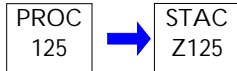
**I. RESTRICTIONS.**

No additional requirements exist except as provided in other sections of this permit including Section B (Title V General Requirements) and/or Section E (Source Group Restrictions).

II. TESTING REQUIREMENTS.

No additional testing requirements exist except as provided in other sections of this permit including Section B (Title V General Requirements) and/or Section E (Source Group Restrictions).

III. MONITORING REQUIREMENTS.

No additional monitoring requirements exist except as provided in other sections of this permit including Section B (Title V General Requirements) and/or Section E (Source Group Restrictions).

IV. RECORDKEEPING REQUIREMENTS.

No additional record keeping requirements exist except as provided in other sections of this permit including Section B (Title V General Requirements) and/or Section E (Source Group Restrictions).

V. REPORTING REQUIREMENTS.

No additional reporting requirements exist except as provided in other sections of this permit including Section B (Title V General Requirements) and/or Section E (Source Group Restrictions).

VI. WORK PRACTICE REQUIREMENTS.

No additional work practice requirements exist except as provided in other sections of this permit including Section B (Title V General Requirements) and/or Section E (Source Group Restrictions).

VII. ADDITIONAL REQUIREMENTS.

No additional requirements exist except as provided in other sections of this permit including Section B (Title V General Requirements) and/or Section E (Source Group Restrictions).

*** Permit Shield in Effect. ***

**SECTION D. Source Level Requirements**

Source ID: 126

Source Name: DIVERTER BOX TO SHALE BELT TRANSFER

Source Capacity/Throughput: 15.000 Tons/HR SHALE

Conditions for this source occur in the following groups: 5 - OTHER NESHAP AFFECTED SOURCES

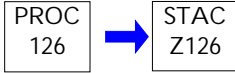
**I. RESTRICTIONS.**

No additional requirements exist except as provided in other sections of this permit including Section B (Title V General Requirements) and/or Section E (Source Group Restrictions).

II. TESTING REQUIREMENTS.

No additional testing requirements exist except as provided in other sections of this permit including Section B (Title V General Requirements) and/or Section E (Source Group Restrictions).

III. MONITORING REQUIREMENTS.

No additional monitoring requirements exist except as provided in other sections of this permit including Section B (Title V General Requirements) and/or Section E (Source Group Restrictions).

IV. RECORDKEEPING REQUIREMENTS.

No additional record keeping requirements exist except as provided in other sections of this permit including Section B (Title V General Requirements) and/or Section E (Source Group Restrictions).

V. REPORTING REQUIREMENTS.

No additional reporting requirements exist except as provided in other sections of this permit including Section B (Title V General Requirements) and/or Section E (Source Group Restrictions).

VI. WORK PRACTICE REQUIREMENTS.

No additional work practice requirements exist except as provided in other sections of this permit including Section B (Title V General Requirements) and/or Section E (Source Group Restrictions).

VII. ADDITIONAL REQUIREMENTS.

No additional requirements exist except as provided in other sections of this permit including Section B (Title V General Requirements) and/or Section E (Source Group Restrictions).

*** Permit Shield in Effect. ***

**SECTION D. Source Level Requirements**

Source ID: 127

Source Name: DIVERTER BOX TO SAND BELT TRANSFER

Source Capacity/Throughput: 1.600 Tons/HR SAND/GRAVEL

Conditions for this source occur in the following groups: 5 - OTHER NESHAP AFFECTED SOURCES

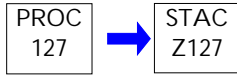
**I. RESTRICTIONS.**

No additional requirements exist except as provided in other sections of this permit including Section B (Title V General Requirements) and/or Section E (Source Group Restrictions).

II. TESTING REQUIREMENTS.

No additional testing requirements exist except as provided in other sections of this permit including Section B (Title V General Requirements) and/or Section E (Source Group Restrictions).

III. MONITORING REQUIREMENTS.

No additional monitoring requirements exist except as provided in other sections of this permit including Section B (Title V General Requirements) and/or Section E (Source Group Restrictions).

IV. RECORDKEEPING REQUIREMENTS.

No additional record keeping requirements exist except as provided in other sections of this permit including Section B (Title V General Requirements) and/or Section E (Source Group Restrictions).

V. REPORTING REQUIREMENTS.

No additional reporting requirements exist except as provided in other sections of this permit including Section B (Title V General Requirements) and/or Section E (Source Group Restrictions).

VI. WORK PRACTICE REQUIREMENTS.

No additional work practice requirements exist except as provided in other sections of this permit including Section B (Title V General Requirements) and/or Section E (Source Group Restrictions).

VII. ADDITIONAL REQUIREMENTS.

No additional requirements exist except as provided in other sections of this permit including Section B (Title V General Requirements) and/or Section E (Source Group Restrictions).

*** Permit Shield in Effect. ***

**SECTION D. Source Level Requirements**

Source ID: 128

Source Name: SAND BELT TO #3 SILO TRANSFER

Source Capacity/Throughput: 1.600 Tons/HR SAND/GRAVEL

Conditions for this source occur in the following groups: 5 - OTHER NESHAP AFFECTED SOURCES

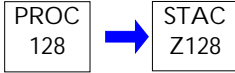
**I. RESTRICTIONS.**

No additional requirements exist except as provided in other sections of this permit including Section B (Title V General Requirements) and/or Section E (Source Group Restrictions).

II. TESTING REQUIREMENTS.

No additional testing requirements exist except as provided in other sections of this permit including Section B (Title V General Requirements) and/or Section E (Source Group Restrictions).

III. MONITORING REQUIREMENTS.

No additional monitoring requirements exist except as provided in other sections of this permit including Section B (Title V General Requirements) and/or Section E (Source Group Restrictions).

IV. RECORDKEEPING REQUIREMENTS.

No additional record keeping requirements exist except as provided in other sections of this permit including Section B (Title V General Requirements) and/or Section E (Source Group Restrictions).

V. REPORTING REQUIREMENTS.

No additional reporting requirements exist except as provided in other sections of this permit including Section B (Title V General Requirements) and/or Section E (Source Group Restrictions).

VI. WORK PRACTICE REQUIREMENTS.

No additional work practice requirements exist except as provided in other sections of this permit including Section B (Title V General Requirements) and/or Section E (Source Group Restrictions).

VII. ADDITIONAL REQUIREMENTS.

No additional requirements exist except as provided in other sections of this permit including Section B (Title V General Requirements) and/or Section E (Source Group Restrictions).

*** Permit Shield in Effect. ***

**SECTION D. Source Level Requirements**

Source ID: 129

Source Name: #8 BELT TO #9 BELT TRANSFER

Source Capacity/Throughput:

0.250 Tons/HR

GYPSUM

Conditions for this source occur in the following groups: 5 - OTHER NESHAP AFFECTED SOURCES

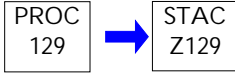
**I. RESTRICTIONS.**

No additional requirements exist except as provided in other sections of this permit including Section B (Title V General Requirements) and/or Section E (Source Group Restrictions).

II. TESTING REQUIREMENTS.

No additional testing requirements exist except as provided in other sections of this permit including Section B (Title V General Requirements) and/or Section E (Source Group Restrictions).

III. MONITORING REQUIREMENTS.

No additional monitoring requirements exist except as provided in other sections of this permit including Section B (Title V General Requirements) and/or Section E (Source Group Restrictions).

IV. RECORDKEEPING REQUIREMENTS.

No additional record keeping requirements exist except as provided in other sections of this permit including Section B (Title V General Requirements) and/or Section E (Source Group Restrictions).

V. REPORTING REQUIREMENTS.

No additional reporting requirements exist except as provided in other sections of this permit including Section B (Title V General Requirements) and/or Section E (Source Group Restrictions).

VI. WORK PRACTICE REQUIREMENTS.

No additional work practice requirements exist except as provided in other sections of this permit including Section B (Title V General Requirements) and/or Section E (Source Group Restrictions).

VII. ADDITIONAL REQUIREMENTS.

No additional requirements exist except as provided in other sections of this permit including Section B (Title V General Requirements) and/or Section E (Source Group Restrictions).

*** Permit Shield in Effect. ***

**SECTION D. Source Level Requirements**

Source ID: 130

Source Name: #9 BELT TO #6 SILO TRANSFER

Source Capacity/Throughput:

0.115 Tons/HR

GYPSUM

Conditions for this source occur in the following groups: 5 - OTHER NESHAP AFFECTED SOURCES

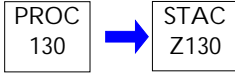
**I. RESTRICTIONS.**

No additional requirements exist except as provided in other sections of this permit including Section B (Title V General Requirements) and/or Section E (Source Group Restrictions).

II. TESTING REQUIREMENTS.

No additional testing requirements exist except as provided in other sections of this permit including Section B (Title V General Requirements) and/or Section E (Source Group Restrictions).

III. MONITORING REQUIREMENTS.

No additional monitoring requirements exist except as provided in other sections of this permit including Section B (Title V General Requirements) and/or Section E (Source Group Restrictions).

IV. RECORDKEEPING REQUIREMENTS.

No additional record keeping requirements exist except as provided in other sections of this permit including Section B (Title V General Requirements) and/or Section E (Source Group Restrictions).

V. REPORTING REQUIREMENTS.

No additional reporting requirements exist except as provided in other sections of this permit including Section B (Title V General Requirements) and/or Section E (Source Group Restrictions).

VI. WORK PRACTICE REQUIREMENTS.

No additional work practice requirements exist except as provided in other sections of this permit including Section B (Title V General Requirements) and/or Section E (Source Group Restrictions).

VII. ADDITIONAL REQUIREMENTS.

No additional requirements exist except as provided in other sections of this permit including Section B (Title V General Requirements) and/or Section E (Source Group Restrictions).

*** Permit Shield in Effect. ***

**SECTION D. Source Level Requirements**

Source ID: 131

Source Name: CLINKER BELT TO CLINKER SILO TRANSFER

Source Capacity/Throughput: 32.000 Tons/HR CLINKER

Conditions for this source occur in the following groups: 1B - SOURCES WITH NEW BAGHOUSES
5 - OTHER NESHAP AFFECTED SOURCES

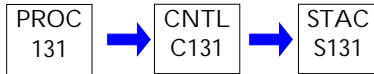
**I. RESTRICTIONS.**

No additional requirements exist except as provided in other sections of this permit including Section B (Title V General Requirements) and/or Section E (Source Group Restrictions).

II. TESTING REQUIREMENTS.

No additional testing requirements exist except as provided in other sections of this permit including Section B (Title V General Requirements) and/or Section E (Source Group Restrictions).

III. MONITORING REQUIREMENTS.

No additional monitoring requirements exist except as provided in other sections of this permit including Section B (Title V General Requirements) and/or Section E (Source Group Restrictions).

IV. RECORDKEEPING REQUIREMENTS.

No additional record keeping requirements exist except as provided in other sections of this permit including Section B (Title V General Requirements) and/or Section E (Source Group Restrictions).

V. REPORTING REQUIREMENTS.

No additional reporting requirements exist except as provided in other sections of this permit including Section B (Title V General Requirements) and/or Section E (Source Group Restrictions).

VI. WORK PRACTICE REQUIREMENTS.

No additional work practice requirements exist except as provided in other sections of this permit including Section B (Title V General Requirements) and/or Section E (Source Group Restrictions).

VII. ADDITIONAL REQUIREMENTS.

No additional requirements exist except as provided in other sections of this permit including Section B (Title V General Requirements) and/or Section E (Source Group Restrictions).

*** Permit Shield in Effect. ***

**SECTION D. Source Level Requirements**

Source ID: 132

Source Name: TURNHEAD TO STOKER COAL SILO TRANSFER

Source Capacity/Throughput: 0.250 Tons/HR COAL

Conditions for this source occur in the following groups: 5 - OTHER NESHAP AFFECTED SOURCES

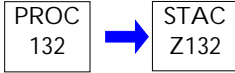
**I. RESTRICTIONS.**

No additional requirements exist except as provided in other sections of this permit including Section B (Title V General Requirements) and/or Section E (Source Group Restrictions).

II. TESTING REQUIREMENTS.

No additional testing requirements exist except as provided in other sections of this permit including Section B (Title V General Requirements) and/or Section E (Source Group Restrictions).

III. MONITORING REQUIREMENTS.

No additional monitoring requirements exist except as provided in other sections of this permit including Section B (Title V General Requirements) and/or Section E (Source Group Restrictions).

IV. RECORDKEEPING REQUIREMENTS.

No additional record keeping requirements exist except as provided in other sections of this permit including Section B (Title V General Requirements) and/or Section E (Source Group Restrictions).

V. REPORTING REQUIREMENTS.

No additional reporting requirements exist except as provided in other sections of this permit including Section B (Title V General Requirements) and/or Section E (Source Group Restrictions).

VI. WORK PRACTICE REQUIREMENTS.

No additional work practice requirements exist except as provided in other sections of this permit including Section B (Title V General Requirements) and/or Section E (Source Group Restrictions).

VII. ADDITIONAL REQUIREMENTS.

No additional requirements exist except as provided in other sections of this permit including Section B (Title V General Requirements) and/or Section E (Source Group Restrictions).

*** Permit Shield in Effect. ***

**SECTION D. Source Level Requirements**

Source ID: 133 Source Name: DIVERTER BOX TO #9 SILO TRANSFER
 Source Capacity/Throughput: 1.600 Tons/HR SAND/GRAVEL

Conditions for this source occur in the following groups: 5 - OTHER NESHAP AFFECTED SOURCES

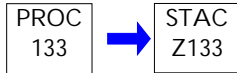
**I. RESTRICTIONS.**

No additional requirements exist except as provided in other sections of this permit including Section B (Title V General Requirements) and/or Section E (Source Group Restrictions).

II. TESTING REQUIREMENTS.

No additional testing requirements exist except as provided in other sections of this permit including Section B (Title V General Requirements) and/or Section E (Source Group Restrictions).

III. MONITORING REQUIREMENTS.

No additional monitoring requirements exist except as provided in other sections of this permit including Section B (Title V General Requirements) and/or Section E (Source Group Restrictions).

IV. RECORDKEEPING REQUIREMENTS.

No additional record keeping requirements exist except as provided in other sections of this permit including Section B (Title V General Requirements) and/or Section E (Source Group Restrictions).

V. REPORTING REQUIREMENTS.

No additional reporting requirements exist except as provided in other sections of this permit including Section B (Title V General Requirements) and/or Section E (Source Group Restrictions).

VI. WORK PRACTICE REQUIREMENTS.

No additional work practice requirements exist except as provided in other sections of this permit including Section B (Title V General Requirements) and/or Section E (Source Group Restrictions).

VII. ADDITIONAL REQUIREMENTS.

No additional requirements exist except as provided in other sections of this permit including Section B (Title V General Requirements) and/or Section E (Source Group Restrictions).

*** Permit Shield in Effect. ***

**SECTION D. Source Level Requirements**

Source ID: 134

Source Name: SHALE BELT TO SHALE SILO TRANSFER

Source Capacity/Throughput: 15.000 Tons/HR SHALE

Conditions for this source occur in the following groups: 5 - OTHER NESHAP AFFECTED SOURCES

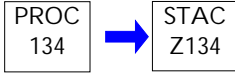
**I. RESTRICTIONS.**

No additional requirements exist except as provided in other sections of this permit including Section B (Title V General Requirements) and/or Section E (Source Group Restrictions).

II. TESTING REQUIREMENTS.

No additional testing requirements exist except as provided in other sections of this permit including Section B (Title V General Requirements) and/or Section E (Source Group Restrictions).

III. MONITORING REQUIREMENTS.

No additional monitoring requirements exist except as provided in other sections of this permit including Section B (Title V General Requirements) and/or Section E (Source Group Restrictions).

IV. RECORDKEEPING REQUIREMENTS.

No additional record keeping requirements exist except as provided in other sections of this permit including Section B (Title V General Requirements) and/or Section E (Source Group Restrictions).

V. REPORTING REQUIREMENTS.

No additional reporting requirements exist except as provided in other sections of this permit including Section B (Title V General Requirements) and/or Section E (Source Group Restrictions).

VI. WORK PRACTICE REQUIREMENTS.

No additional work practice requirements exist except as provided in other sections of this permit including Section B (Title V General Requirements) and/or Section E (Source Group Restrictions).

VII. ADDITIONAL REQUIREMENTS.

No additional requirements exist except as provided in other sections of this permit including Section B (Title V General Requirements) and/or Section E (Source Group Restrictions).

*** Permit Shield in Effect. ***

**SECTION D. Source Level Requirements**

Source ID: 135

Source Name: TURNHEAD TO IRON SILO TRANSFER

Source Capacity/Throughput: 0.100 Tons/HR IRON

Conditions for this source occur in the following groups: 5 - OTHER NESHAP AFFECTED SOURCES

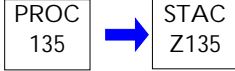
**I. RESTRICTIONS.**

No additional requirements exist except as provided in other sections of this permit including Section B (Title V General Requirements) and/or Section E (Source Group Restrictions).

II. TESTING REQUIREMENTS.

No additional testing requirements exist except as provided in other sections of this permit including Section B (Title V General Requirements) and/or Section E (Source Group Restrictions).

III. MONITORING REQUIREMENTS.

No additional monitoring requirements exist except as provided in other sections of this permit including Section B (Title V General Requirements) and/or Section E (Source Group Restrictions).

IV. RECORDKEEPING REQUIREMENTS.

No additional record keeping requirements exist except as provided in other sections of this permit including Section B (Title V General Requirements) and/or Section E (Source Group Restrictions).

V. REPORTING REQUIREMENTS.

No additional reporting requirements exist except as provided in other sections of this permit including Section B (Title V General Requirements) and/or Section E (Source Group Restrictions).

VI. WORK PRACTICE REQUIREMENTS.

No additional work practice requirements exist except as provided in other sections of this permit including Section B (Title V General Requirements) and/or Section E (Source Group Restrictions).

VII. ADDITIONAL REQUIREMENTS.

No additional requirements exist except as provided in other sections of this permit including Section B (Title V General Requirements) and/or Section E (Source Group Restrictions).

*** Permit Shield in Effect. ***

**SECTION D. Source Level Requirements**

Source ID: 136

Source Name: #1 SILO FEEDER

Source Capacity/Throughput:

25.000 Tons/HR

LIMESTONE

Conditions for this source occur in the following groups: 5 - OTHER NESHP AFFECTED SOURCES

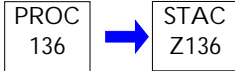
**I. RESTRICTIONS.**

No additional requirements exist except as provided in other sections of this permit including Section B (Title V General Requirements) and/or Section E (Source Group Restrictions).

II. TESTING REQUIREMENTS.

No additional testing requirements exist except as provided in other sections of this permit including Section B (Title V General Requirements) and/or Section E (Source Group Restrictions).

III. MONITORING REQUIREMENTS.

No additional monitoring requirements exist except as provided in other sections of this permit including Section B (Title V General Requirements) and/or Section E (Source Group Restrictions).

IV. RECORDKEEPING REQUIREMENTS.

No additional record keeping requirements exist except as provided in other sections of this permit including Section B (Title V General Requirements) and/or Section E (Source Group Restrictions).

V. REPORTING REQUIREMENTS.

No additional reporting requirements exist except as provided in other sections of this permit including Section B (Title V General Requirements) and/or Section E (Source Group Restrictions).

VI. WORK PRACTICE REQUIREMENTS.

No additional work practice requirements exist except as provided in other sections of this permit including Section B (Title V General Requirements) and/or Section E (Source Group Restrictions).

VII. ADDITIONAL REQUIREMENTS.

No additional requirements exist except as provided in other sections of this permit including Section B (Title V General Requirements) and/or Section E (Source Group Restrictions).

*** Permit Shield in Effect. ***

**SECTION D. Source Level Requirements**

Source ID: 137

Source Name: #2 SILO FEEDER

Source Capacity/Throughput:

25.000 Tons/HR

LIMESTONE

Conditions for this source occur in the following groups: 5 - OTHER NESHP AFFECTED SOURCES

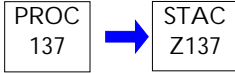
**I. RESTRICTIONS.**

No additional requirements exist except as provided in other sections of this permit including Section B (Title V General Requirements) and/or Section E (Source Group Restrictions).

II. TESTING REQUIREMENTS.

No additional testing requirements exist except as provided in other sections of this permit including Section B (Title V General Requirements) and/or Section E (Source Group Restrictions).

III. MONITORING REQUIREMENTS.

No additional monitoring requirements exist except as provided in other sections of this permit including Section B (Title V General Requirements) and/or Section E (Source Group Restrictions).

IV. RECORDKEEPING REQUIREMENTS.

No additional record keeping requirements exist except as provided in other sections of this permit including Section B (Title V General Requirements) and/or Section E (Source Group Restrictions).

V. REPORTING REQUIREMENTS.

No additional reporting requirements exist except as provided in other sections of this permit including Section B (Title V General Requirements) and/or Section E (Source Group Restrictions).

VI. WORK PRACTICE REQUIREMENTS.

No additional work practice requirements exist except as provided in other sections of this permit including Section B (Title V General Requirements) and/or Section E (Source Group Restrictions).

VII. ADDITIONAL REQUIREMENTS.

No additional requirements exist except as provided in other sections of this permit including Section B (Title V General Requirements) and/or Section E (Source Group Restrictions).

*** Permit Shield in Effect. ***

**SECTION D. Source Level Requirements**

Source ID: 138

Source Name: #3 SILO FEEDER

Source Capacity/Throughput: 1.600 Tons/HR SAND/GRAVEL

Conditions for this source occur in the following groups: 5 - OTHER NESHAP AFFECTED SOURCES

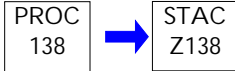
**I. RESTRICTIONS.**

No additional requirements exist except as provided in other sections of this permit including Section B (Title V General Requirements) and/or Section E (Source Group Restrictions).

II. TESTING REQUIREMENTS.

No additional testing requirements exist except as provided in other sections of this permit including Section B (Title V General Requirements) and/or Section E (Source Group Restrictions).

III. MONITORING REQUIREMENTS.

No additional monitoring requirements exist except as provided in other sections of this permit including Section B (Title V General Requirements) and/or Section E (Source Group Restrictions).

IV. RECORDKEEPING REQUIREMENTS.

No additional record keeping requirements exist except as provided in other sections of this permit including Section B (Title V General Requirements) and/or Section E (Source Group Restrictions).

V. REPORTING REQUIREMENTS.

No additional reporting requirements exist except as provided in other sections of this permit including Section B (Title V General Requirements) and/or Section E (Source Group Restrictions).

VI. WORK PRACTICE REQUIREMENTS.

No additional work practice requirements exist except as provided in other sections of this permit including Section B (Title V General Requirements) and/or Section E (Source Group Restrictions).

VII. ADDITIONAL REQUIREMENTS.

No additional requirements exist except as provided in other sections of this permit including Section B (Title V General Requirements) and/or Section E (Source Group Restrictions).

*** Permit Shield in Effect. ***

**SECTION D. Source Level Requirements**

Source ID: 139

Source Name: #8 SILO FEEDER

Source Capacity/Throughput:

20.000 Tons/HR

LIMESTONE

Conditions for this source occur in the following groups: 5 - OTHER NESHP AFFECTED SOURCES

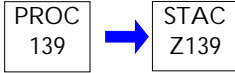
**I. RESTRICTIONS.**

No additional requirements exist except as provided in other sections of this permit including Section B (Title V General Requirements) and/or Section E (Source Group Restrictions).

II. TESTING REQUIREMENTS.

No additional testing requirements exist except as provided in other sections of this permit including Section B (Title V General Requirements) and/or Section E (Source Group Restrictions).

III. MONITORING REQUIREMENTS.

No additional monitoring requirements exist except as provided in other sections of this permit including Section B (Title V General Requirements) and/or Section E (Source Group Restrictions).

IV. RECORDKEEPING REQUIREMENTS.

No additional record keeping requirements exist except as provided in other sections of this permit including Section B (Title V General Requirements) and/or Section E (Source Group Restrictions).

V. REPORTING REQUIREMENTS.

No additional reporting requirements exist except as provided in other sections of this permit including Section B (Title V General Requirements) and/or Section E (Source Group Restrictions).

VI. WORK PRACTICE REQUIREMENTS.

No additional work practice requirements exist except as provided in other sections of this permit including Section B (Title V General Requirements) and/or Section E (Source Group Restrictions).

VII. ADDITIONAL REQUIREMENTS.

No additional requirements exist except as provided in other sections of this permit including Section B (Title V General Requirements) and/or Section E (Source Group Restrictions).

*** Permit Shield in Effect. ***

SECTION D. Source Level Requirements

Source ID: 140

Source Name: IRON SILO #1 FEEDER

Source Capacity/Throughput: 0.050 Tons/HR IRON

Conditions for this source occur in the following groups: 5 - OTHER NESHAP AFFECTED SOURCES

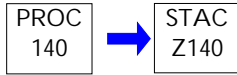
**I. RESTRICTIONS.**

No additional requirements exist except as provided in other sections of this permit including Section B (Title V General Requirements) and/or Section E (Source Group Restrictions).

II. TESTING REQUIREMENTS.

No additional testing requirements exist except as provided in other sections of this permit including Section B (Title V General Requirements) and/or Section E (Source Group Restrictions).

III. MONITORING REQUIREMENTS.

No additional monitoring requirements exist except as provided in other sections of this permit including Section B (Title V General Requirements) and/or Section E (Source Group Restrictions).

IV. RECORDKEEPING REQUIREMENTS.

No additional record keeping requirements exist except as provided in other sections of this permit including Section B (Title V General Requirements) and/or Section E (Source Group Restrictions).

V. REPORTING REQUIREMENTS.

No additional reporting requirements exist except as provided in other sections of this permit including Section B (Title V General Requirements) and/or Section E (Source Group Restrictions).

VI. WORK PRACTICE REQUIREMENTS.

No additional work practice requirements exist except as provided in other sections of this permit including Section B (Title V General Requirements) and/or Section E (Source Group Restrictions).

VII. ADDITIONAL REQUIREMENTS.

No additional requirements exist except as provided in other sections of this permit including Section B (Title V General Requirements) and/or Section E (Source Group Restrictions).

*** Permit Shield in Effect. ***

SECTION D. Source Level Requirements

Source ID: 141

Source Name: IRON SILO #2 FEEDER

Source Capacity/Throughput: 0.050 Tons/HR IRON

Conditions for this source occur in the following groups: 5 - OTHER NESHAP AFFECTED SOURCES

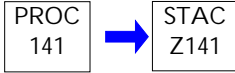
**I. RESTRICTIONS.**

No additional requirements exist except as provided in other sections of this permit including Section B (Title V General Requirements) and/or Section E (Source Group Restrictions).

II. TESTING REQUIREMENTS.

No additional testing requirements exist except as provided in other sections of this permit including Section B (Title V General Requirements) and/or Section E (Source Group Restrictions).

III. MONITORING REQUIREMENTS.

No additional monitoring requirements exist except as provided in other sections of this permit including Section B (Title V General Requirements) and/or Section E (Source Group Restrictions).

IV. RECORDKEEPING REQUIREMENTS.

No additional record keeping requirements exist except as provided in other sections of this permit including Section B (Title V General Requirements) and/or Section E (Source Group Restrictions).

V. REPORTING REQUIREMENTS.

No additional reporting requirements exist except as provided in other sections of this permit including Section B (Title V General Requirements) and/or Section E (Source Group Restrictions).

VI. WORK PRACTICE REQUIREMENTS.

No additional work practice requirements exist except as provided in other sections of this permit including Section B (Title V General Requirements) and/or Section E (Source Group Restrictions).

VII. ADDITIONAL REQUIREMENTS.

No additional requirements exist except as provided in other sections of this permit including Section B (Title V General Requirements) and/or Section E (Source Group Restrictions).

*** Permit Shield in Effect. ***

**SECTION D. Source Level Requirements**

Source ID: 142

Source Name: #6 SILO TRANSFER

Source Capacity/Throughput:

0.115 Tons/HR

GYPSUM

Conditions for this source occur in the following groups: 5 - OTHER NESHAP AFFECTED SOURCES

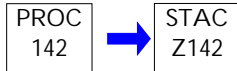
**I. RESTRICTIONS.**

No additional requirements exist except as provided in other sections of this permit including Section B (Title V General Requirements) and/or Section E (Source Group Restrictions).

II. TESTING REQUIREMENTS.

No additional testing requirements exist except as provided in other sections of this permit including Section B (Title V General Requirements) and/or Section E (Source Group Restrictions).

III. MONITORING REQUIREMENTS.

No additional monitoring requirements exist except as provided in other sections of this permit including Section B (Title V General Requirements) and/or Section E (Source Group Restrictions).

IV. RECORDKEEPING REQUIREMENTS.

No additional record keeping requirements exist except as provided in other sections of this permit including Section B (Title V General Requirements) and/or Section E (Source Group Restrictions).

V. REPORTING REQUIREMENTS.

No additional reporting requirements exist except as provided in other sections of this permit including Section B (Title V General Requirements) and/or Section E (Source Group Restrictions).

VI. WORK PRACTICE REQUIREMENTS.

No additional work practice requirements exist except as provided in other sections of this permit including Section B (Title V General Requirements) and/or Section E (Source Group Restrictions).

VII. ADDITIONAL REQUIREMENTS.

No additional requirements exist except as provided in other sections of this permit including Section B (Title V General Requirements) and/or Section E (Source Group Restrictions).

*** Permit Shield in Effect. ***

**SECTION D. Source Level Requirements**

Source ID: 143

Source Name: #7 SILO FEEDER

Source Capacity/Throughput:

20.000 Tons/HR

LIMESTONE

Conditions for this source occur in the following groups: 5 - OTHER NESHAP AFFECTED SOURCES

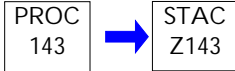
**I. RESTRICTIONS.**

No additional requirements exist except as provided in other sections of this permit including Section B (Title V General Requirements) and/or Section E (Source Group Restrictions).

II. TESTING REQUIREMENTS.

No additional testing requirements exist except as provided in other sections of this permit including Section B (Title V General Requirements) and/or Section E (Source Group Restrictions).

III. MONITORING REQUIREMENTS.

No additional monitoring requirements exist except as provided in other sections of this permit including Section B (Title V General Requirements) and/or Section E (Source Group Restrictions).

IV. RECORDKEEPING REQUIREMENTS.

No additional record keeping requirements exist except as provided in other sections of this permit including Section B (Title V General Requirements) and/or Section E (Source Group Restrictions).

V. REPORTING REQUIREMENTS.

No additional reporting requirements exist except as provided in other sections of this permit including Section B (Title V General Requirements) and/or Section E (Source Group Restrictions).

VI. WORK PRACTICE REQUIREMENTS.

No additional work practice requirements exist except as provided in other sections of this permit including Section B (Title V General Requirements) and/or Section E (Source Group Restrictions).

VII. ADDITIONAL REQUIREMENTS.

No additional requirements exist except as provided in other sections of this permit including Section B (Title V General Requirements) and/or Section E (Source Group Restrictions).

*** Permit Shield in Effect. ***

**SECTION D. Source Level Requirements**

Source ID: 144

Source Name: #12 SILO FEEDER

Source Capacity/Throughput:

13.000 Tons/HR

LIMESTONE

Conditions for this source occur in the following groups: 5 - OTHER NESHP AFFECTED SOURCES

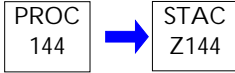
**I. RESTRICTIONS.**

No additional requirements exist except as provided in other sections of this permit including Section B (Title V General Requirements) and/or Section E (Source Group Restrictions).

II. TESTING REQUIREMENTS.

No additional testing requirements exist except as provided in other sections of this permit including Section B (Title V General Requirements) and/or Section E (Source Group Restrictions).

III. MONITORING REQUIREMENTS.

No additional monitoring requirements exist except as provided in other sections of this permit including Section B (Title V General Requirements) and/or Section E (Source Group Restrictions).

IV. RECORDKEEPING REQUIREMENTS.

No additional record keeping requirements exist except as provided in other sections of this permit including Section B (Title V General Requirements) and/or Section E (Source Group Restrictions).

V. REPORTING REQUIREMENTS.

No additional reporting requirements exist except as provided in other sections of this permit including Section B (Title V General Requirements) and/or Section E (Source Group Restrictions).

VI. WORK PRACTICE REQUIREMENTS.

No additional work practice requirements exist except as provided in other sections of this permit including Section B (Title V General Requirements) and/or Section E (Source Group Restrictions).

VII. ADDITIONAL REQUIREMENTS.

No additional requirements exist except as provided in other sections of this permit including Section B (Title V General Requirements) and/or Section E (Source Group Restrictions).

*** Permit Shield in Effect. ***

**SECTION D. Source Level Requirements**

Source ID: 145

Source Name: #11 SILO FEEDER

Source Capacity/Throughput:

13.000 Tons/HR

LIMESTONE

Conditions for this source occur in the following groups: 5 - OTHER NESHAP AFFECTED SOURCES

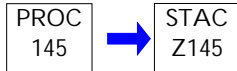
**I. RESTRICTIONS.**

No additional requirements exist except as provided in other sections of this permit including Section B (Title V General Requirements) and/or Section E (Source Group Restrictions).

II. TESTING REQUIREMENTS.

No additional testing requirements exist except as provided in other sections of this permit including Section B (Title V General Requirements) and/or Section E (Source Group Restrictions).

III. MONITORING REQUIREMENTS.

No additional monitoring requirements exist except as provided in other sections of this permit including Section B (Title V General Requirements) and/or Section E (Source Group Restrictions).

IV. RECORDKEEPING REQUIREMENTS.

No additional record keeping requirements exist except as provided in other sections of this permit including Section B (Title V General Requirements) and/or Section E (Source Group Restrictions).

V. REPORTING REQUIREMENTS.

No additional reporting requirements exist except as provided in other sections of this permit including Section B (Title V General Requirements) and/or Section E (Source Group Restrictions).

VI. WORK PRACTICE REQUIREMENTS.

No additional work practice requirements exist except as provided in other sections of this permit including Section B (Title V General Requirements) and/or Section E (Source Group Restrictions).

VII. ADDITIONAL REQUIREMENTS.

No additional requirements exist except as provided in other sections of this permit including Section B (Title V General Requirements) and/or Section E (Source Group Restrictions).

*** Permit Shield in Effect. ***

**SECTION D. Source Level Requirements**

Source ID: 146

Source Name: #10 SILO FEEDER

Source Capacity/Throughput:

13.000 Tons/HR

LIMESTONE

Conditions for this source occur in the following groups: 5 - OTHER NESHAP AFFECTED SOURCES

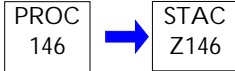
**I. RESTRICTIONS.**

No additional requirements exist except as provided in other sections of this permit including Section B (Title V General Requirements) and/or Section E (Source Group Restrictions).

II. TESTING REQUIREMENTS.

No additional testing requirements exist except as provided in other sections of this permit including Section B (Title V General Requirements) and/or Section E (Source Group Restrictions).

III. MONITORING REQUIREMENTS.

No additional monitoring requirements exist except as provided in other sections of this permit including Section B (Title V General Requirements) and/or Section E (Source Group Restrictions).

IV. RECORDKEEPING REQUIREMENTS.

No additional record keeping requirements exist except as provided in other sections of this permit including Section B (Title V General Requirements) and/or Section E (Source Group Restrictions).

V. REPORTING REQUIREMENTS.

No additional reporting requirements exist except as provided in other sections of this permit including Section B (Title V General Requirements) and/or Section E (Source Group Restrictions).

VI. WORK PRACTICE REQUIREMENTS.

No additional work practice requirements exist except as provided in other sections of this permit including Section B (Title V General Requirements) and/or Section E (Source Group Restrictions).

VII. ADDITIONAL REQUIREMENTS.

No additional requirements exist except as provided in other sections of this permit including Section B (Title V General Requirements) and/or Section E (Source Group Restrictions).

*** Permit Shield in Effect. ***

**SECTION D. Source Level Requirements**

Source ID: 147

Source Name: CLINKER SILO FEEDER

Source Capacity/Throughput: 32.000 Tons/HR CLINKER

Conditions for this source occur in the following groups: 5 - OTHER NESHAP AFFECTED SOURCES

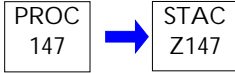
**I. RESTRICTIONS.**

No additional requirements exist except as provided in other sections of this permit including Section B (Title V General Requirements) and/or Section E (Source Group Restrictions).

II. TESTING REQUIREMENTS.

No additional testing requirements exist except as provided in other sections of this permit including Section B (Title V General Requirements) and/or Section E (Source Group Restrictions).

III. MONITORING REQUIREMENTS.

No additional monitoring requirements exist except as provided in other sections of this permit including Section B (Title V General Requirements) and/or Section E (Source Group Restrictions).

IV. RECORDKEEPING REQUIREMENTS.

No additional record keeping requirements exist except as provided in other sections of this permit including Section B (Title V General Requirements) and/or Section E (Source Group Restrictions).

V. REPORTING REQUIREMENTS.

No additional reporting requirements exist except as provided in other sections of this permit including Section B (Title V General Requirements) and/or Section E (Source Group Restrictions).

VI. WORK PRACTICE REQUIREMENTS.

No additional work practice requirements exist except as provided in other sections of this permit including Section B (Title V General Requirements) and/or Section E (Source Group Restrictions).

VII. ADDITIONAL REQUIREMENTS.

No additional requirements exist except as provided in other sections of this permit including Section B (Title V General Requirements) and/or Section E (Source Group Restrictions).

*** Permit Shield in Effect. ***

**SECTION D. Source Level Requirements**

Source ID: 148

Source Name: #9 SILO #1 FEEDER

Source Capacity/Throughput: 0.800 Tons/HR SAND/GRAVEL

Conditions for this source occur in the following groups: 5 - OTHER NESHAP AFFECTED SOURCES

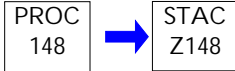
**I. RESTRICTIONS.**

No additional requirements exist except as provided in other sections of this permit including Section B (Title V General Requirements) and/or Section E (Source Group Restrictions).

II. TESTING REQUIREMENTS.

No additional testing requirements exist except as provided in other sections of this permit including Section B (Title V General Requirements) and/or Section E (Source Group Restrictions).

III. MONITORING REQUIREMENTS.

No additional monitoring requirements exist except as provided in other sections of this permit including Section B (Title V General Requirements) and/or Section E (Source Group Restrictions).

IV. RECORDKEEPING REQUIREMENTS.

No additional record keeping requirements exist except as provided in other sections of this permit including Section B (Title V General Requirements) and/or Section E (Source Group Restrictions).

V. REPORTING REQUIREMENTS.

No additional reporting requirements exist except as provided in other sections of this permit including Section B (Title V General Requirements) and/or Section E (Source Group Restrictions).

VI. WORK PRACTICE REQUIREMENTS.

No additional work practice requirements exist except as provided in other sections of this permit including Section B (Title V General Requirements) and/or Section E (Source Group Restrictions).

VII. ADDITIONAL REQUIREMENTS.

No additional requirements exist except as provided in other sections of this permit including Section B (Title V General Requirements) and/or Section E (Source Group Restrictions).

*** Permit Shield in Effect. ***

**SECTION D. Source Level Requirements**

Source ID: 149

Source Name: #9 SILO #2 FEEDER

Source Capacity/Throughput: 0.800 Tons/HR SAND/GRAVEL

Conditions for this source occur in the following groups: 5 - OTHER NESHAP AFFECTED SOURCES

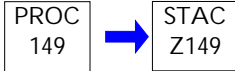
**I. RESTRICTIONS.**

No additional requirements exist except as provided in other sections of this permit including Section B (Title V General Requirements) and/or Section E (Source Group Restrictions).

II. TESTING REQUIREMENTS.

No additional testing requirements exist except as provided in other sections of this permit including Section B (Title V General Requirements) and/or Section E (Source Group Restrictions).

III. MONITORING REQUIREMENTS.

No additional monitoring requirements exist except as provided in other sections of this permit including Section B (Title V General Requirements) and/or Section E (Source Group Restrictions).

IV. RECORDKEEPING REQUIREMENTS.

No additional record keeping requirements exist except as provided in other sections of this permit including Section B (Title V General Requirements) and/or Section E (Source Group Restrictions).

V. REPORTING REQUIREMENTS.

No additional reporting requirements exist except as provided in other sections of this permit including Section B (Title V General Requirements) and/or Section E (Source Group Restrictions).

VI. WORK PRACTICE REQUIREMENTS.

No additional work practice requirements exist except as provided in other sections of this permit including Section B (Title V General Requirements) and/or Section E (Source Group Restrictions).

VII. ADDITIONAL REQUIREMENTS.

No additional requirements exist except as provided in other sections of this permit including Section B (Title V General Requirements) and/or Section E (Source Group Restrictions).

*** Permit Shield in Effect. ***

**SECTION D. Source Level Requirements**

Source ID: 150

Source Name: #7 BELT TO CLINKER SILO TRANSFER

Source Capacity/Throughput: 9.000 Tons/HR CLINKER

Conditions for this source occur in the following groups: 1B - SOURCES WITH NEW BAGHOUSES
5 - OTHER NESHAP AFFECTED SOURCES

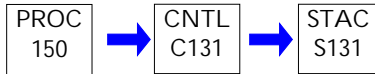
**I. RESTRICTIONS.**

No additional requirements exist except as provided in other sections of this permit including Section B (Title V General Requirements) and/or Section E (Source Group Restrictions).

II. TESTING REQUIREMENTS.

No additional testing requirements exist except as provided in other sections of this permit including Section B (Title V General Requirements) and/or Section E (Source Group Restrictions).

III. MONITORING REQUIREMENTS.

No additional monitoring requirements exist except as provided in other sections of this permit including Section B (Title V General Requirements) and/or Section E (Source Group Restrictions).

IV. RECORDKEEPING REQUIREMENTS.

No additional record keeping requirements exist except as provided in other sections of this permit including Section B (Title V General Requirements) and/or Section E (Source Group Restrictions).

V. REPORTING REQUIREMENTS.

No additional reporting requirements exist except as provided in other sections of this permit including Section B (Title V General Requirements) and/or Section E (Source Group Restrictions).

VI. WORK PRACTICE REQUIREMENTS.

No additional work practice requirements exist except as provided in other sections of this permit including Section B (Title V General Requirements) and/or Section E (Source Group Restrictions).

VII. ADDITIONAL REQUIREMENTS.

No additional requirements exist except as provided in other sections of this permit including Section B (Title V General Requirements) and/or Section E (Source Group Restrictions).

*** Permit Shield in Effect. ***

**SECTION D. Source Level Requirements**

Source ID: 151

Source Name: #5 SILO FEEDER

Source Capacity/Throughput:

6.000 Tons/HR

LIMESTONE

Conditions for this source occur in the following groups: 5 - OTHER NESHAP AFFECTED SOURCES

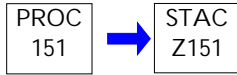
**I. RESTRICTIONS.**

No additional requirements exist except as provided in other sections of this permit including Section B (Title V General Requirements) and/or Section E (Source Group Restrictions).

II. TESTING REQUIREMENTS.

No additional testing requirements exist except as provided in other sections of this permit including Section B (Title V General Requirements) and/or Section E (Source Group Restrictions).

III. MONITORING REQUIREMENTS.

No additional monitoring requirements exist except as provided in other sections of this permit including Section B (Title V General Requirements) and/or Section E (Source Group Restrictions).

IV. RECORDKEEPING REQUIREMENTS.

No additional record keeping requirements exist except as provided in other sections of this permit including Section B (Title V General Requirements) and/or Section E (Source Group Restrictions).

V. REPORTING REQUIREMENTS.

No additional reporting requirements exist except as provided in other sections of this permit including Section B (Title V General Requirements) and/or Section E (Source Group Restrictions).

VI. WORK PRACTICE REQUIREMENTS.

No additional work practice requirements exist except as provided in other sections of this permit including Section B (Title V General Requirements) and/or Section E (Source Group Restrictions).

VII. ADDITIONAL REQUIREMENTS.

No additional requirements exist except as provided in other sections of this permit including Section B (Title V General Requirements) and/or Section E (Source Group Restrictions).

*** Permit Shield in Effect. ***

**SECTION D. Source Level Requirements**

Source ID: 152

Source Name: #1 SHALE FEEDER

Source Capacity/Throughput: 5.000 Tons/HR SHALE

Conditions for this source occur in the following groups: 5 - OTHER NESHAP AFFECTED SOURCES

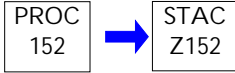
**I. RESTRICTIONS.**

No additional requirements exist except as provided in other sections of this permit including Section B (Title V General Requirements) and/or Section E (Source Group Restrictions).

II. TESTING REQUIREMENTS.

No additional testing requirements exist except as provided in other sections of this permit including Section B (Title V General Requirements) and/or Section E (Source Group Restrictions).

III. MONITORING REQUIREMENTS.

No additional monitoring requirements exist except as provided in other sections of this permit including Section B (Title V General Requirements) and/or Section E (Source Group Restrictions).

IV. RECORDKEEPING REQUIREMENTS.

No additional record keeping requirements exist except as provided in other sections of this permit including Section B (Title V General Requirements) and/or Section E (Source Group Restrictions).

V. REPORTING REQUIREMENTS.

No additional reporting requirements exist except as provided in other sections of this permit including Section B (Title V General Requirements) and/or Section E (Source Group Restrictions).

VI. WORK PRACTICE REQUIREMENTS.

No additional work practice requirements exist except as provided in other sections of this permit including Section B (Title V General Requirements) and/or Section E (Source Group Restrictions).

VII. ADDITIONAL REQUIREMENTS.

No additional requirements exist except as provided in other sections of this permit including Section B (Title V General Requirements) and/or Section E (Source Group Restrictions).

*** Permit Shield in Effect. ***

SECTION D. Source Level Requirements

Source ID: 153

Source Name: #2 SHALE FEEDER

Source Capacity/Throughput: 5.000 Tons/HR SHALE

Conditions for this source occur in the following groups: 5 - OTHER NESHAP AFFECTED SOURCES

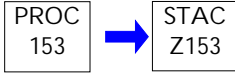
**I. RESTRICTIONS.**

No additional requirements exist except as provided in other sections of this permit including Section B (Title V General Requirements) and/or Section E (Source Group Restrictions).

II. TESTING REQUIREMENTS.

No additional testing requirements exist except as provided in other sections of this permit including Section B (Title V General Requirements) and/or Section E (Source Group Restrictions).

III. MONITORING REQUIREMENTS.

No additional monitoring requirements exist except as provided in other sections of this permit including Section B (Title V General Requirements) and/or Section E (Source Group Restrictions).

IV. RECORDKEEPING REQUIREMENTS.

No additional record keeping requirements exist except as provided in other sections of this permit including Section B (Title V General Requirements) and/or Section E (Source Group Restrictions).

V. REPORTING REQUIREMENTS.

No additional reporting requirements exist except as provided in other sections of this permit including Section B (Title V General Requirements) and/or Section E (Source Group Restrictions).

VI. WORK PRACTICE REQUIREMENTS.

No additional work practice requirements exist except as provided in other sections of this permit including Section B (Title V General Requirements) and/or Section E (Source Group Restrictions).

VII. ADDITIONAL REQUIREMENTS.

No additional requirements exist except as provided in other sections of this permit including Section B (Title V General Requirements) and/or Section E (Source Group Restrictions).

*** Permit Shield in Effect. ***

**SECTION D. Source Level Requirements**

Source ID: 154

Source Name: #3 SHALE FEEDER

Source Capacity/Throughput: 5.000 Tons/HR SHALE

Conditions for this source occur in the following groups: 5 - OTHER NESHAP AFFECTED SOURCES

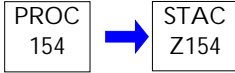
**I. RESTRICTIONS.**

No additional requirements exist except as provided in other sections of this permit including Section B (Title V General Requirements) and/or Section E (Source Group Restrictions).

II. TESTING REQUIREMENTS.

No additional testing requirements exist except as provided in other sections of this permit including Section B (Title V General Requirements) and/or Section E (Source Group Restrictions).

III. MONITORING REQUIREMENTS.

No additional monitoring requirements exist except as provided in other sections of this permit including Section B (Title V General Requirements) and/or Section E (Source Group Restrictions).

IV. RECORDKEEPING REQUIREMENTS.

No additional record keeping requirements exist except as provided in other sections of this permit including Section B (Title V General Requirements) and/or Section E (Source Group Restrictions).

V. REPORTING REQUIREMENTS.

No additional reporting requirements exist except as provided in other sections of this permit including Section B (Title V General Requirements) and/or Section E (Source Group Restrictions).

VI. WORK PRACTICE REQUIREMENTS.

No additional work practice requirements exist except as provided in other sections of this permit including Section B (Title V General Requirements) and/or Section E (Source Group Restrictions).

VII. ADDITIONAL REQUIREMENTS.

No additional requirements exist except as provided in other sections of this permit including Section B (Title V General Requirements) and/or Section E (Source Group Restrictions).

*** Permit Shield in Effect. ***

**SECTION D. Source Level Requirements**

Source ID: 155

Source Name: #1 RAW MILL FEED BELT

Source Capacity/Throughput: 45.000 Tons/HR LIMESTONE, SHALE

Conditions for this source occur in the following groups: 5 - OTHER NESHAP AFFECTED SOURCES

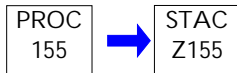
**I. RESTRICTIONS.**

No additional requirements exist except as provided in other sections of this permit including Section B (Title V General Requirements) and/or Section E (Source Group Restrictions).

II. TESTING REQUIREMENTS.

No additional testing requirements exist except as provided in other sections of this permit including Section B (Title V General Requirements) and/or Section E (Source Group Restrictions).

III. MONITORING REQUIREMENTS.

No additional monitoring requirements exist except as provided in other sections of this permit including Section B (Title V General Requirements) and/or Section E (Source Group Restrictions).

IV. RECORDKEEPING REQUIREMENTS.

No additional record keeping requirements exist except as provided in other sections of this permit including Section B (Title V General Requirements) and/or Section E (Source Group Restrictions).

V. REPORTING REQUIREMENTS.

No additional reporting requirements exist except as provided in other sections of this permit including Section B (Title V General Requirements) and/or Section E (Source Group Restrictions).

VI. WORK PRACTICE REQUIREMENTS.

No additional work practice requirements exist except as provided in other sections of this permit including Section B (Title V General Requirements) and/or Section E (Source Group Restrictions).

VII. ADDITIONAL REQUIREMENTS.

No additional requirements exist except as provided in other sections of this permit including Section B (Title V General Requirements) and/or Section E (Source Group Restrictions).

*** Permit Shield in Effect. ***

**SECTION D. Source Level Requirements**

Source ID: 156

Source Name: #2 SHALE BELT TO #2 RAW MILL FEED BELT

Source Capacity/Throughput: 5.000 Tons/HR SHALE

Conditions for this source occur in the following groups: 5 - OTHER NESHAP AFFECTED SOURCES

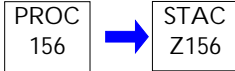
**I. RESTRICTIONS.**

No additional requirements exist except as provided in other sections of this permit including Section B (Title V General Requirements) and/or Section E (Source Group Restrictions).

II. TESTING REQUIREMENTS.

No additional testing requirements exist except as provided in other sections of this permit including Section B (Title V General Requirements) and/or Section E (Source Group Restrictions).

III. MONITORING REQUIREMENTS.

No additional monitoring requirements exist except as provided in other sections of this permit including Section B (Title V General Requirements) and/or Section E (Source Group Restrictions).

IV. RECORDKEEPING REQUIREMENTS.

No additional record keeping requirements exist except as provided in other sections of this permit including Section B (Title V General Requirements) and/or Section E (Source Group Restrictions).

V. REPORTING REQUIREMENTS.

No additional reporting requirements exist except as provided in other sections of this permit including Section B (Title V General Requirements) and/or Section E (Source Group Restrictions).

VI. WORK PRACTICE REQUIREMENTS.

No additional work practice requirements exist except as provided in other sections of this permit including Section B (Title V General Requirements) and/or Section E (Source Group Restrictions).

VII. ADDITIONAL REQUIREMENTS.

No additional requirements exist except as provided in other sections of this permit including Section B (Title V General Requirements) and/or Section E (Source Group Restrictions).

*** Permit Shield in Effect. ***

**SECTION D. Source Level Requirements**

Source ID: 157

Source Name: #2 RAW MILL FEED BELT

Source Capacity/Throughput: 45.000 Tons/HR LIMESTONE, SHALE

Conditions for this source occur in the following groups: 5 - OTHER NESHP AFFECTED SOURCES

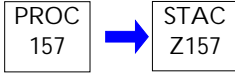
**I. RESTRICTIONS.**

No additional requirements exist except as provided in other sections of this permit including Section B (Title V General Requirements) and/or Section E (Source Group Restrictions).

II. TESTING REQUIREMENTS.

No additional testing requirements exist except as provided in other sections of this permit including Section B (Title V General Requirements) and/or Section E (Source Group Restrictions).

III. MONITORING REQUIREMENTS.

No additional monitoring requirements exist except as provided in other sections of this permit including Section B (Title V General Requirements) and/or Section E (Source Group Restrictions).

IV. RECORDKEEPING REQUIREMENTS.

No additional record keeping requirements exist except as provided in other sections of this permit including Section B (Title V General Requirements) and/or Section E (Source Group Restrictions).

V. REPORTING REQUIREMENTS.

No additional reporting requirements exist except as provided in other sections of this permit including Section B (Title V General Requirements) and/or Section E (Source Group Restrictions).

VI. WORK PRACTICE REQUIREMENTS.

No additional work practice requirements exist except as provided in other sections of this permit including Section B (Title V General Requirements) and/or Section E (Source Group Restrictions).

VII. ADDITIONAL REQUIREMENTS.

No additional requirements exist except as provided in other sections of this permit including Section B (Title V General Requirements) and/or Section E (Source Group Restrictions).

*** Permit Shield in Effect. ***

**SECTION D. Source Level Requirements**

Source ID: 158

Source Name: #3 SHALE BELT TO #3 RAW MILL FEED BELT

Source Capacity/Throughput: 5.000 Tons/HR SHALE

Conditions for this source occur in the following groups: 5 - OTHER NESHAPE AFFECTED SOURCES

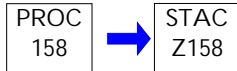
**I. RESTRICTIONS.**

No additional requirements exist except as provided in other sections of this permit including Section B (Title V General Requirements) and/or Section E (Source Group Restrictions).

II. TESTING REQUIREMENTS.

No additional testing requirements exist except as provided in other sections of this permit including Section B (Title V General Requirements) and/or Section E (Source Group Restrictions).

III. MONITORING REQUIREMENTS.

No additional monitoring requirements exist except as provided in other sections of this permit including Section B (Title V General Requirements) and/or Section E (Source Group Restrictions).

IV. RECORDKEEPING REQUIREMENTS.

No additional record keeping requirements exist except as provided in other sections of this permit including Section B (Title V General Requirements) and/or Section E (Source Group Restrictions).

V. REPORTING REQUIREMENTS.

No additional reporting requirements exist except as provided in other sections of this permit including Section B (Title V General Requirements) and/or Section E (Source Group Restrictions).

VI. WORK PRACTICE REQUIREMENTS.

No additional work practice requirements exist except as provided in other sections of this permit including Section B (Title V General Requirements) and/or Section E (Source Group Restrictions).

VII. ADDITIONAL REQUIREMENTS.

No additional requirements exist except as provided in other sections of this permit including Section B (Title V General Requirements) and/or Section E (Source Group Restrictions).

*** Permit Shield in Effect. ***

**SECTION D. Source Level Requirements**

Source ID: 159

Source Name: #3 RAW MILL FEED BELT

Source Capacity/Throughput: 56.000 Tons/HR LIMESTONE/SHALE

Conditions for this source occur in the following groups: 5 - OTHER NESHP AFFECTED SOURCES

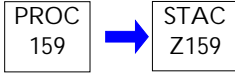
**I. RESTRICTIONS.**

No additional requirements exist except as provided in other sections of this permit including Section B (Title V General Requirements) and/or Section E (Source Group Restrictions).

II. TESTING REQUIREMENTS.

No additional testing requirements exist except as provided in other sections of this permit including Section B (Title V General Requirements) and/or Section E (Source Group Restrictions).

III. MONITORING REQUIREMENTS.

No additional monitoring requirements exist except as provided in other sections of this permit including Section B (Title V General Requirements) and/or Section E (Source Group Restrictions).

IV. RECORDKEEPING REQUIREMENTS.

No additional record keeping requirements exist except as provided in other sections of this permit including Section B (Title V General Requirements) and/or Section E (Source Group Restrictions).

V. REPORTING REQUIREMENTS.

No additional reporting requirements exist except as provided in other sections of this permit including Section B (Title V General Requirements) and/or Section E (Source Group Restrictions).

VI. WORK PRACTICE REQUIREMENTS.

No additional work practice requirements exist except as provided in other sections of this permit including Section B (Title V General Requirements) and/or Section E (Source Group Restrictions).

VII. ADDITIONAL REQUIREMENTS.

No additional requirements exist except as provided in other sections of this permit including Section B (Title V General Requirements) and/or Section E (Source Group Restrictions).

*** Permit Shield in Effect. ***

**SECTION D. Source Level Requirements**

Source ID: 160

Source Name: #1 FINISH MILL FEED ELEVATOR

Source Capacity/Throughput: 12.000 Tons/HR CLINKER

Conditions for this source occur in the following groups: 5 - OTHER NESHAP AFFECTED SOURCES

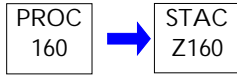
**I. RESTRICTIONS.**

No additional requirements exist except as provided in other sections of this permit including Section B (Title V General Requirements) and/or Section E (Source Group Restrictions).

II. TESTING REQUIREMENTS.

No additional testing requirements exist except as provided in other sections of this permit including Section B (Title V General Requirements) and/or Section E (Source Group Restrictions).

III. MONITORING REQUIREMENTS.

No additional monitoring requirements exist except as provided in other sections of this permit including Section B (Title V General Requirements) and/or Section E (Source Group Restrictions).

IV. RECORDKEEPING REQUIREMENTS.

No additional record keeping requirements exist except as provided in other sections of this permit including Section B (Title V General Requirements) and/or Section E (Source Group Restrictions).

V. REPORTING REQUIREMENTS.

No additional reporting requirements exist except as provided in other sections of this permit including Section B (Title V General Requirements) and/or Section E (Source Group Restrictions).

VI. WORK PRACTICE REQUIREMENTS.

No additional work practice requirements exist except as provided in other sections of this permit including Section B (Title V General Requirements) and/or Section E (Source Group Restrictions).

VII. ADDITIONAL REQUIREMENTS.

No additional requirements exist except as provided in other sections of this permit including Section B (Title V General Requirements) and/or Section E (Source Group Restrictions).

*** Permit Shield in Effect. ***

**SECTION D. Source Level Requirements**

Source ID: 161

Source Name: TURNHEAD TO #5 COAL BELT TRANSFER

Source Capacity/Throughput: 70.000 Tons/HR COAL

Conditions for this source occur in the following groups: 5 - OTHER NESHAP AFFECTED SOURCES

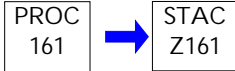
**I. RESTRICTIONS.**

No additional requirements exist except as provided in other sections of this permit including Section B (Title V General Requirements) and/or Section E (Source Group Restrictions).

II. TESTING REQUIREMENTS.

No additional testing requirements exist except as provided in other sections of this permit including Section B (Title V General Requirements) and/or Section E (Source Group Restrictions).

III. MONITORING REQUIREMENTS.

No additional monitoring requirements exist except as provided in other sections of this permit including Section B (Title V General Requirements) and/or Section E (Source Group Restrictions).

IV. RECORDKEEPING REQUIREMENTS.

No additional record keeping requirements exist except as provided in other sections of this permit including Section B (Title V General Requirements) and/or Section E (Source Group Restrictions).

V. REPORTING REQUIREMENTS.

No additional reporting requirements exist except as provided in other sections of this permit including Section B (Title V General Requirements) and/or Section E (Source Group Restrictions).

VI. WORK PRACTICE REQUIREMENTS.

No additional work practice requirements exist except as provided in other sections of this permit including Section B (Title V General Requirements) and/or Section E (Source Group Restrictions).

VII. ADDITIONAL REQUIREMENTS.

No additional requirements exist except as provided in other sections of this permit including Section B (Title V General Requirements) and/or Section E (Source Group Restrictions).

*** Permit Shield in Effect. ***

**SECTION D. Source Level Requirements**

Source ID: 162

Source Name: DIVERTER BOX TO #2 COAL TANK TRANSFER

Source Capacity/Throughput: 24.000 Tons/HR COAL

Conditions for this source occur in the following groups: 5 - OTHER NESHAP AFFECTED SOURCES

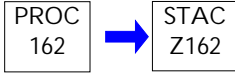
**I. RESTRICTIONS.**

No additional requirements exist except as provided in other sections of this permit including Section B (Title V General Requirements) and/or Section E (Source Group Restrictions).

II. TESTING REQUIREMENTS.

No additional testing requirements exist except as provided in other sections of this permit including Section B (Title V General Requirements) and/or Section E (Source Group Restrictions).

III. MONITORING REQUIREMENTS.

No additional monitoring requirements exist except as provided in other sections of this permit including Section B (Title V General Requirements) and/or Section E (Source Group Restrictions).

IV. RECORDKEEPING REQUIREMENTS.

No additional record keeping requirements exist except as provided in other sections of this permit including Section B (Title V General Requirements) and/or Section E (Source Group Restrictions).

V. REPORTING REQUIREMENTS.

No additional reporting requirements exist except as provided in other sections of this permit including Section B (Title V General Requirements) and/or Section E (Source Group Restrictions).

VI. WORK PRACTICE REQUIREMENTS.

No additional work practice requirements exist except as provided in other sections of this permit including Section B (Title V General Requirements) and/or Section E (Source Group Restrictions).

VII. ADDITIONAL REQUIREMENTS.

No additional requirements exist except as provided in other sections of this permit including Section B (Title V General Requirements) and/or Section E (Source Group Restrictions).

*** Permit Shield in Effect. ***

SECTION D. Source Level Requirements

Source ID: 163

Source Name: DIVERTER BOX TO COAL BELT TRANSFER

Source Capacity/Throughput: 50.000 Tons/HR COAL

Conditions for this source occur in the following groups: 5 - OTHER NESHAP AFFECTED SOURCES

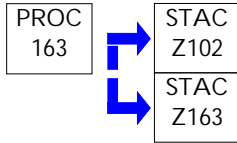
**I. RESTRICTIONS.**

No additional requirements exist except as provided in other sections of this permit including Section B (Title V General Requirements) and/or Section E (Source Group Restrictions).

II. TESTING REQUIREMENTS.

No additional testing requirements exist except as provided in other sections of this permit including Section B (Title V General Requirements) and/or Section E (Source Group Restrictions).

III. MONITORING REQUIREMENTS.

No additional monitoring requirements exist except as provided in other sections of this permit including Section B (Title V General Requirements) and/or Section E (Source Group Restrictions).

IV. RECORDKEEPING REQUIREMENTS.

No additional record keeping requirements exist except as provided in other sections of this permit including Section B (Title V General Requirements) and/or Section E (Source Group Restrictions).

V. REPORTING REQUIREMENTS.

No additional reporting requirements exist except as provided in other sections of this permit including Section B (Title V General Requirements) and/or Section E (Source Group Restrictions).

VI. WORK PRACTICE REQUIREMENTS.

No additional work practice requirements exist except as provided in other sections of this permit including Section B (Title V General Requirements) and/or Section E (Source Group Restrictions).

VII. ADDITIONAL REQUIREMENTS.

No additional requirements exist except as provided in other sections of this permit including Section B (Title V General Requirements) and/or Section E (Source Group Restrictions).

*** Permit Shield in Effect. ***

SECTION D. Source Level Requirements

Source ID: 164

Source Name: COAL BELT TO #1 COAL TANK TRANSFER

Source Capacity/Throughput: 24.000 Tons/HR COAL

Conditions for this source occur in the following groups: 5 - OTHER NESHAP AFFECTED SOURCES

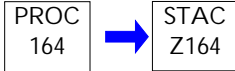
**I. RESTRICTIONS.**

No additional requirements exist except as provided in other sections of this permit including Section B (Title V General Requirements) and/or Section E (Source Group Restrictions).

II. TESTING REQUIREMENTS.

No additional testing requirements exist except as provided in other sections of this permit including Section B (Title V General Requirements) and/or Section E (Source Group Restrictions).

III. MONITORING REQUIREMENTS.

No additional monitoring requirements exist except as provided in other sections of this permit including Section B (Title V General Requirements) and/or Section E (Source Group Restrictions).

IV. RECORDKEEPING REQUIREMENTS.

No additional record keeping requirements exist except as provided in other sections of this permit including Section B (Title V General Requirements) and/or Section E (Source Group Restrictions).

V. REPORTING REQUIREMENTS.

No additional reporting requirements exist except as provided in other sections of this permit including Section B (Title V General Requirements) and/or Section E (Source Group Restrictions).

VI. WORK PRACTICE REQUIREMENTS.

No additional work practice requirements exist except as provided in other sections of this permit including Section B (Title V General Requirements) and/or Section E (Source Group Restrictions).

VII. ADDITIONAL REQUIREMENTS.

No additional requirements exist except as provided in other sections of this permit including Section B (Title V General Requirements) and/or Section E (Source Group Restrictions).

*** Permit Shield in Effect. ***

**SECTION D. Source Level Requirements**

Source ID: 165

Source Name: COAL BELT TO #3 COAL TANK TRANSFER

Source Capacity/Throughput: 24.000 Tons/HR COAL

Conditions for this source occur in the following groups: 5 - OTHER NESHAP AFFECTED SOURCES

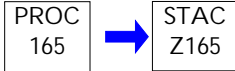
**I. RESTRICTIONS.**

No additional requirements exist except as provided in other sections of this permit including Section B (Title V General Requirements) and/or Section E (Source Group Restrictions).

II. TESTING REQUIREMENTS.

No additional testing requirements exist except as provided in other sections of this permit including Section B (Title V General Requirements) and/or Section E (Source Group Restrictions).

III. MONITORING REQUIREMENTS.

No additional monitoring requirements exist except as provided in other sections of this permit including Section B (Title V General Requirements) and/or Section E (Source Group Restrictions).

IV. RECORDKEEPING REQUIREMENTS.

No additional record keeping requirements exist except as provided in other sections of this permit including Section B (Title V General Requirements) and/or Section E (Source Group Restrictions).

V. REPORTING REQUIREMENTS.

No additional reporting requirements exist except as provided in other sections of this permit including Section B (Title V General Requirements) and/or Section E (Source Group Restrictions).

VI. WORK PRACTICE REQUIREMENTS.

No additional work practice requirements exist except as provided in other sections of this permit including Section B (Title V General Requirements) and/or Section E (Source Group Restrictions).

VII. ADDITIONAL REQUIREMENTS.

No additional requirements exist except as provided in other sections of this permit including Section B (Title V General Requirements) and/or Section E (Source Group Restrictions).

*** Permit Shield in Effect. ***

**SECTION D. Source Level Requirements**

Source ID: 166

Source Name: TURNHEAD TO GYPSUM BELT TRANSFER

Source Capacity/Throughput: 5.000 Tons/HR GYPSUM

Conditions for this source occur in the following groups: 5 - OTHER NESHAP AFFECTED SOURCES

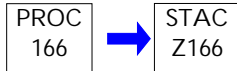
**I. RESTRICTIONS.**

No additional requirements exist except as provided in other sections of this permit including Section B (Title V General Requirements) and/or Section E (Source Group Restrictions).

II. TESTING REQUIREMENTS.

No additional testing requirements exist except as provided in other sections of this permit including Section B (Title V General Requirements) and/or Section E (Source Group Restrictions).

III. MONITORING REQUIREMENTS.

No additional monitoring requirements exist except as provided in other sections of this permit including Section B (Title V General Requirements) and/or Section E (Source Group Restrictions).

IV. RECORDKEEPING REQUIREMENTS.

No additional record keeping requirements exist except as provided in other sections of this permit including Section B (Title V General Requirements) and/or Section E (Source Group Restrictions).

V. REPORTING REQUIREMENTS.

No additional reporting requirements exist except as provided in other sections of this permit including Section B (Title V General Requirements) and/or Section E (Source Group Restrictions).

VI. WORK PRACTICE REQUIREMENTS.

No additional work practice requirements exist except as provided in other sections of this permit including Section B (Title V General Requirements) and/or Section E (Source Group Restrictions).

VII. ADDITIONAL REQUIREMENTS.

No additional requirements exist except as provided in other sections of this permit including Section B (Title V General Requirements) and/or Section E (Source Group Restrictions).

*** Permit Shield in Effect. ***

**SECTION D. Source Level Requirements**

Source ID: 167

Source Name: KILN DUST (EARTH PLUS) LOADING

Source Capacity/Throughput:

1.000 Tons/HR

EARTH PLUS

Conditions for this source occur in the following groups: 5 - OTHER NESHAPE AFFECTED SOURCES

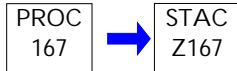
**I. RESTRICTIONS.**

No additional requirements exist except as provided in other sections of this permit including Section B (Title V General Requirements) and/or Section E (Source Group Restrictions).

II. TESTING REQUIREMENTS.

No additional testing requirements exist except as provided in other sections of this permit including Section B (Title V General Requirements) and/or Section E (Source Group Restrictions).

III. MONITORING REQUIREMENTS.

No additional monitoring requirements exist except as provided in other sections of this permit including Section B (Title V General Requirements) and/or Section E (Source Group Restrictions).

IV. RECORDKEEPING REQUIREMENTS.

No additional record keeping requirements exist except as provided in other sections of this permit including Section B (Title V General Requirements) and/or Section E (Source Group Restrictions).

V. REPORTING REQUIREMENTS.

No additional reporting requirements exist except as provided in other sections of this permit including Section B (Title V General Requirements) and/or Section E (Source Group Restrictions).

VI. WORK PRACTICE REQUIREMENTS.

No additional work practice requirements exist except as provided in other sections of this permit including Section B (Title V General Requirements) and/or Section E (Source Group Restrictions).

VII. ADDITIONAL REQUIREMENTS.

No additional requirements exist except as provided in other sections of this permit including Section B (Title V General Requirements) and/or Section E (Source Group Restrictions).

*** Permit Shield in Effect. ***

SECTION D. Source Level Requirements

Source ID: 168

Source Name: 3101 BELT TO CLINKER PILE TRANSFER

Source Capacity/Throughput:	88.000 Tons/HR	CLINKER
	1.000 Tons/HR	CLINKER

Conditions for this source occur in the following groups: 1C - CLINKER TRANSFER SYSTEM B.H. (NEW)
5 - OTHER NESHAP AFFECTED SOURCES

**I. RESTRICTIONS.**

No additional requirements exist except as provided in other sections of this permit including Section B (Title V General Requirements) and/or Section E (Source Group Restrictions).

II. TESTING REQUIREMENTS.

No additional testing requirements exist except as provided in other sections of this permit including Section B (Title V General Requirements) and/or Section E (Source Group Restrictions).

III. MONITORING REQUIREMENTS.

No additional monitoring requirements exist except as provided in other sections of this permit including Section B (Title V General Requirements) and/or Section E (Source Group Restrictions).

IV. RECORDKEEPING REQUIREMENTS.

No additional record keeping requirements exist except as provided in other sections of this permit including Section B (Title V General Requirements) and/or Section E (Source Group Restrictions).

V. REPORTING REQUIREMENTS.

No additional reporting requirements exist except as provided in other sections of this permit including Section B (Title V General Requirements) and/or Section E (Source Group Restrictions).

VI. WORK PRACTICE REQUIREMENTS.

No additional work practice requirements exist except as provided in other sections of this permit including Section B (Title V General Requirements) and/or Section E (Source Group Restrictions).

VII. ADDITIONAL REQUIREMENTS.

No additional requirements exist except as provided in other sections of this permit including Section B (Title V General Requirements) and/or Section E (Source Group Restrictions).

*** Permit Shield in Effect. ***

**SECTION D. Source Level Requirements**

Source ID: 169

Source Name: REMOVAL FROM CLINKER PILE

Source Capacity/Throughput: 1.000 Tons/HR CLINKER

Conditions for this source occur in the following groups: 5 - OTHER NESHAP AFFECTED SOURCES

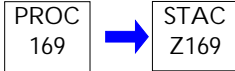
**I. RESTRICTIONS.**

No additional requirements exist except as provided in other sections of this permit including Section B (Title V General Requirements) and/or Section E (Source Group Restrictions).

II. TESTING REQUIREMENTS.

No additional testing requirements exist except as provided in other sections of this permit including Section B (Title V General Requirements) and/or Section E (Source Group Restrictions).

III. MONITORING REQUIREMENTS.

No additional monitoring requirements exist except as provided in other sections of this permit including Section B (Title V General Requirements) and/or Section E (Source Group Restrictions).

IV. RECORDKEEPING REQUIREMENTS.

No additional record keeping requirements exist except as provided in other sections of this permit including Section B (Title V General Requirements) and/or Section E (Source Group Restrictions).

V. REPORTING REQUIREMENTS.

No additional reporting requirements exist except as provided in other sections of this permit including Section B (Title V General Requirements) and/or Section E (Source Group Restrictions).

VI. WORK PRACTICE REQUIREMENTS.

No additional work practice requirements exist except as provided in other sections of this permit including Section B (Title V General Requirements) and/or Section E (Source Group Restrictions).

VII. ADDITIONAL REQUIREMENTS.

No additional requirements exist except as provided in other sections of this permit including Section B (Title V General Requirements) and/or Section E (Source Group Restrictions).

*** Permit Shield in Effect. ***

SECTION D. Source Level Requirements

Source ID: 170

Source Name: GRAVEL BED FILTER DUST TRUCK TRANSFER

Source Capacity/Throughput: 0.020 Tons/HR GBF DUST

Conditions for this source occur in the following groups: 5 - OTHER NESHAP AFFECTED SOURCES

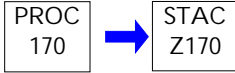

I. RESTRICTIONS.

No additional requirements exist except as provided in other sections of this permit including Section B (Title V General Requirements) and/or Section E (Source Group Restrictions).

II. TESTING REQUIREMENTS.

No additional testing requirements exist except as provided in other sections of this permit including Section B (Title V General Requirements) and/or Section E (Source Group Restrictions).

III. MONITORING REQUIREMENTS.

No additional monitoring requirements exist except as provided in other sections of this permit including Section B (Title V General Requirements) and/or Section E (Source Group Restrictions).

IV. RECORDKEEPING REQUIREMENTS.

No additional record keeping requirements exist except as provided in other sections of this permit including Section B (Title V General Requirements) and/or Section E (Source Group Restrictions).

V. REPORTING REQUIREMENTS.

No additional reporting requirements exist except as provided in other sections of this permit including Section B (Title V General Requirements) and/or Section E (Source Group Restrictions).

VI. WORK PRACTICE REQUIREMENTS.

No additional work practice requirements exist except as provided in other sections of this permit including Section B (Title V General Requirements) and/or Section E (Source Group Restrictions).

VII. ADDITIONAL REQUIREMENTS.

No additional requirements exist except as provided in other sections of this permit including Section B (Title V General Requirements) and/or Section E (Source Group Restrictions).

*** Permit Shield in Effect. ***

SECTION D. Source Level Requirements

Source ID: 171

Source Name: #3 KILN DUST REFEED

Source Capacity/Throughput:

8.000 Tons/HR

ESP DUST

Conditions for this source occur in the following groups: 5 - OTHER NESHAP AFFECTED SOURCES

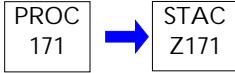

I. RESTRICTIONS.

No additional requirements exist except as provided in other sections of this permit including Section B (Title V General Requirements) and/or Section E (Source Group Restrictions).

II. TESTING REQUIREMENTS.

No additional testing requirements exist except as provided in other sections of this permit including Section B (Title V General Requirements) and/or Section E (Source Group Restrictions).

III. MONITORING REQUIREMENTS.

No additional monitoring requirements exist except as provided in other sections of this permit including Section B (Title V General Requirements) and/or Section E (Source Group Restrictions).

IV. RECORDKEEPING REQUIREMENTS.

No additional record keeping requirements exist except as provided in other sections of this permit including Section B (Title V General Requirements) and/or Section E (Source Group Restrictions).

V. REPORTING REQUIREMENTS.

No additional reporting requirements exist except as provided in other sections of this permit including Section B (Title V General Requirements) and/or Section E (Source Group Restrictions).

VI. WORK PRACTICE REQUIREMENTS.

No additional work practice requirements exist except as provided in other sections of this permit including Section B (Title V General Requirements) and/or Section E (Source Group Restrictions).

VII. ADDITIONAL REQUIREMENTS.

No additional requirements exist except as provided in other sections of this permit including Section B (Title V General Requirements) and/or Section E (Source Group Restrictions).

*** Permit Shield in Effect. ***

**SECTION D. Source Level Requirements**

Source ID: 172

Source Name: #2 FINISH MILL FEED BELT

Source Capacity/Throughput: 90.000 Tons/HR CLINKER/GYPSUM

Conditions for this source occur in the following groups: 5 - OTHER NESHAP AFFECTED SOURCES

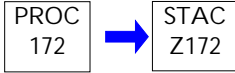
**I. RESTRICTIONS.**

No additional requirements exist except as provided in other sections of this permit including Section B (Title V General Requirements) and/or Section E (Source Group Restrictions).

II. TESTING REQUIREMENTS.

No additional testing requirements exist except as provided in other sections of this permit including Section B (Title V General Requirements) and/or Section E (Source Group Restrictions).

III. MONITORING REQUIREMENTS.

No additional monitoring requirements exist except as provided in other sections of this permit including Section B (Title V General Requirements) and/or Section E (Source Group Restrictions).

IV. RECORDKEEPING REQUIREMENTS.

No additional record keeping requirements exist except as provided in other sections of this permit including Section B (Title V General Requirements) and/or Section E (Source Group Restrictions).

V. REPORTING REQUIREMENTS.

No additional reporting requirements exist except as provided in other sections of this permit including Section B (Title V General Requirements) and/or Section E (Source Group Restrictions).

VI. WORK PRACTICE REQUIREMENTS.

No additional work practice requirements exist except as provided in other sections of this permit including Section B (Title V General Requirements) and/or Section E (Source Group Restrictions).

VII. ADDITIONAL REQUIREMENTS.

No additional requirements exist except as provided in other sections of this permit including Section B (Title V General Requirements) and/or Section E (Source Group Restrictions).

*** Permit Shield in Effect. ***

**SECTION D. Source Level Requirements**

Source ID: 173

Source Name: FEEDER TO #1 KILN FEED ELEVATOR TRANSFER

Source Capacity/Throughput: 52.000 Tons/HR RAW MIX/ESPDUST

Conditions for this source occur in the following groups: 5 - OTHER NESHAP AFFECTED SOURCES

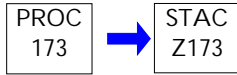
**I. RESTRICTIONS.**

No additional requirements exist except as provided in other sections of this permit including Section B (Title V General Requirements) and/or Section E (Source Group Restrictions).

II. TESTING REQUIREMENTS.

No additional testing requirements exist except as provided in other sections of this permit including Section B (Title V General Requirements) and/or Section E (Source Group Restrictions).

III. MONITORING REQUIREMENTS.

No additional monitoring requirements exist except as provided in other sections of this permit including Section B (Title V General Requirements) and/or Section E (Source Group Restrictions).

IV. RECORDKEEPING REQUIREMENTS.

No additional record keeping requirements exist except as provided in other sections of this permit including Section B (Title V General Requirements) and/or Section E (Source Group Restrictions).

V. REPORTING REQUIREMENTS.

No additional reporting requirements exist except as provided in other sections of this permit including Section B (Title V General Requirements) and/or Section E (Source Group Restrictions).

VI. WORK PRACTICE REQUIREMENTS.

No additional work practice requirements exist except as provided in other sections of this permit including Section B (Title V General Requirements) and/or Section E (Source Group Restrictions).

VII. ADDITIONAL REQUIREMENTS.

No additional requirements exist except as provided in other sections of this permit including Section B (Title V General Requirements) and/or Section E (Source Group Restrictions).

*** Permit Shield in Effect. ***

SECTION D. Source Level Requirements

Source ID: 174

Source Name: FEEDER TO #2 KILN FEED ELEVATOR TRANSFER

Source Capacity/Throughput: 52.000 Tons/HR RAW MIX/ESPDUST

Conditions for this source occur in the following groups: 5 - OTHER NESHAP AFFECTED SOURCES

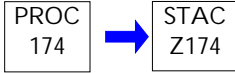
**I. RESTRICTIONS.**

No additional requirements exist except as provided in other sections of this permit including Section B (Title V General Requirements) and/or Section E (Source Group Restrictions).

II. TESTING REQUIREMENTS.

No additional testing requirements exist except as provided in other sections of this permit including Section B (Title V General Requirements) and/or Section E (Source Group Restrictions).

III. MONITORING REQUIREMENTS.

No additional monitoring requirements exist except as provided in other sections of this permit including Section B (Title V General Requirements) and/or Section E (Source Group Restrictions).

IV. RECORDKEEPING REQUIREMENTS.

No additional record keeping requirements exist except as provided in other sections of this permit including Section B (Title V General Requirements) and/or Section E (Source Group Restrictions).

V. REPORTING REQUIREMENTS.

No additional reporting requirements exist except as provided in other sections of this permit including Section B (Title V General Requirements) and/or Section E (Source Group Restrictions).

VI. WORK PRACTICE REQUIREMENTS.

No additional work practice requirements exist except as provided in other sections of this permit including Section B (Title V General Requirements) and/or Section E (Source Group Restrictions).

VII. ADDITIONAL REQUIREMENTS.

No additional requirements exist except as provided in other sections of this permit including Section B (Title V General Requirements) and/or Section E (Source Group Restrictions).

*** Permit Shield in Effect. ***

**SECTION D. Source Level Requirements**

Source ID: 175

Source Name: EAST/WEST TRUCK LOADING #1

Source Capacity/Throughput:

37.000 Tons/HR

CEMENT

Conditions for this source occur in the following groups: 5 - OTHER NESHAP AFFECTED SOURCES

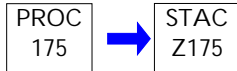
**I. RESTRICTIONS.**

No additional requirements exist except as provided in other sections of this permit including Section B (Title V General Requirements) and/or Section E (Source Group Restrictions).

II. TESTING REQUIREMENTS.

No additional testing requirements exist except as provided in other sections of this permit including Section B (Title V General Requirements) and/or Section E (Source Group Restrictions).

III. MONITORING REQUIREMENTS.

No additional monitoring requirements exist except as provided in other sections of this permit including Section B (Title V General Requirements) and/or Section E (Source Group Restrictions).

IV. RECORDKEEPING REQUIREMENTS.

No additional record keeping requirements exist except as provided in other sections of this permit including Section B (Title V General Requirements) and/or Section E (Source Group Restrictions).

V. REPORTING REQUIREMENTS.

No additional reporting requirements exist except as provided in other sections of this permit including Section B (Title V General Requirements) and/or Section E (Source Group Restrictions).

VI. WORK PRACTICE REQUIREMENTS.

No additional work practice requirements exist except as provided in other sections of this permit including Section B (Title V General Requirements) and/or Section E (Source Group Restrictions).

VII. ADDITIONAL REQUIREMENTS.

No additional requirements exist except as provided in other sections of this permit including Section B (Title V General Requirements) and/or Section E (Source Group Restrictions).

*** Permit Shield in Effect. ***

**SECTION D. Source Level Requirements**

Source ID: 176

Source Name: EAST/WEST TRUCK LOADING #2

Source Capacity/Throughput: 37.000 Tons/HR CEMENT

Conditions for this source occur in the following groups: 5 - OTHER NESHAP AFFECTED SOURCES

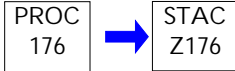
**I. RESTRICTIONS.**

No additional requirements exist except as provided in other sections of this permit including Section B (Title V General Requirements) and/or Section E (Source Group Restrictions).

II. TESTING REQUIREMENTS.

No additional testing requirements exist except as provided in other sections of this permit including Section B (Title V General Requirements) and/or Section E (Source Group Restrictions).

III. MONITORING REQUIREMENTS.

No additional monitoring requirements exist except as provided in other sections of this permit including Section B (Title V General Requirements) and/or Section E (Source Group Restrictions).

IV. RECORDKEEPING REQUIREMENTS.

No additional record keeping requirements exist except as provided in other sections of this permit including Section B (Title V General Requirements) and/or Section E (Source Group Restrictions).

V. REPORTING REQUIREMENTS.

No additional reporting requirements exist except as provided in other sections of this permit including Section B (Title V General Requirements) and/or Section E (Source Group Restrictions).

VI. WORK PRACTICE REQUIREMENTS.

No additional work practice requirements exist except as provided in other sections of this permit including Section B (Title V General Requirements) and/or Section E (Source Group Restrictions).

VII. ADDITIONAL REQUIREMENTS.

No additional requirements exist except as provided in other sections of this permit including Section B (Title V General Requirements) and/or Section E (Source Group Restrictions).

*** Permit Shield in Effect. ***

SECTION D. Source Level Requirements

Source ID: 177

Source Name: NEW TRUCK LOADING

Source Capacity/Throughput: 12.000 Tons/HR CEMENT

Conditions for this source occur in the following groups: 5 - OTHER NESHAP AFFECTED SOURCES

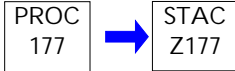

I. RESTRICTIONS.

No additional requirements exist except as provided in other sections of this permit including Section B (Title V General Requirements) and/or Section E (Source Group Restrictions).

II. TESTING REQUIREMENTS.

No additional testing requirements exist except as provided in other sections of this permit including Section B (Title V General Requirements) and/or Section E (Source Group Restrictions).

III. MONITORING REQUIREMENTS.

No additional monitoring requirements exist except as provided in other sections of this permit including Section B (Title V General Requirements) and/or Section E (Source Group Restrictions).

IV. RECORDKEEPING REQUIREMENTS.

No additional record keeping requirements exist except as provided in other sections of this permit including Section B (Title V General Requirements) and/or Section E (Source Group Restrictions).

V. REPORTING REQUIREMENTS.

No additional reporting requirements exist except as provided in other sections of this permit including Section B (Title V General Requirements) and/or Section E (Source Group Restrictions).

VI. WORK PRACTICE REQUIREMENTS.

No additional work practice requirements exist except as provided in other sections of this permit including Section B (Title V General Requirements) and/or Section E (Source Group Restrictions).

VII. ADDITIONAL REQUIREMENTS.

No additional requirements exist except as provided in other sections of this permit including Section B (Title V General Requirements) and/or Section E (Source Group Restrictions).

*** Permit Shield in Effect. ***

**SECTION D. Source Level Requirements**

Source ID: 178

Source Name: RAIL LOADING

Source Capacity/Throughput:

9.000 Tons/HR

CEMENT

Conditions for this source occur in the following groups: 5 - OTHER NESHAP AFFECTED SOURCES

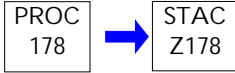
**I. RESTRICTIONS.**

No additional requirements exist except as provided in other sections of this permit including Section B (Title V General Requirements) and/or Section E (Source Group Restrictions).

II. TESTING REQUIREMENTS.

No additional testing requirements exist except as provided in other sections of this permit including Section B (Title V General Requirements) and/or Section E (Source Group Restrictions).

III. MONITORING REQUIREMENTS.

No additional monitoring requirements exist except as provided in other sections of this permit including Section B (Title V General Requirements) and/or Section E (Source Group Restrictions).

IV. RECORDKEEPING REQUIREMENTS.

No additional record keeping requirements exist except as provided in other sections of this permit including Section B (Title V General Requirements) and/or Section E (Source Group Restrictions).

V. REPORTING REQUIREMENTS.

No additional reporting requirements exist except as provided in other sections of this permit including Section B (Title V General Requirements) and/or Section E (Source Group Restrictions).

VI. WORK PRACTICE REQUIREMENTS.

No additional work practice requirements exist except as provided in other sections of this permit including Section B (Title V General Requirements) and/or Section E (Source Group Restrictions).

VII. ADDITIONAL REQUIREMENTS.

No additional requirements exist except as provided in other sections of this permit including Section B (Title V General Requirements) and/or Section E (Source Group Restrictions).

*** Permit Shield in Effect. ***

**SECTION D. Source Level Requirements**

Source ID: 179

Source Name: CLINKER DOME FEEDER TRANSFER

Source Capacity/Throughput: 85.000 Tons/HR CLINKER

Conditions for this source occur in the following groups: 5 - OTHER NESHAP AFFECTED SOURCES

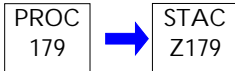
**I. RESTRICTIONS.**

No additional requirements exist except as provided in other sections of this permit including Section B (Title V General Requirements) and/or Section E (Source Group Restrictions).

II. TESTING REQUIREMENTS.

No additional testing requirements exist except as provided in other sections of this permit including Section B (Title V General Requirements) and/or Section E (Source Group Restrictions).

III. MONITORING REQUIREMENTS.

No additional monitoring requirements exist except as provided in other sections of this permit including Section B (Title V General Requirements) and/or Section E (Source Group Restrictions).

IV. RECORDKEEPING REQUIREMENTS.

No additional record keeping requirements exist except as provided in other sections of this permit including Section B (Title V General Requirements) and/or Section E (Source Group Restrictions).

V. REPORTING REQUIREMENTS.

No additional reporting requirements exist except as provided in other sections of this permit including Section B (Title V General Requirements) and/or Section E (Source Group Restrictions).

VI. WORK PRACTICE REQUIREMENTS.

No additional work practice requirements exist except as provided in other sections of this permit including Section B (Title V General Requirements) and/or Section E (Source Group Restrictions).

VII. ADDITIONAL REQUIREMENTS.

No additional requirements exist except as provided in other sections of this permit including Section B (Title V General Requirements) and/or Section E (Source Group Restrictions).

*** Permit Shield in Effect. ***

**SECTION D. Source Level Requirements**

Source ID: 180

Source Name: LIMESTONE PILE

Source Capacity/Throughput:

13.000 Tons/HR

LIMESTONE

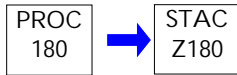
**I. RESTRICTIONS.**

No additional requirements exist except as provided in other sections of this permit including Section B (Title V General Requirements).

II. TESTING REQUIREMENTS.

No additional testing requirements exist except as provided in other sections of this permit including Section B (Title V General Requirements).

III. MONITORING REQUIREMENTS.

No additional monitoring requirements exist except as provided in other sections of this permit including Section B (Title V General Requirements).

IV. RECORDKEEPING REQUIREMENTS.

No additional record keeping requirements exist except as provided in other sections of this permit including Section B (Title V General Requirements).

V. REPORTING REQUIREMENTS.

No additional reporting requirements exist except as provided in other sections of this permit including Section B (Title V General Requirements).

VI. WORK PRACTICE REQUIREMENTS.

No additional work practice requirements exist except as provided in other sections of this permit including Section B (Title V General Requirements).

VII. ADDITIONAL REQUIREMENTS.

No additional requirements exist except as provided in other sections of this permit including Section B (Title V General Requirements).

*** Permit Shield in Effect. ***

**SECTION D. Source Level Requirements**

Source ID: 181

Source Name: COAL PILE

Source Capacity/Throughput: 15.000 Tons/HR COAL

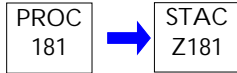
**I. RESTRICTIONS.**

No additional requirements exist except as provided in other sections of this permit including Section B (Title V General Requirements).

II. TESTING REQUIREMENTS.

No additional testing requirements exist except as provided in other sections of this permit including Section B (Title V General Requirements).

III. MONITORING REQUIREMENTS.

No additional monitoring requirements exist except as provided in other sections of this permit including Section B (Title V General Requirements).

IV. RECORDKEEPING REQUIREMENTS.

No additional record keeping requirements exist except as provided in other sections of this permit including Section B (Title V General Requirements).

V. REPORTING REQUIREMENTS.

No additional reporting requirements exist except as provided in other sections of this permit including Section B (Title V General Requirements).

VI. WORK PRACTICE REQUIREMENTS.

No additional work practice requirements exist except as provided in other sections of this permit including Section B (Title V General Requirements).

VII. ADDITIONAL REQUIREMENTS.

No additional requirements exist except as provided in other sections of this permit including Section B (Title V General Requirements).

*** Permit Shield in Effect. ***

**SECTION D. Source Level Requirements**

Source ID: 182

Source Name: GYPSUM PILE

Source Capacity/Throughput:

5.000 Tons/HR

GYPSUM

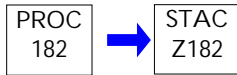
**I. RESTRICTIONS.**

No additional requirements exist except as provided in other sections of this permit including Section B (Title V General Requirements).

II. TESTING REQUIREMENTS.

No additional testing requirements exist except as provided in other sections of this permit including Section B (Title V General Requirements).

III. MONITORING REQUIREMENTS.

No additional monitoring requirements exist except as provided in other sections of this permit including Section B (Title V General Requirements).

IV. RECORDKEEPING REQUIREMENTS.

No additional record keeping requirements exist except as provided in other sections of this permit including Section B (Title V General Requirements).

V. REPORTING REQUIREMENTS.

No additional reporting requirements exist except as provided in other sections of this permit including Section B (Title V General Requirements).

VI. WORK PRACTICE REQUIREMENTS.

No additional work practice requirements exist except as provided in other sections of this permit including Section B (Title V General Requirements).

VII. ADDITIONAL REQUIREMENTS.

No additional requirements exist except as provided in other sections of this permit including Section B (Title V General Requirements).

*** Permit Shield in Effect. ***

**SECTION D. Source Level Requirements**

Source ID: 183

Source Name: CLINKER PILE

Source Capacity/Throughput:

1.000 Tons/HR

CLINKER

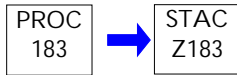
**I. RESTRICTIONS.**

No additional requirements exist except as provided in other sections of this permit including Section B (Title V General Requirements).

II. TESTING REQUIREMENTS.

No additional testing requirements exist except as provided in other sections of this permit including Section B (Title V General Requirements).

III. MONITORING REQUIREMENTS.

No additional monitoring requirements exist except as provided in other sections of this permit including Section B (Title V General Requirements).

IV. RECORDKEEPING REQUIREMENTS.

No additional record keeping requirements exist except as provided in other sections of this permit including Section B (Title V General Requirements).

V. REPORTING REQUIREMENTS.

No additional reporting requirements exist except as provided in other sections of this permit including Section B (Title V General Requirements).

VI. WORK PRACTICE REQUIREMENTS.

No additional work practice requirements exist except as provided in other sections of this permit including Section B (Title V General Requirements).

VII. ADDITIONAL REQUIREMENTS.

No additional requirements exist except as provided in other sections of this permit including Section B (Title V General Requirements).

*** Permit Shield in Effect. ***

**SECTION D. Source Level Requirements**

Source ID: 184

Source Name: UNPAVED ROADS

Source Capacity/Throughput:

5.000 Miles/HR

VEHICLE MILES

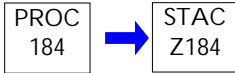
**I. RESTRICTIONS.**

No additional requirements exist except as provided in other sections of this permit including Section B (Title V General Requirements).

II. TESTING REQUIREMENTS.

No additional testing requirements exist except as provided in other sections of this permit including Section B (Title V General Requirements).

III. MONITORING REQUIREMENTS.

No additional monitoring requirements exist except as provided in other sections of this permit including Section B (Title V General Requirements).

IV. RECORDKEEPING REQUIREMENTS.

No additional record keeping requirements exist except as provided in other sections of this permit including Section B (Title V General Requirements).

V. REPORTING REQUIREMENTS.

No additional reporting requirements exist except as provided in other sections of this permit including Section B (Title V General Requirements).

VI. WORK PRACTICE REQUIREMENTS.

No additional work practice requirements exist except as provided in other sections of this permit including Section B (Title V General Requirements).

VII. ADDITIONAL REQUIREMENTS.

No additional requirements exist except as provided in other sections of this permit including Section B (Title V General Requirements).

*** Permit Shield in Effect. ***

**SECTION D. Source Level Requirements**

Source ID: 185

Source Name: PAVED ROADS

Source Capacity/Throughput: 21.000 Miles/HR VEHICLE MILES

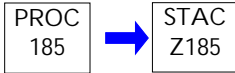
**I. RESTRICTIONS.**

No additional requirements exist except as provided in other sections of this permit including Section B (Title V General Requirements).

II. TESTING REQUIREMENTS.

No additional testing requirements exist except as provided in other sections of this permit including Section B (Title V General Requirements).

III. MONITORING REQUIREMENTS.

No additional monitoring requirements exist except as provided in other sections of this permit including Section B (Title V General Requirements).

IV. RECORDKEEPING REQUIREMENTS.

No additional record keeping requirements exist except as provided in other sections of this permit including Section B (Title V General Requirements).

V. REPORTING REQUIREMENTS.

No additional reporting requirements exist except as provided in other sections of this permit including Section B (Title V General Requirements).

VI. WORK PRACTICE REQUIREMENTS.

No additional work practice requirements exist except as provided in other sections of this permit including Section B (Title V General Requirements).

VII. ADDITIONAL REQUIREMENTS.

No additional requirements exist except as provided in other sections of this permit including Section B (Title V General Requirements).

*** Permit Shield in Effect. ***

**SECTION D. Source Level Requirements**

Source ID: 186

Source Name: GASOLINE TANK

Source Capacity/Throughput:

6.000 Gal/HR

GASOLINE

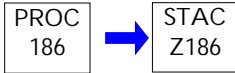
**I. RESTRICTIONS.**

No additional requirements exist except as provided in other sections of this permit including Section B (Title V General Requirements).

II. TESTING REQUIREMENTS.

No additional testing requirements exist except as provided in other sections of this permit including Section B (Title V General Requirements).

III. MONITORING REQUIREMENTS.

No additional monitoring requirements exist except as provided in other sections of this permit including Section B (Title V General Requirements).

IV. RECORDKEEPING REQUIREMENTS.

No additional record keeping requirements exist except as provided in other sections of this permit including Section B (Title V General Requirements).

V. REPORTING REQUIREMENTS.

No additional reporting requirements exist except as provided in other sections of this permit including Section B (Title V General Requirements).

VI. WORK PRACTICE REQUIREMENTS.

No additional work practice requirements exist except as provided in other sections of this permit including Section B (Title V General Requirements).

VII. ADDITIONAL REQUIREMENTS.

No additional requirements exist except as provided in other sections of this permit including Section B (Title V General Requirements).

*** Permit Shield in Effect. ***

**SECTION D. Source Level Requirements**

Source ID: 187

Source Name: LARGE TRUCK FUEL TANK

Source Capacity/Throughput:

70.000 Gal/HR

#2 FUEL OIL

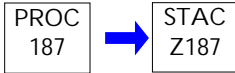
**I. RESTRICTIONS.**

No additional requirements exist except as provided in other sections of this permit including Section B (Title V General Requirements).

II. TESTING REQUIREMENTS.

No additional testing requirements exist except as provided in other sections of this permit including Section B (Title V General Requirements).

III. MONITORING REQUIREMENTS.

No additional monitoring requirements exist except as provided in other sections of this permit including Section B (Title V General Requirements).

IV. RECORDKEEPING REQUIREMENTS.

No additional record keeping requirements exist except as provided in other sections of this permit including Section B (Title V General Requirements).

V. REPORTING REQUIREMENTS.

No additional reporting requirements exist except as provided in other sections of this permit including Section B (Title V General Requirements).

VI. WORK PRACTICE REQUIREMENTS.

No additional work practice requirements exist except as provided in other sections of this permit including Section B (Title V General Requirements).

VII. ADDITIONAL REQUIREMENTS.

No additional requirements exist except as provided in other sections of this permit including Section B (Title V General Requirements).

*** Permit Shield in Effect. ***

**SECTION D. Source Level Requirements**

Source ID: 188

Source Name: SMALL TRUCK FUEL TANK

Source Capacity/Throughput:

70.000 Gal/HR

#2 FUEL OIL

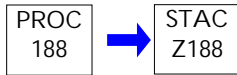
**I. RESTRICTIONS.**

No additional requirements exist except as provided in other sections of this permit including Section B (Title V General Requirements).

II. TESTING REQUIREMENTS.

No additional testing requirements exist except as provided in other sections of this permit including Section B (Title V General Requirements).

III. MONITORING REQUIREMENTS.

No additional monitoring requirements exist except as provided in other sections of this permit including Section B (Title V General Requirements).

IV. RECORDKEEPING REQUIREMENTS.

No additional record keeping requirements exist except as provided in other sections of this permit including Section B (Title V General Requirements).

V. REPORTING REQUIREMENTS.

No additional reporting requirements exist except as provided in other sections of this permit including Section B (Title V General Requirements).

VI. WORK PRACTICE REQUIREMENTS.

No additional work practice requirements exist except as provided in other sections of this permit including Section B (Title V General Requirements).

VII. ADDITIONAL REQUIREMENTS.

No additional requirements exist except as provided in other sections of this permit including Section B (Title V General Requirements).

*** Permit Shield in Effect. ***

**SECTION D. Source Level Requirements**

Source ID: 189

Source Name: KILN LIGHT OFF TANK

Source Capacity/Throughput:

7.000 Gal/HR

#2 FUEL OIL

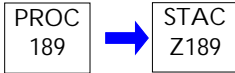
**I. RESTRICTIONS.**

No additional requirements exist except as provided in other sections of this permit including Section B (Title V General Requirements).

II. TESTING REQUIREMENTS.

No additional testing requirements exist except as provided in other sections of this permit including Section B (Title V General Requirements).

III. MONITORING REQUIREMENTS.

No additional monitoring requirements exist except as provided in other sections of this permit including Section B (Title V General Requirements).

IV. RECORDKEEPING REQUIREMENTS.

No additional record keeping requirements exist except as provided in other sections of this permit including Section B (Title V General Requirements).

V. REPORTING REQUIREMENTS.

No additional reporting requirements exist except as provided in other sections of this permit including Section B (Title V General Requirements).

VI. WORK PRACTICE REQUIREMENTS.

No additional work practice requirements exist except as provided in other sections of this permit including Section B (Title V General Requirements).

VII. ADDITIONAL REQUIREMENTS.

No additional requirements exist except as provided in other sections of this permit including Section B (Title V General Requirements).

*** Permit Shield in Effect. ***

**SECTION D. Source Level Requirements**

Source ID: 190

Source Name: DUST SUPPRESSANT TANK

Source Capacity/Throughput: 6.000 Gal/HR DUST SUPPRESS

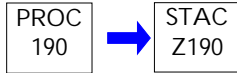
**I. RESTRICTIONS.**

No additional requirements exist except as provided in other sections of this permit including Section B (Title V General Requirements).

II. TESTING REQUIREMENTS.

No additional testing requirements exist except as provided in other sections of this permit including Section B (Title V General Requirements).

III. MONITORING REQUIREMENTS.

No additional monitoring requirements exist except as provided in other sections of this permit including Section B (Title V General Requirements).

IV. RECORDKEEPING REQUIREMENTS.

No additional record keeping requirements exist except as provided in other sections of this permit including Section B (Title V General Requirements).

V. REPORTING REQUIREMENTS.

No additional reporting requirements exist except as provided in other sections of this permit including Section B (Title V General Requirements).

VI. WORK PRACTICE REQUIREMENTS.

No additional work practice requirements exist except as provided in other sections of this permit including Section B (Title V General Requirements).

VII. ADDITIONAL REQUIREMENTS.

No additional requirements exist except as provided in other sections of this permit including Section B (Title V General Requirements).

*** Permit Shield in Effect. ***

**SECTION D. Source Level Requirements**

Source ID: 191

Source Name: GRINDING AID TANK

Source Capacity/Throughput: 7.000 Gal/HR DIETHYLENE GLYC

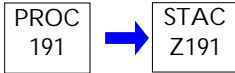
**I. RESTRICTIONS.**

No additional requirements exist except as provided in other sections of this permit including Section B (Title V General Requirements).

II. TESTING REQUIREMENTS.

No additional testing requirements exist except as provided in other sections of this permit including Section B (Title V General Requirements).

III. MONITORING REQUIREMENTS.

No additional monitoring requirements exist except as provided in other sections of this permit including Section B (Title V General Requirements).

IV. RECORDKEEPING REQUIREMENTS.

No additional record keeping requirements exist except as provided in other sections of this permit including Section B (Title V General Requirements).

V. REPORTING REQUIREMENTS.

No additional reporting requirements exist except as provided in other sections of this permit including Section B (Title V General Requirements).

VI. WORK PRACTICE REQUIREMENTS.

No additional work practice requirements exist except as provided in other sections of this permit including Section B (Title V General Requirements).

VII. ADDITIONAL REQUIREMENTS.

No additional requirements exist except as provided in other sections of this permit including Section B (Title V General Requirements).

*** Permit Shield in Effect. ***

**SECTION D. Source Level Requirements**

Source ID: 192

Source Name: AIR ENTRAINING AGENT TANK

Source Capacity/Throughput: 2,000 Gal/HR TALL OIL/SOAP

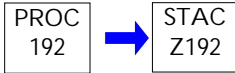
**I. RESTRICTIONS.**

No additional requirements exist except as provided in other sections of this permit including Section B (Title V General Requirements).

II. TESTING REQUIREMENTS.

No additional testing requirements exist except as provided in other sections of this permit including Section B (Title V General Requirements).

III. MONITORING REQUIREMENTS.

No additional monitoring requirements exist except as provided in other sections of this permit including Section B (Title V General Requirements).

IV. RECORDKEEPING REQUIREMENTS.

No additional record keeping requirements exist except as provided in other sections of this permit including Section B (Title V General Requirements).

V. REPORTING REQUIREMENTS.

No additional reporting requirements exist except as provided in other sections of this permit including Section B (Title V General Requirements).

VI. WORK PRACTICE REQUIREMENTS.

No additional work practice requirements exist except as provided in other sections of this permit including Section B (Title V General Requirements).

VII. ADDITIONAL REQUIREMENTS.

No additional requirements exist except as provided in other sections of this permit including Section B (Title V General Requirements).

*** Permit Shield in Effect. ***

**SECTION D. Source Level Requirements**

Source ID: 193

Source Name: USED OIL TANK #1

Source Capacity/Throughput:

1.000 Gal/HR

WASTE OIL

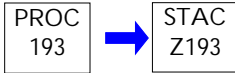
**I. RESTRICTIONS.**

No additional requirements exist except as provided in other sections of this permit including Section B (Title V General Requirements).

II. TESTING REQUIREMENTS.

No additional testing requirements exist except as provided in other sections of this permit including Section B (Title V General Requirements).

III. MONITORING REQUIREMENTS.

No additional monitoring requirements exist except as provided in other sections of this permit including Section B (Title V General Requirements).

IV. RECORDKEEPING REQUIREMENTS.

No additional record keeping requirements exist except as provided in other sections of this permit including Section B (Title V General Requirements).

V. REPORTING REQUIREMENTS.

No additional reporting requirements exist except as provided in other sections of this permit including Section B (Title V General Requirements).

VI. WORK PRACTICE REQUIREMENTS.

No additional work practice requirements exist except as provided in other sections of this permit including Section B (Title V General Requirements).

VII. ADDITIONAL REQUIREMENTS.

No additional requirements exist except as provided in other sections of this permit including Section B (Title V General Requirements).

*** Permit Shield in Effect. ***

**SECTION D. Source Level Requirements**

Source ID: 194

Source Name: USED OIL TANK #2

Source Capacity/Throughput:

1.000 Gal/HR

WASTE OIL

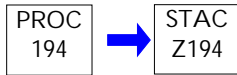
**I. RESTRICTIONS.**

No additional requirements exist except as provided in other sections of this permit including Section B (Title V General Requirements).

II. TESTING REQUIREMENTS.

No additional testing requirements exist except as provided in other sections of this permit including Section B (Title V General Requirements).

III. MONITORING REQUIREMENTS.

No additional monitoring requirements exist except as provided in other sections of this permit including Section B (Title V General Requirements).

IV. RECORDKEEPING REQUIREMENTS.

No additional record keeping requirements exist except as provided in other sections of this permit including Section B (Title V General Requirements).

V. REPORTING REQUIREMENTS.

No additional reporting requirements exist except as provided in other sections of this permit including Section B (Title V General Requirements).

VI. WORK PRACTICE REQUIREMENTS.

No additional work practice requirements exist except as provided in other sections of this permit including Section B (Title V General Requirements).

VII. ADDITIONAL REQUIREMENTS.

No additional requirements exist except as provided in other sections of this permit including Section B (Title V General Requirements).

*** Permit Shield in Effect. ***

**SECTION D. Source Level Requirements**

Source ID: 195

Source Name: #1 RAW MILL & SEPARATOR

Source Capacity/Throughput:	43.000 Tons/HR	RAW MIX
	43.000 Tons/HR	RAW MIX

Conditions for this source occur in the following groups: 1 - SOURCES WITH BAGHOUSES
4 - RAW AND FINISH MILL NESHAP REQ.

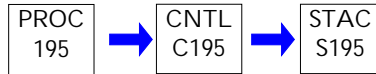
**I. RESTRICTIONS.**

No additional requirements exist except as provided in other sections of this permit including Section B (Title V General Requirements) and/or Section E (Source Group Restrictions).

II. TESTING REQUIREMENTS.

No additional testing requirements exist except as provided in other sections of this permit including Section B (Title V General Requirements) and/or Section E (Source Group Restrictions).

III. MONITORING REQUIREMENTS.

No additional monitoring requirements exist except as provided in other sections of this permit including Section B (Title V General Requirements) and/or Section E (Source Group Restrictions).

IV. RECORDKEEPING REQUIREMENTS.

No additional record keeping requirements exist except as provided in other sections of this permit including Section B (Title V General Requirements) and/or Section E (Source Group Restrictions).

V. REPORTING REQUIREMENTS.

No additional reporting requirements exist except as provided in other sections of this permit including Section B (Title V General Requirements) and/or Section E (Source Group Restrictions).

VI. WORK PRACTICE REQUIREMENTS.

No additional work practice requirements exist except as provided in other sections of this permit including Section B (Title V General Requirements) and/or Section E (Source Group Restrictions).

VII. ADDITIONAL REQUIREMENTS.

No additional requirements exist except as provided in other sections of this permit including Section B (Title V General Requirements) and/or Section E (Source Group Restrictions).

*** Permit Shield in Effect. ***

SECTION D. Source Level Requirements

Source ID: 196

Source Name: #2 RAW MILL & SEPARATOR

Source Capacity/Throughput:	55.000 Tons/HR	RAW MIX
	43.000 Tons/HR	RAW MIX

Conditions for this source occur in the following groups: 1 - SOURCES WITH BAGHOUSES
4 - RAW AND FINISH MILL NESHAP REQ.

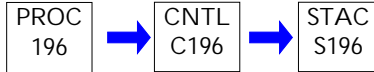
**I. RESTRICTIONS.**

No additional requirements exist except as provided in other sections of this permit including Section B (Title V General Requirements) and/or Section E (Source Group Restrictions).

II. TESTING REQUIREMENTS.

No additional testing requirements exist except as provided in other sections of this permit including Section B (Title V General Requirements) and/or Section E (Source Group Restrictions).

III. MONITORING REQUIREMENTS.

No additional monitoring requirements exist except as provided in other sections of this permit including Section B (Title V General Requirements) and/or Section E (Source Group Restrictions).

IV. RECORDKEEPING REQUIREMENTS.

No additional record keeping requirements exist except as provided in other sections of this permit including Section B (Title V General Requirements) and/or Section E (Source Group Restrictions).

V. REPORTING REQUIREMENTS.

No additional reporting requirements exist except as provided in other sections of this permit including Section B (Title V General Requirements) and/or Section E (Source Group Restrictions).

VI. WORK PRACTICE REQUIREMENTS.

No additional work practice requirements exist except as provided in other sections of this permit including Section B (Title V General Requirements) and/or Section E (Source Group Restrictions).

VII. ADDITIONAL REQUIREMENTS.

No additional requirements exist except as provided in other sections of this permit including Section B (Title V General Requirements) and/or Section E (Source Group Restrictions).

*** Permit Shield in Effect. ***

**SECTION D. Source Level Requirements**

Source ID: 197

Source Name: #3 RAW MILL & SEPARATOR

Source Capacity/Throughput:	75.000 Tons/HR	RAW MIX
	56.000 Tons/HR	RAW MIX

Conditions for this source occur in the following groups: 1 - SOURCES WITH BAGHOUSES
4 - RAW AND FINISH MILL NESHAP REQ.

**I. RESTRICTIONS.**

No additional requirements exist except as provided in other sections of this permit including Section B (Title V General Requirements) and/or Section E (Source Group Restrictions).

II. TESTING REQUIREMENTS.

No additional testing requirements exist except as provided in other sections of this permit including Section B (Title V General Requirements) and/or Section E (Source Group Restrictions).

III. MONITORING REQUIREMENTS.

No additional monitoring requirements exist except as provided in other sections of this permit including Section B (Title V General Requirements) and/or Section E (Source Group Restrictions).

IV. RECORDKEEPING REQUIREMENTS.

No additional record keeping requirements exist except as provided in other sections of this permit including Section B (Title V General Requirements) and/or Section E (Source Group Restrictions).

V. REPORTING REQUIREMENTS.

No additional reporting requirements exist except as provided in other sections of this permit including Section B (Title V General Requirements) and/or Section E (Source Group Restrictions).

VI. WORK PRACTICE REQUIREMENTS.

No additional work practice requirements exist except as provided in other sections of this permit including Section B (Title V General Requirements) and/or Section E (Source Group Restrictions).

VII. ADDITIONAL REQUIREMENTS.

No additional requirements exist except as provided in other sections of this permit including Section B (Title V General Requirements) and/or Section E (Source Group Restrictions).

*** Permit Shield in Effect. ***

SECTION D. Source Level Requirements

Source ID: 198

Source Name: TRANSFER STATION

Source Capacity/Throughput: 85.000 Tons/HR CLINKER

Conditions for this source occur in the following groups: 1C - CLINKER TRANSFER SYSTEM B.H. (NEW)
5 - OTHER NESHAP AFFECTED SOURCES

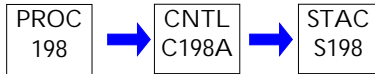
**I. RESTRICTIONS.**

No additional requirements exist except as provided in other sections of this permit including Section B (Title V General Requirements) and/or Section E (Source Group Restrictions).

II. TESTING REQUIREMENTS.

No additional testing requirements exist except as provided in other sections of this permit including Section B (Title V General Requirements) and/or Section E (Source Group Restrictions).

III. MONITORING REQUIREMENTS.

No additional monitoring requirements exist except as provided in other sections of this permit including Section B (Title V General Requirements) and/or Section E (Source Group Restrictions).

IV. RECORDKEEPING REQUIREMENTS.

No additional record keeping requirements exist except as provided in other sections of this permit including Section B (Title V General Requirements) and/or Section E (Source Group Restrictions).

V. REPORTING REQUIREMENTS.

No additional reporting requirements exist except as provided in other sections of this permit including Section B (Title V General Requirements) and/or Section E (Source Group Restrictions).

VI. WORK PRACTICE REQUIREMENTS.

No additional work practice requirements exist except as provided in other sections of this permit including Section B (Title V General Requirements) and/or Section E (Source Group Restrictions).

VII. ADDITIONAL REQUIREMENTS.

No additional requirements exist except as provided in other sections of this permit including Section B (Title V General Requirements) and/or Section E (Source Group Restrictions).

*** Permit Shield in Effect. ***

**SECTION D. Source Level Requirements**

Source ID: 199

Source Name: 3101 BELT & 3102 BELT

Source Capacity/Throughput: 32.000 Tons/HR CLINKER

Conditions for this source occur in the following groups: 1C - CLINKER TRANSFER SYSTEM B.H. (NEW)
5 - OTHER NESHAP AFFECTED SOURCES

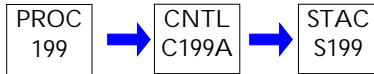
**I. RESTRICTIONS.**

No additional requirements exist except as provided in other sections of this permit including Section B (Title V General Requirements) and/or Section E (Source Group Restrictions).

II. TESTING REQUIREMENTS.

No additional testing requirements exist except as provided in other sections of this permit including Section B (Title V General Requirements) and/or Section E (Source Group Restrictions).

III. MONITORING REQUIREMENTS.

No additional monitoring requirements exist except as provided in other sections of this permit including Section B (Title V General Requirements) and/or Section E (Source Group Restrictions).

IV. RECORDKEEPING REQUIREMENTS.

No additional record keeping requirements exist except as provided in other sections of this permit including Section B (Title V General Requirements) and/or Section E (Source Group Restrictions).

V. REPORTING REQUIREMENTS.

No additional reporting requirements exist except as provided in other sections of this permit including Section B (Title V General Requirements) and/or Section E (Source Group Restrictions).

VI. WORK PRACTICE REQUIREMENTS.

No additional work practice requirements exist except as provided in other sections of this permit including Section B (Title V General Requirements) and/or Section E (Source Group Restrictions).

VII. ADDITIONAL REQUIREMENTS.

No additional requirements exist except as provided in other sections of this permit including Section B (Title V General Requirements) and/or Section E (Source Group Restrictions).

*** Permit Shield in Effect. ***

**SECTION D. Source Level Requirements**

Source ID: 200

Source Name: GRAVEL BED FILTER DUST SILO

Source Capacity/Throughput: 1.000 Tons/HR GBF DUST

Conditions for this source occur in the following groups: 1 - SOURCES WITH BAGHOUSES
5 - OTHER NESHAP AFFECTED SOURCES

**I. RESTRICTIONS.**

No additional requirements exist except as provided in other sections of this permit including Section B (Title V General Requirements) and/or Section E (Source Group Restrictions).

II. TESTING REQUIREMENTS.

No additional testing requirements exist except as provided in other sections of this permit including Section B (Title V General Requirements) and/or Section E (Source Group Restrictions).

III. MONITORING REQUIREMENTS.

No additional monitoring requirements exist except as provided in other sections of this permit including Section B (Title V General Requirements) and/or Section E (Source Group Restrictions).

IV. RECORDKEEPING REQUIREMENTS.

No additional record keeping requirements exist except as provided in other sections of this permit including Section B (Title V General Requirements) and/or Section E (Source Group Restrictions).

V. REPORTING REQUIREMENTS.

No additional reporting requirements exist except as provided in other sections of this permit including Section B (Title V General Requirements) and/or Section E (Source Group Restrictions).

VI. WORK PRACTICE REQUIREMENTS.

No additional work practice requirements exist except as provided in other sections of this permit including Section B (Title V General Requirements) and/or Section E (Source Group Restrictions).

VII. ADDITIONAL REQUIREMENTS.

No additional requirements exist except as provided in other sections of this permit including Section B (Title V General Requirements) and/or Section E (Source Group Restrictions).

*** Permit Shield in Effect. ***

**SECTION D. Source Level Requirements**

Source ID: 201

Source Name: KILN DUST (EARTH PLUS) TANK

Source Capacity/Throughput:

1.000 Tons/HR

EARTH PLUS

Conditions for this source occur in the following groups: 1 - SOURCES WITH BAGHOUSES
5 - OTHER NESHAP AFFECTED SOURCES

**I. RESTRICTIONS.**

No additional requirements exist except as provided in other sections of this permit including Section B (Title V General Requirements) and/or Section E (Source Group Restrictions).

II. TESTING REQUIREMENTS.

No additional testing requirements exist except as provided in other sections of this permit including Section B (Title V General Requirements) and/or Section E (Source Group Restrictions).

III. MONITORING REQUIREMENTS.

No additional monitoring requirements exist except as provided in other sections of this permit including Section B (Title V General Requirements) and/or Section E (Source Group Restrictions).

IV. RECORDKEEPING REQUIREMENTS.

No additional record keeping requirements exist except as provided in other sections of this permit including Section B (Title V General Requirements) and/or Section E (Source Group Restrictions).

V. REPORTING REQUIREMENTS.

No additional reporting requirements exist except as provided in other sections of this permit including Section B (Title V General Requirements) and/or Section E (Source Group Restrictions).

VI. WORK PRACTICE REQUIREMENTS.

No additional work practice requirements exist except as provided in other sections of this permit including Section B (Title V General Requirements) and/or Section E (Source Group Restrictions).

VII. ADDITIONAL REQUIREMENTS.

No additional requirements exist except as provided in other sections of this permit including Section B (Title V General Requirements) and/or Section E (Source Group Restrictions).

*** Permit Shield in Effect. ***

**SECTION D. Source Level Requirements**

Source ID: 202

Source Name: 3104 BELT & 3105 BELT

Source Capacity/Throughput:	100.000 Tons/HR	CLINKER
	81.000 Tons/HR	CLINKER

Conditions for this source occur in the following groups: 1C - CLINKER TRANSFER SYSTEM B.H. (NEW)
5 - OTHER NESHAP AFFECTED SOURCES

**I. RESTRICTIONS.**

No additional requirements exist except as provided in other sections of this permit including Section B (Title V General Requirements) and/or Section E (Source Group Restrictions).

II. TESTING REQUIREMENTS.

No additional testing requirements exist except as provided in other sections of this permit including Section B (Title V General Requirements) and/or Section E (Source Group Restrictions).

III. MONITORING REQUIREMENTS.

No additional monitoring requirements exist except as provided in other sections of this permit including Section B (Title V General Requirements) and/or Section E (Source Group Restrictions).

IV. RECORDKEEPING REQUIREMENTS.

No additional record keeping requirements exist except as provided in other sections of this permit including Section B (Title V General Requirements) and/or Section E (Source Group Restrictions).

V. REPORTING REQUIREMENTS.

No additional reporting requirements exist except as provided in other sections of this permit including Section B (Title V General Requirements) and/or Section E (Source Group Restrictions).

VI. WORK PRACTICE REQUIREMENTS.

No additional work practice requirements exist except as provided in other sections of this permit including Section B (Title V General Requirements) and/or Section E (Source Group Restrictions).

VII. ADDITIONAL REQUIREMENTS.

No additional requirements exist except as provided in other sections of this permit including Section B (Title V General Requirements) and/or Section E (Source Group Restrictions).

*** Permit Shield in Effect. ***

**SECTION D. Source Level Requirements**

Source ID: 203

Source Name: CLINKER STORAGE BUILDING

Source Capacity/Throughput:	100.000 Tons/HR	CLINKER
	86.000 Tons/HR	CLINKER/GBFDUST

Conditions for this source occur in the following groups: 1 - SOURCES WITH BAGHOUSES
5 - OTHER NESHAP AFFECTED SOURCES

**I. RESTRICTIONS.**

No additional requirements exist except as provided in other sections of this permit including Section B (Title V General Requirements) and/or Section E (Source Group Restrictions).

II. TESTING REQUIREMENTS.

No additional testing requirements exist except as provided in other sections of this permit including Section B (Title V General Requirements) and/or Section E (Source Group Restrictions).

III. MONITORING REQUIREMENTS.

No additional monitoring requirements exist except as provided in other sections of this permit including Section B (Title V General Requirements) and/or Section E (Source Group Restrictions).

IV. RECORDKEEPING REQUIREMENTS.

No additional record keeping requirements exist except as provided in other sections of this permit including Section B (Title V General Requirements) and/or Section E (Source Group Restrictions).

V. REPORTING REQUIREMENTS.

No additional reporting requirements exist except as provided in other sections of this permit including Section B (Title V General Requirements) and/or Section E (Source Group Restrictions).

VI. WORK PRACTICE REQUIREMENTS.

No additional work practice requirements exist except as provided in other sections of this permit including Section B (Title V General Requirements) and/or Section E (Source Group Restrictions).

VII. ADDITIONAL REQUIREMENTS.

No additional requirements exist except as provided in other sections of this permit including Section B (Title V General Requirements) and/or Section E (Source Group Restrictions).

*** Permit Shield in Effect. ***

SECTION D. Source Level Requirements

Source ID: 204

Source Name: CLINKER DOME AND TUNNEL

Source Capacity/Throughput:	100.000 Tons/HR	CLINKER
	81.000 Tons/HR	CLINKER

Conditions for this source occur in the following groups: 1 - SOURCES WITH BAGHOUSES
5 - OTHER NESHAP AFFECTED SOURCES

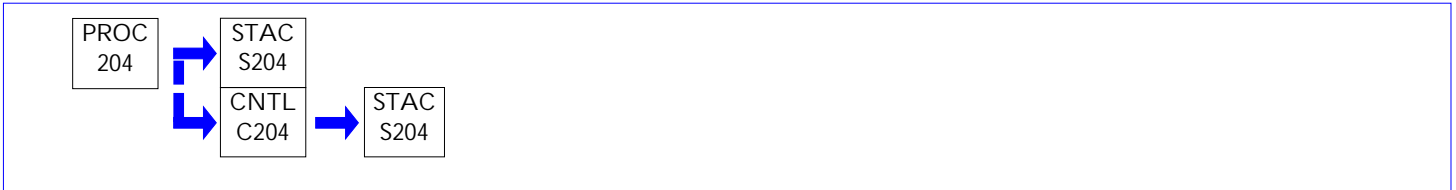
**I. RESTRICTIONS.**

No additional requirements exist except as provided in other sections of this permit including Section B (Title V General Requirements) and/or Section E (Source Group Restrictions).

II. TESTING REQUIREMENTS.

No additional testing requirements exist except as provided in other sections of this permit including Section B (Title V General Requirements) and/or Section E (Source Group Restrictions).

III. MONITORING REQUIREMENTS.

No additional monitoring requirements exist except as provided in other sections of this permit including Section B (Title V General Requirements) and/or Section E (Source Group Restrictions).

IV. RECORDKEEPING REQUIREMENTS.

No additional record keeping requirements exist except as provided in other sections of this permit including Section B (Title V General Requirements) and/or Section E (Source Group Restrictions).

V. REPORTING REQUIREMENTS.

No additional reporting requirements exist except as provided in other sections of this permit including Section B (Title V General Requirements) and/or Section E (Source Group Restrictions).

VI. WORK PRACTICE REQUIREMENTS.

No additional work practice requirements exist except as provided in other sections of this permit including Section B (Title V General Requirements) and/or Section E (Source Group Restrictions).

VII. ADDITIONAL REQUIREMENTS.

No additional requirements exist except as provided in other sections of this permit including Section B (Title V General Requirements) and/or Section E (Source Group Restrictions).

*** Permit Shield in Effect. ***

SECTION D. Source Level Requirements

Source ID: 205

Source Name: #1 & #2 KILN FEED ELEVATOR

Source Capacity/Throughput: 21.000 Tons/HR RAW MIX/ESPDUST

Conditions for this source occur in the following groups: 1 - SOURCES WITH BAGHOUSES
5 - OTHER NESHAP AFFECTED SOURCES

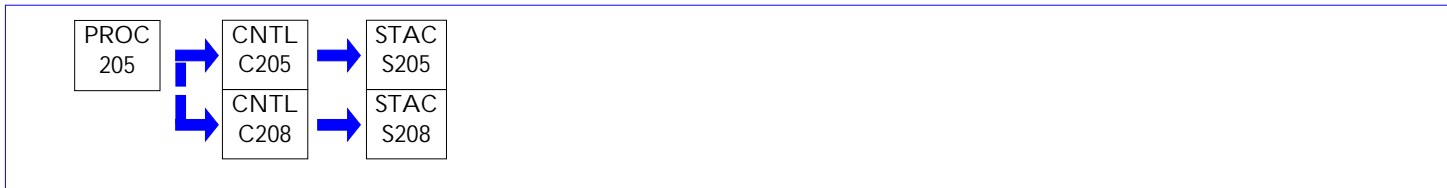
**I. RESTRICTIONS.**

No additional requirements exist except as provided in other sections of this permit including Section B (Title V General Requirements) and/or Section E (Source Group Restrictions).

II. TESTING REQUIREMENTS.

No additional testing requirements exist except as provided in other sections of this permit including Section B (Title V General Requirements) and/or Section E (Source Group Restrictions).

III. MONITORING REQUIREMENTS.

No additional monitoring requirements exist except as provided in other sections of this permit including Section B (Title V General Requirements) and/or Section E (Source Group Restrictions).

IV. RECORDKEEPING REQUIREMENTS.

No additional record keeping requirements exist except as provided in other sections of this permit including Section B (Title V General Requirements) and/or Section E (Source Group Restrictions).

V. REPORTING REQUIREMENTS.

No additional reporting requirements exist except as provided in other sections of this permit including Section B (Title V General Requirements) and/or Section E (Source Group Restrictions).

VI. WORK PRACTICE REQUIREMENTS.

No additional work practice requirements exist except as provided in other sections of this permit including Section B (Title V General Requirements) and/or Section E (Source Group Restrictions).

VII. ADDITIONAL REQUIREMENTS.

No additional requirements exist except as provided in other sections of this permit including Section B (Title V General Requirements) and/or Section E (Source Group Restrictions).

*** Permit Shield in Effect. ***

**SECTION D. Source Level Requirements**

Source ID: 206

Source Name: #1 & #3 HOMOGENIZING SILOS

Source Capacity/Throughput: 142.000 Tons/HR RAW MIX

Conditions for this source occur in the following groups: 1 - SOURCES WITH BAGHOUSES
5 - OTHER NESHAP AFFECTED SOURCES

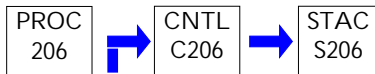
**I. RESTRICTIONS.**

No additional requirements exist except as provided in other sections of this permit including Section B (Title V General Requirements) and/or Section E (Source Group Restrictions).

II. TESTING REQUIREMENTS.

No additional testing requirements exist except as provided in other sections of this permit including Section B (Title V General Requirements) and/or Section E (Source Group Restrictions).

III. MONITORING REQUIREMENTS.

No additional monitoring requirements exist except as provided in other sections of this permit including Section B (Title V General Requirements) and/or Section E (Source Group Restrictions).

IV. RECORDKEEPING REQUIREMENTS.

No additional record keeping requirements exist except as provided in other sections of this permit including Section B (Title V General Requirements) and/or Section E (Source Group Restrictions).

V. REPORTING REQUIREMENTS.

No additional reporting requirements exist except as provided in other sections of this permit including Section B (Title V General Requirements) and/or Section E (Source Group Restrictions).

VI. WORK PRACTICE REQUIREMENTS.

No additional work practice requirements exist except as provided in other sections of this permit including Section B (Title V General Requirements) and/or Section E (Source Group Restrictions).

VII. ADDITIONAL REQUIREMENTS.

No additional requirements exist except as provided in other sections of this permit including Section B (Title V General Requirements) and/or Section E (Source Group Restrictions).

*** Permit Shield in Effect. ***

**SECTION D. Source Level Requirements**

Source ID: 207

Source Name: #5 HOMOGENIZING SILO

Source Capacity/Throughput: 53.000 Tons/HR RAW MIX

Conditions for this source occur in the following groups: 1 - SOURCES WITH BAGHOUSES
5 - OTHER NESHAP AFFECTED SOURCES

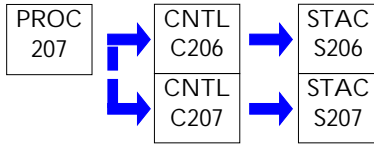
**I. RESTRICTIONS.**

No additional requirements exist except as provided in other sections of this permit including Section B (Title V General Requirements) and/or Section E (Source Group Restrictions).

II. TESTING REQUIREMENTS.

No additional testing requirements exist except as provided in other sections of this permit including Section B (Title V General Requirements) and/or Section E (Source Group Restrictions).

III. MONITORING REQUIREMENTS.

No additional monitoring requirements exist except as provided in other sections of this permit including Section B (Title V General Requirements) and/or Section E (Source Group Restrictions).

IV. RECORDKEEPING REQUIREMENTS.

No additional record keeping requirements exist except as provided in other sections of this permit including Section B (Title V General Requirements) and/or Section E (Source Group Restrictions).

V. REPORTING REQUIREMENTS.

No additional reporting requirements exist except as provided in other sections of this permit including Section B (Title V General Requirements) and/or Section E (Source Group Restrictions).

VI. WORK PRACTICE REQUIREMENTS.

No additional work practice requirements exist except as provided in other sections of this permit including Section B (Title V General Requirements) and/or Section E (Source Group Restrictions).

VII. ADDITIONAL REQUIREMENTS.

No additional requirements exist except as provided in other sections of this permit including Section B (Title V General Requirements) and/or Section E (Source Group Restrictions).

*** Permit Shield in Effect. ***

**SECTION D. Source Level Requirements**

Source ID: 208

Source Name: SURGE BIN

Source Capacity/Throughput: 90.000 Tons/HR RAW MIX

Conditions for this source occur in the following groups: 1 - SOURCES WITH BAGHOUSES
5 - OTHER NESHAP AFFECTED SOURCES

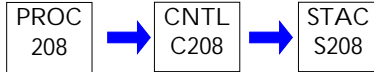
**I. RESTRICTIONS.**

No additional requirements exist except as provided in other sections of this permit including Section B (Title V General Requirements) and/or Section E (Source Group Restrictions).

II. TESTING REQUIREMENTS.

No additional testing requirements exist except as provided in other sections of this permit including Section B (Title V General Requirements) and/or Section E (Source Group Restrictions).

III. MONITORING REQUIREMENTS.

No additional monitoring requirements exist except as provided in other sections of this permit including Section B (Title V General Requirements) and/or Section E (Source Group Restrictions).

IV. RECORDKEEPING REQUIREMENTS.

No additional record keeping requirements exist except as provided in other sections of this permit including Section B (Title V General Requirements) and/or Section E (Source Group Restrictions).

V. REPORTING REQUIREMENTS.

No additional reporting requirements exist except as provided in other sections of this permit including Section B (Title V General Requirements) and/or Section E (Source Group Restrictions).

VI. WORK PRACTICE REQUIREMENTS.

No additional work practice requirements exist except as provided in other sections of this permit including Section B (Title V General Requirements) and/or Section E (Source Group Restrictions).

VII. ADDITIONAL REQUIREMENTS.

No additional requirements exist except as provided in other sections of this permit including Section B (Title V General Requirements) and/or Section E (Source Group Restrictions).

*** Permit Shield in Effect. ***

**SECTION D. Source Level Requirements**

Source ID: 209

Source Name: EAST CEMENT SILOS

Source Capacity/Throughput:	40.000 Tons/HR	CEMENT
	47.000 Tons/HR	CEMENT
	150.000 Tons/HR	CEMENT

Conditions for this source occur in the following groups: 1 - SOURCES WITH BAGHOUSES
5 - OTHER NESHAP AFFECTED SOURCES

**I. RESTRICTIONS.**

No additional requirements exist except as provided in other sections of this permit including Section B (Title V General Requirements) and/or Section E (Source Group Restrictions).

II. TESTING REQUIREMENTS.

No additional testing requirements exist except as provided in other sections of this permit including Section B (Title V General Requirements) and/or Section E (Source Group Restrictions).

III. MONITORING REQUIREMENTS.

No additional monitoring requirements exist except as provided in other sections of this permit including Section B (Title V General Requirements) and/or Section E (Source Group Restrictions).

IV. RECORDKEEPING REQUIREMENTS.

No additional record keeping requirements exist except as provided in other sections of this permit including Section B (Title V General Requirements) and/or Section E (Source Group Restrictions).

V. REPORTING REQUIREMENTS.

No additional reporting requirements exist except as provided in other sections of this permit including Section B (Title V General Requirements) and/or Section E (Source Group Restrictions).

VI. WORK PRACTICE REQUIREMENTS.

No additional work practice requirements exist except as provided in other sections of this permit including Section B (Title V General Requirements) and/or Section E (Source Group Restrictions).

VII. ADDITIONAL REQUIREMENTS.

No additional requirements exist except as provided in other sections of this permit including Section B (Title V General Requirements) and/or Section E (Source Group Restrictions).

*** Permit Shield in Effect. ***

**SECTION D. Source Level Requirements**

Source ID: 210

Source Name: WEST CEMENT SILOS

Source Capacity/Throughput: 47.000 Tons/HR CEMENT

Conditions for this source occur in the following groups: 1 - SOURCES WITH BAGHOUSES
5 - OTHER NESHAP AFFECTED SOURCES

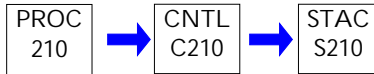
**I. RESTRICTIONS.**

No additional requirements exist except as provided in other sections of this permit including Section B (Title V General Requirements) and/or Section E (Source Group Restrictions).

II. TESTING REQUIREMENTS.

No additional testing requirements exist except as provided in other sections of this permit including Section B (Title V General Requirements) and/or Section E (Source Group Restrictions).

III. MONITORING REQUIREMENTS.

No additional monitoring requirements exist except as provided in other sections of this permit including Section B (Title V General Requirements) and/or Section E (Source Group Restrictions).

IV. RECORDKEEPING REQUIREMENTS.

No additional record keeping requirements exist except as provided in other sections of this permit including Section B (Title V General Requirements) and/or Section E (Source Group Restrictions).

V. REPORTING REQUIREMENTS.

No additional reporting requirements exist except as provided in other sections of this permit including Section B (Title V General Requirements) and/or Section E (Source Group Restrictions).

VI. WORK PRACTICE REQUIREMENTS.

No additional work practice requirements exist except as provided in other sections of this permit including Section B (Title V General Requirements) and/or Section E (Source Group Restrictions).

VII. ADDITIONAL REQUIREMENTS.

No additional requirements exist except as provided in other sections of this permit including Section B (Title V General Requirements) and/or Section E (Source Group Restrictions).

*** Permit Shield in Effect. ***

**SECTION D. Source Level Requirements**

Source ID: 211

Source Name: #1 - #4 CEMENT SILOS

Source Capacity/Throughput: 4.000 Tons/HR CEMENT

Conditions for this source occur in the following groups: 1 - SOURCES WITH BAGHOUSES
5 - OTHER NESHAP AFFECTED SOURCES

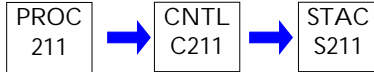
**I. RESTRICTIONS.**

No additional requirements exist except as provided in other sections of this permit including Section B (Title V General Requirements) and/or Section E (Source Group Restrictions).

II. TESTING REQUIREMENTS.

No additional testing requirements exist except as provided in other sections of this permit including Section B (Title V General Requirements) and/or Section E (Source Group Restrictions).

III. MONITORING REQUIREMENTS.

No additional monitoring requirements exist except as provided in other sections of this permit including Section B (Title V General Requirements) and/or Section E (Source Group Restrictions).

IV. RECORDKEEPING REQUIREMENTS.

No additional record keeping requirements exist except as provided in other sections of this permit including Section B (Title V General Requirements) and/or Section E (Source Group Restrictions).

V. REPORTING REQUIREMENTS.

No additional reporting requirements exist except as provided in other sections of this permit including Section B (Title V General Requirements) and/or Section E (Source Group Restrictions).

VI. WORK PRACTICE REQUIREMENTS.

No additional work practice requirements exist except as provided in other sections of this permit including Section B (Title V General Requirements) and/or Section E (Source Group Restrictions).

VII. ADDITIONAL REQUIREMENTS.

No additional requirements exist except as provided in other sections of this permit including Section B (Title V General Requirements) and/or Section E (Source Group Restrictions).

*** Permit Shield in Effect. ***

**SECTION D. Source Level Requirements**

Source ID: 212

Source Name: MASONRY CEMENT SILO

Source Capacity/Throughput: 12.000 Tons/HR CEMENT

Conditions for this source occur in the following groups: 1 - SOURCES WITH BAGHOUSES
5 - OTHER NESHAP AFFECTED SOURCES

**I. RESTRICTIONS.**

No additional requirements exist except as provided in other sections of this permit including Section B (Title V General Requirements) and/or Section E (Source Group Restrictions).

II. TESTING REQUIREMENTS.

No additional testing requirements exist except as provided in other sections of this permit including Section B (Title V General Requirements) and/or Section E (Source Group Restrictions).

III. MONITORING REQUIREMENTS.

No additional monitoring requirements exist except as provided in other sections of this permit including Section B (Title V General Requirements) and/or Section E (Source Group Restrictions).

IV. RECORDKEEPING REQUIREMENTS.

No additional record keeping requirements exist except as provided in other sections of this permit including Section B (Title V General Requirements) and/or Section E (Source Group Restrictions).

V. REPORTING REQUIREMENTS.

No additional reporting requirements exist except as provided in other sections of this permit including Section B (Title V General Requirements) and/or Section E (Source Group Restrictions).

VI. WORK PRACTICE REQUIREMENTS.

No additional work practice requirements exist except as provided in other sections of this permit including Section B (Title V General Requirements) and/or Section E (Source Group Restrictions).

VII. ADDITIONAL REQUIREMENTS.

No additional requirements exist except as provided in other sections of this permit including Section B (Title V General Requirements) and/or Section E (Source Group Restrictions).

*** Permit Shield in Effect. ***

**SECTION D. Source Level Requirements**

Source ID: 213

Source Name: SOUTH PACKER

Source Capacity/Throughput: 15.000 Tons/HR CEMENT

Conditions for this source occur in the following groups: 1 - SOURCES WITH BAGHOUSES
5 - OTHER NESHAP AFFECTED SOURCES

**I. RESTRICTIONS.**

No additional requirements exist except as provided in other sections of this permit including Section B (Title V General Requirements) and/or Section E (Source Group Restrictions).

II. TESTING REQUIREMENTS.

No additional testing requirements exist except as provided in other sections of this permit including Section B (Title V General Requirements) and/or Section E (Source Group Restrictions).

III. MONITORING REQUIREMENTS.

No additional monitoring requirements exist except as provided in other sections of this permit including Section B (Title V General Requirements) and/or Section E (Source Group Restrictions).

IV. RECORDKEEPING REQUIREMENTS.

No additional record keeping requirements exist except as provided in other sections of this permit including Section B (Title V General Requirements) and/or Section E (Source Group Restrictions).

V. REPORTING REQUIREMENTS.

No additional reporting requirements exist except as provided in other sections of this permit including Section B (Title V General Requirements) and/or Section E (Source Group Restrictions).

VI. WORK PRACTICE REQUIREMENTS.

No additional work practice requirements exist except as provided in other sections of this permit including Section B (Title V General Requirements) and/or Section E (Source Group Restrictions).

VII. ADDITIONAL REQUIREMENTS.

No additional requirements exist except as provided in other sections of this permit including Section B (Title V General Requirements) and/or Section E (Source Group Restrictions).

*** Permit Shield in Effect. ***

**SECTION D. Source Level Requirements**

Source ID: 214

Source Name: NORTH PACKER

Source Capacity/Throughput: 8.000 Tons/HR CEMENT

Conditions for this source occur in the following groups: 1 - SOURCES WITH BAGHOUSES
5 - OTHER NESHAP AFFECTED SOURCES

**I. RESTRICTIONS.**

No additional requirements exist except as provided in other sections of this permit including Section B (Title V General Requirements) and/or Section E (Source Group Restrictions).

II. TESTING REQUIREMENTS.

No additional testing requirements exist except as provided in other sections of this permit including Section B (Title V General Requirements) and/or Section E (Source Group Restrictions).

III. MONITORING REQUIREMENTS.

No additional monitoring requirements exist except as provided in other sections of this permit including Section B (Title V General Requirements) and/or Section E (Source Group Restrictions).

IV. RECORDKEEPING REQUIREMENTS.

No additional record keeping requirements exist except as provided in other sections of this permit including Section B (Title V General Requirements) and/or Section E (Source Group Restrictions).

V. REPORTING REQUIREMENTS.

No additional reporting requirements exist except as provided in other sections of this permit including Section B (Title V General Requirements) and/or Section E (Source Group Restrictions).

VI. WORK PRACTICE REQUIREMENTS.

No additional work practice requirements exist except as provided in other sections of this permit including Section B (Title V General Requirements) and/or Section E (Source Group Restrictions).

VII. ADDITIONAL REQUIREMENTS.

No additional requirements exist except as provided in other sections of this permit including Section B (Title V General Requirements) and/or Section E (Source Group Restrictions).

*** Permit Shield in Effect. ***

**SECTION D. Source Level Requirements**

Source ID: 215

Source Name: MASONRY PACKER

Source Capacity/Throughput: 12.000 Tons/HR CEMENT

Conditions for this source occur in the following groups: 1 - SOURCES WITH BAGHOUSES
5 - OTHER NESHAP AFFECTED SOURCES

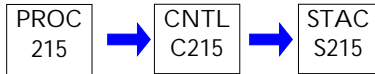
**I. RESTRICTIONS.**

No additional requirements exist except as provided in other sections of this permit including Section B (Title V General Requirements) and/or Section E (Source Group Restrictions).

II. TESTING REQUIREMENTS.

No additional testing requirements exist except as provided in other sections of this permit including Section B (Title V General Requirements) and/or Section E (Source Group Restrictions).

III. MONITORING REQUIREMENTS.

No additional monitoring requirements exist except as provided in other sections of this permit including Section B (Title V General Requirements) and/or Section E (Source Group Restrictions).

IV. RECORDKEEPING REQUIREMENTS.

No additional record keeping requirements exist except as provided in other sections of this permit including Section B (Title V General Requirements) and/or Section E (Source Group Restrictions).

V. REPORTING REQUIREMENTS.

No additional reporting requirements exist except as provided in other sections of this permit including Section B (Title V General Requirements) and/or Section E (Source Group Restrictions).

VI. WORK PRACTICE REQUIREMENTS.

No additional work practice requirements exist except as provided in other sections of this permit including Section B (Title V General Requirements) and/or Section E (Source Group Restrictions).

VII. ADDITIONAL REQUIREMENTS.

No additional requirements exist except as provided in other sections of this permit including Section B (Title V General Requirements) and/or Section E (Source Group Restrictions).

*** Permit Shield in Effect. ***

**SECTION D. Source Level Requirements**

Source ID: 216

Source Name: EAST/WEST TRUCK LOADING

Source Capacity/Throughput: 76.000 Tons/HR CEMENT

Conditions for this source occur in the following groups: 1 - SOURCES WITH BAGHOUSES
5 - OTHER NESHAP AFFECTED SOURCES

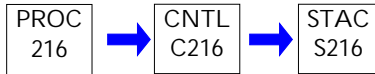
**I. RESTRICTIONS.**

No additional requirements exist except as provided in other sections of this permit including Section B (Title V General Requirements) and/or Section E (Source Group Restrictions).

II. TESTING REQUIREMENTS.

No additional testing requirements exist except as provided in other sections of this permit including Section B (Title V General Requirements) and/or Section E (Source Group Restrictions).

III. MONITORING REQUIREMENTS.

No additional monitoring requirements exist except as provided in other sections of this permit including Section B (Title V General Requirements) and/or Section E (Source Group Restrictions).

IV. RECORDKEEPING REQUIREMENTS.

No additional record keeping requirements exist except as provided in other sections of this permit including Section B (Title V General Requirements) and/or Section E (Source Group Restrictions).

V. REPORTING REQUIREMENTS.

No additional reporting requirements exist except as provided in other sections of this permit including Section B (Title V General Requirements) and/or Section E (Source Group Restrictions).

VI. WORK PRACTICE REQUIREMENTS.

No additional work practice requirements exist except as provided in other sections of this permit including Section B (Title V General Requirements) and/or Section E (Source Group Restrictions).

VII. ADDITIONAL REQUIREMENTS.

No additional requirements exist except as provided in other sections of this permit including Section B (Title V General Requirements) and/or Section E (Source Group Restrictions).

*** Permit Shield in Effect. ***

**SECTION D. Source Level Requirements**

Source ID: 217

Source Name: NEW TRUCK LOADING

Source Capacity/Throughput: 12.000 Tons/HR CEMENT

Conditions for this source occur in the following groups: 1 - SOURCES WITH BAGHOUSES
5 - OTHER NESHAP AFFECTED SOURCES

**I. RESTRICTIONS.**

No additional requirements exist except as provided in other sections of this permit including Section B (Title V General Requirements) and/or Section E (Source Group Restrictions).

II. TESTING REQUIREMENTS.

No additional testing requirements exist except as provided in other sections of this permit including Section B (Title V General Requirements) and/or Section E (Source Group Restrictions).

III. MONITORING REQUIREMENTS.

No additional monitoring requirements exist except as provided in other sections of this permit including Section B (Title V General Requirements) and/or Section E (Source Group Restrictions).

IV. RECORDKEEPING REQUIREMENTS.

No additional record keeping requirements exist except as provided in other sections of this permit including Section B (Title V General Requirements) and/or Section E (Source Group Restrictions).

V. REPORTING REQUIREMENTS.

No additional reporting requirements exist except as provided in other sections of this permit including Section B (Title V General Requirements) and/or Section E (Source Group Restrictions).

VI. WORK PRACTICE REQUIREMENTS.

No additional work practice requirements exist except as provided in other sections of this permit including Section B (Title V General Requirements) and/or Section E (Source Group Restrictions).

VII. ADDITIONAL REQUIREMENTS.

No additional requirements exist except as provided in other sections of this permit including Section B (Title V General Requirements) and/or Section E (Source Group Restrictions).

*** Permit Shield in Effect. ***

**SECTION D. Source Level Requirements**

Source ID: 218

Source Name: RAILCAR LOADING

Source Capacity/Throughput: 9.000 Tons/HR CEMENT

Conditions for this source occur in the following groups: 1 - SOURCES WITH BAGHOUSES
5 - OTHER NESHAP AFFECTED SOURCES

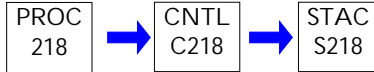
**I. RESTRICTIONS.**

No additional requirements exist except as provided in other sections of this permit including Section B (Title V General Requirements) and/or Section E (Source Group Restrictions).

II. TESTING REQUIREMENTS.

No additional testing requirements exist except as provided in other sections of this permit including Section B (Title V General Requirements) and/or Section E (Source Group Restrictions).

III. MONITORING REQUIREMENTS.

No additional monitoring requirements exist except as provided in other sections of this permit including Section B (Title V General Requirements) and/or Section E (Source Group Restrictions).

IV. RECORDKEEPING REQUIREMENTS.

No additional record keeping requirements exist except as provided in other sections of this permit including Section B (Title V General Requirements) and/or Section E (Source Group Restrictions).

V. REPORTING REQUIREMENTS.

No additional reporting requirements exist except as provided in other sections of this permit including Section B (Title V General Requirements) and/or Section E (Source Group Restrictions).

VI. WORK PRACTICE REQUIREMENTS.

No additional work practice requirements exist except as provided in other sections of this permit including Section B (Title V General Requirements) and/or Section E (Source Group Restrictions).

VII. ADDITIONAL REQUIREMENTS.

No additional requirements exist except as provided in other sections of this permit including Section B (Title V General Requirements) and/or Section E (Source Group Restrictions).

*** Permit Shield in Effect. ***

**SECTION D. Source Level Requirements**

Source ID: 220

Source Name: 3103 BELT & 3104 BELT

Source Capacity/Throughput: 810.000 Tons/HR CLINKER

Conditions for this source occur in the following groups: 1C - CLINKER TRANSFER SYSTEM B.H. (NEW)
5 - OTHER NESHAP AFFECTED SOURCES

**I. RESTRICTIONS.**

No additional requirements exist except as provided in other sections of this permit including Section B (Title V General Requirements) and/or Section E (Source Group Restrictions).

II. TESTING REQUIREMENTS.

No additional testing requirements exist except as provided in other sections of this permit including Section B (Title V General Requirements) and/or Section E (Source Group Restrictions).

III. MONITORING REQUIREMENTS.

No additional monitoring requirements exist except as provided in other sections of this permit including Section B (Title V General Requirements) and/or Section E (Source Group Restrictions).

IV. RECORDKEEPING REQUIREMENTS.

No additional record keeping requirements exist except as provided in other sections of this permit including Section B (Title V General Requirements) and/or Section E (Source Group Restrictions).

V. REPORTING REQUIREMENTS.

No additional reporting requirements exist except as provided in other sections of this permit including Section B (Title V General Requirements) and/or Section E (Source Group Restrictions).

VI. WORK PRACTICE REQUIREMENTS.

No additional work practice requirements exist except as provided in other sections of this permit including Section B (Title V General Requirements) and/or Section E (Source Group Restrictions).

VII. ADDITIONAL REQUIREMENTS.

No additional requirements exist except as provided in other sections of this permit including Section B (Title V General Requirements) and/or Section E (Source Group Restrictions).

*** Permit Shield in Effect. ***

**SECTION D. Source Level Requirements**

Source ID: 221

Source Name: KILN DUST (EARTH PLUS) SILOS

Source Capacity/Throughput:	50.000 Tons/HR	CLINKER DUST
	1.000 Tons/HR	CLINKER DUST

Conditions for this source occur in the following groups: 1 - SOURCES WITH BAGHOUSES
5 - OTHER NESHAP AFFECTED SOURCES

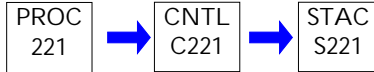
**I. RESTRICTIONS.**

No additional requirements exist except as provided in other sections of this permit including Section B (Title V General Requirements) and/or Section E (Source Group Restrictions).

II. TESTING REQUIREMENTS.

No additional testing requirements exist except as provided in other sections of this permit including Section B (Title V General Requirements) and/or Section E (Source Group Restrictions).

III. MONITORING REQUIREMENTS.

No additional monitoring requirements exist except as provided in other sections of this permit including Section B (Title V General Requirements) and/or Section E (Source Group Restrictions).

IV. RECORDKEEPING REQUIREMENTS.

No additional record keeping requirements exist except as provided in other sections of this permit including Section B (Title V General Requirements) and/or Section E (Source Group Restrictions).

V. REPORTING REQUIREMENTS.

No additional reporting requirements exist except as provided in other sections of this permit including Section B (Title V General Requirements) and/or Section E (Source Group Restrictions).

VI. WORK PRACTICE REQUIREMENTS.

No additional work practice requirements exist except as provided in other sections of this permit including Section B (Title V General Requirements) and/or Section E (Source Group Restrictions).

VII. ADDITIONAL REQUIREMENTS.

No additional requirements exist except as provided in other sections of this permit including Section B (Title V General Requirements) and/or Section E (Source Group Restrictions).

*** Permit Shield in Effect. ***

**SECTION D. Source Level Requirements**

Source ID: 222

Source Name: #2 FINISH MILL SEPARATOR

Source Capacity/Throughput: 90.000 Tons/HR CLINKER

Conditions for this source occur in the following groups: 1 - SOURCES WITH BAGHOUSES
4 - RAW AND FINISH MILL NESHAP REQ.

**I. RESTRICTIONS.**

No additional requirements exist except as provided in other sections of this permit including Section B (Title V General Requirements) and/or Section E (Source Group Restrictions).

II. TESTING REQUIREMENTS.

No additional testing requirements exist except as provided in other sections of this permit including Section B (Title V General Requirements) and/or Section E (Source Group Restrictions).

III. MONITORING REQUIREMENTS.

No additional monitoring requirements exist except as provided in other sections of this permit including Section B (Title V General Requirements) and/or Section E (Source Group Restrictions).

IV. RECORDKEEPING REQUIREMENTS.

No additional record keeping requirements exist except as provided in other sections of this permit including Section B (Title V General Requirements) and/or Section E (Source Group Restrictions).

V. REPORTING REQUIREMENTS.

No additional reporting requirements exist except as provided in other sections of this permit including Section B (Title V General Requirements) and/or Section E (Source Group Restrictions).

VI. WORK PRACTICE REQUIREMENTS.

No additional work practice requirements exist except as provided in other sections of this permit including Section B (Title V General Requirements) and/or Section E (Source Group Restrictions).

VII. ADDITIONAL REQUIREMENTS.

No additional requirements exist except as provided in other sections of this permit including Section B (Title V General Requirements) and/or Section E (Source Group Restrictions).

*** Permit Shield in Effect. ***

**SECTION D. Source Level Requirements**

Source ID: 223

Source Name: #1 CLINKER COOLER

Source Capacity/Throughput:	27.000 Tons/HR	CLINKER
	40.000 Tons/HR	CLINKER
	27.000 Tons/HR	CLINKER

Conditions for this source occur in the following groups: 3 - CLINKER COOLERS W/ NESHAP REQ.

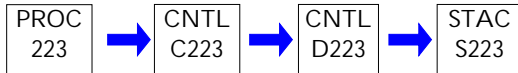
**I. RESTRICTIONS.**

No additional requirements exist except as provided in other sections of this permit including Section B (Title V General Requirements) and/or Section E (Source Group Restrictions).

II. TESTING REQUIREMENTS.

No additional testing requirements exist except as provided in other sections of this permit including Section B (Title V General Requirements) and/or Section E (Source Group Restrictions).

III. MONITORING REQUIREMENTS.

No additional monitoring requirements exist except as provided in other sections of this permit including Section B (Title V General Requirements) and/or Section E (Source Group Restrictions).

IV. RECORDKEEPING REQUIREMENTS.

No additional record keeping requirements exist except as provided in other sections of this permit including Section B (Title V General Requirements) and/or Section E (Source Group Restrictions).

V. REPORTING REQUIREMENTS.

No additional reporting requirements exist except as provided in other sections of this permit including Section B (Title V General Requirements) and/or Section E (Source Group Restrictions).

VI. WORK PRACTICE REQUIREMENTS.

No additional work practice requirements exist except as provided in other sections of this permit including Section B (Title V General Requirements) and/or Section E (Source Group Restrictions).

VII. ADDITIONAL REQUIREMENTS.

No additional requirements exist except as provided in other sections of this permit including Section B (Title V General Requirements) and/or Section E (Source Group Restrictions).

*** Permit Shield in Effect. ***

**SECTION D. Source Level Requirements**

Source ID: 224

Source Name: #2 CLINKER COOLER

Source Capacity/Throughput:	27.000 Tons/HR	CLINKER
	40.000 Tons/HR	CLINKER
	27.000 Tons/HR	CLINKER

Conditions for this source occur in the following groups: 3 - CLINKER COOLERS W/ NESHAP REQ.

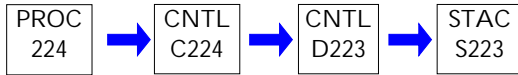
**I. RESTRICTIONS.**

No additional requirements exist except as provided in other sections of this permit including Section B (Title V General Requirements) and/or Section E (Source Group Restrictions).

II. TESTING REQUIREMENTS.

No additional testing requirements exist except as provided in other sections of this permit including Section B (Title V General Requirements) and/or Section E (Source Group Restrictions).

III. MONITORING REQUIREMENTS.

No additional monitoring requirements exist except as provided in other sections of this permit including Section B (Title V General Requirements) and/or Section E (Source Group Restrictions).

IV. RECORDKEEPING REQUIREMENTS.

No additional record keeping requirements exist except as provided in other sections of this permit including Section B (Title V General Requirements) and/or Section E (Source Group Restrictions).

V. REPORTING REQUIREMENTS.

No additional reporting requirements exist except as provided in other sections of this permit including Section B (Title V General Requirements) and/or Section E (Source Group Restrictions).

VI. WORK PRACTICE REQUIREMENTS.

No additional work practice requirements exist except as provided in other sections of this permit including Section B (Title V General Requirements) and/or Section E (Source Group Restrictions).

VII. ADDITIONAL REQUIREMENTS.

No additional requirements exist except as provided in other sections of this permit including Section B (Title V General Requirements) and/or Section E (Source Group Restrictions).

*** Permit Shield in Effect. ***

**SECTION D. Source Level Requirements**

Source ID: 225

Source Name: #3 CLINKER COOLER

Source Capacity/Throughput:	32.000 Tons/HR	CLINKER
	40.000 Tons/HR	CLINKER
	32.000 Tons/HR	CLINKER

Conditions for this source occur in the following groups: 3 - CLINKER COOLERS W/ NESHAP REQ.

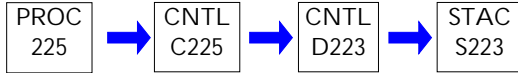
**I. RESTRICTIONS.**

No additional requirements exist except as provided in other sections of this permit including Section B (Title V General Requirements) and/or Section E (Source Group Restrictions).

II. TESTING REQUIREMENTS.

No additional testing requirements exist except as provided in other sections of this permit including Section B (Title V General Requirements) and/or Section E (Source Group Restrictions).

III. MONITORING REQUIREMENTS.

No additional monitoring requirements exist except as provided in other sections of this permit including Section B (Title V General Requirements) and/or Section E (Source Group Restrictions).

IV. RECORDKEEPING REQUIREMENTS.

No additional record keeping requirements exist except as provided in other sections of this permit including Section B (Title V General Requirements) and/or Section E (Source Group Restrictions).

V. REPORTING REQUIREMENTS.

No additional reporting requirements exist except as provided in other sections of this permit including Section B (Title V General Requirements) and/or Section E (Source Group Restrictions).

VI. WORK PRACTICE REQUIREMENTS.

No additional work practice requirements exist except as provided in other sections of this permit including Section B (Title V General Requirements) and/or Section E (Source Group Restrictions).

VII. ADDITIONAL REQUIREMENTS.

No additional requirements exist except as provided in other sections of this permit including Section B (Title V General Requirements) and/or Section E (Source Group Restrictions).

*** Permit Shield in Effect. ***

SECTION D. Source Level Requirements

Source ID: 226

Source Name: #1 KILN

Source Capacity/Throughput:	1.500 Tons/HR	BIOMASS
	27.000 Tons/HR	CLINKER
	6.000 Tons/HR	COAL
	250.000 Gal/HR	#2 FUEL OIL
	6.000 Tons/HR	SPENT ACTIVATED CARBON
	3.600 Tons/HR	VEXOR NON HAZARDOUS ENC

Conditions for this source occur in the following groups: 2 - CEMENT KILNS W/NESHAP REQ.

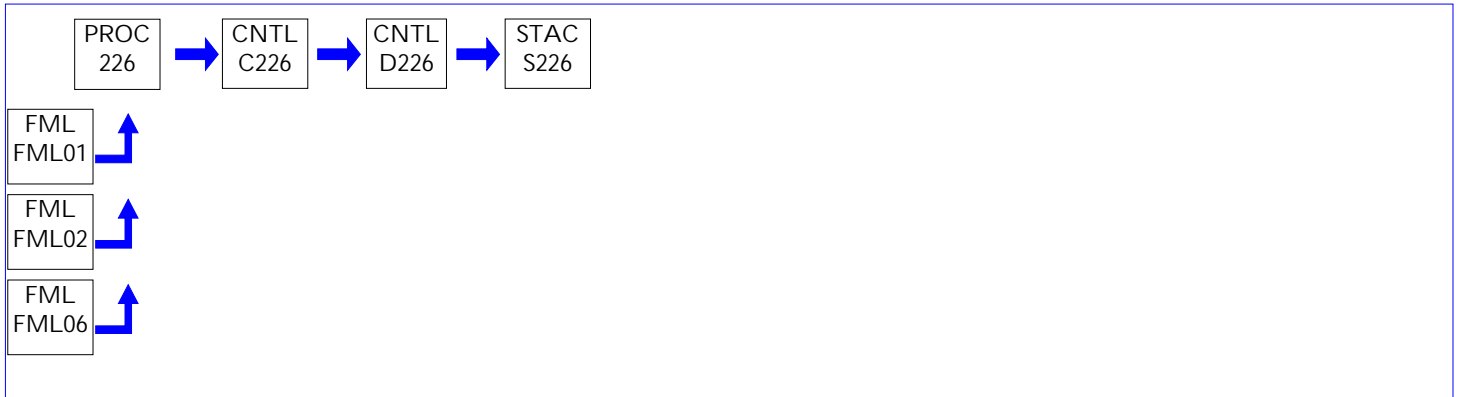
**I. RESTRICTIONS.**

No additional requirements exist except as provided in other sections of this permit including Section B (Title V General Requirements) and/or Section E (Source Group Restrictions).

II. TESTING REQUIREMENTS.

No additional testing requirements exist except as provided in other sections of this permit including Section B (Title V General Requirements) and/or Section E (Source Group Restrictions).

III. MONITORING REQUIREMENTS.

No additional monitoring requirements exist except as provided in other sections of this permit including Section B (Title V General Requirements) and/or Section E (Source Group Restrictions).

IV. RECORDKEEPING REQUIREMENTS.

No additional record keeping requirements exist except as provided in other sections of this permit including Section B (Title V General Requirements) and/or Section E (Source Group Restrictions).

V. REPORTING REQUIREMENTS.

No additional reporting requirements exist except as provided in other sections of this permit including Section B (Title V General Requirements) and/or Section E (Source Group Restrictions).

VI. WORK PRACTICE REQUIREMENTS.

No additional work practice requirements exist except as provided in other sections of this permit including Section B (Title V General Requirements) and/or Section E (Source Group Restrictions).



SECTION D. Source Level Requirements

VII. ADDITIONAL REQUIREMENTS.

No additional requirements exist except as provided in other sections of this permit including Section B (Title V General Requirements) and/or Section E (Source Group Restrictions).

*** Permit Shield in Effect. ***

**SECTION D. Source Level Requirements**

Source ID: 227

Source Name: #2 KILN

Source Capacity/Throughput:	1.500 Tons/HR	BIOMASS
	27.000 Tons/HR	CLINKER
	6.000 Tons/HR	COAL
	250.000 Gal/HR	#2 FUEL OIL
	6.000 Tons/HR	SPENT ACTIVATED CARBON
	3.600 Tons/HR	VEXOR NON HAZARDOUS ENC

Conditions for this source occur in the following groups: 2 - CEMENT KILNS W/NESHAP REQ.

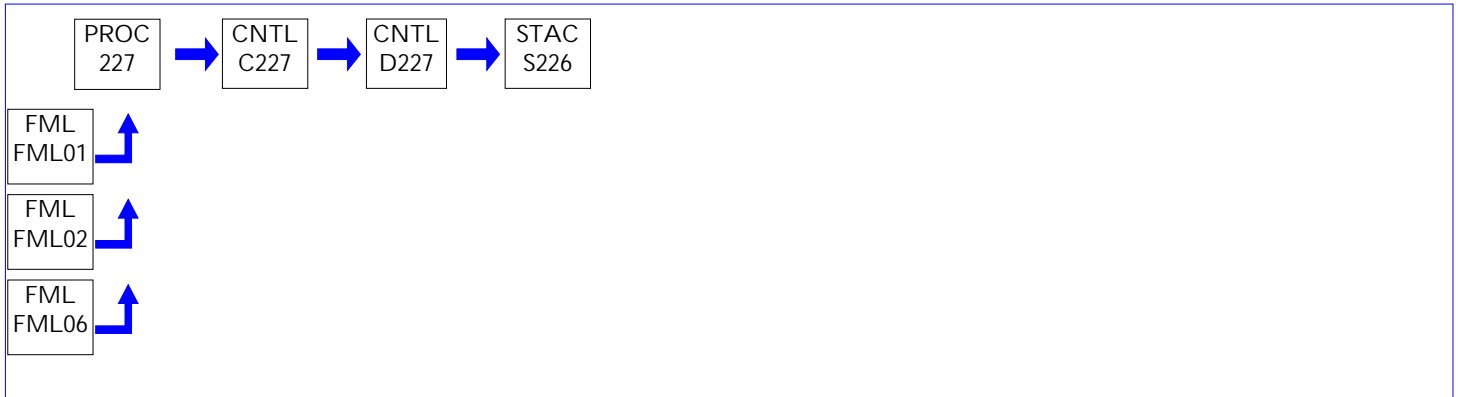
**I. RESTRICTIONS.**

No additional requirements exist except as provided in other sections of this permit including Section B (Title V General Requirements) and/or Section E (Source Group Restrictions).

II. TESTING REQUIREMENTS.

No additional testing requirements exist except as provided in other sections of this permit including Section B (Title V General Requirements) and/or Section E (Source Group Restrictions).

III. MONITORING REQUIREMENTS.

No additional monitoring requirements exist except as provided in other sections of this permit including Section B (Title V General Requirements) and/or Section E (Source Group Restrictions).

IV. RECORDKEEPING REQUIREMENTS.

No additional record keeping requirements exist except as provided in other sections of this permit including Section B (Title V General Requirements) and/or Section E (Source Group Restrictions).

V. REPORTING REQUIREMENTS.

No additional reporting requirements exist except as provided in other sections of this permit including Section B (Title V General Requirements) and/or Section E (Source Group Restrictions).

VI. WORK PRACTICE REQUIREMENTS.

No additional work practice requirements exist except as provided in other sections of this permit including Section B (Title V General Requirements) and/or Section E (Source Group Restrictions).



SECTION D. Source Level Requirements

VII. ADDITIONAL REQUIREMENTS.

No additional requirements exist except as provided in other sections of this permit including Section B (Title V General Requirements) and/or Section E (Source Group Restrictions).

*** Permit Shield in Effect. ***

SECTION D. Source Level Requirements

Source ID: 228	Source Name: #3 KILN		
	Source Capacity/Throughput:	1.500 Tons/HR	BIOMASS
		32.000 Tons/HR	CLINKER
		6.000 Tons/HR	COAL
		275.000 Gal/HR	#2 FUEL OIL
		6.000 Tons/HR	SPENT ACTIVATED CARBON
		3.600 Tons/HR	VEXOR NON HAZARDOUS ENC

Conditions for this source occur in the following groups: 2 - CEMENT KILNS W/NESHAP REQ.



I. RESTRICTIONS.

No additional requirements exist except as provided in other sections of this permit including Section B (Title V General Requirements) and/or Section E (Source Group Restrictions).

II. TESTING REQUIREMENTS.

No additional testing requirements exist except as provided in other sections of this permit including Section B (Title V General Requirements) and/or Section E (Source Group Restrictions).

III. MONITORING REQUIREMENTS.

No additional monitoring requirements exist except as provided in other sections of this permit including Section B (Title V General Requirements) and/or Section E (Source Group Restrictions).

IV. RECORDKEEPING REQUIREMENTS.

No additional record keeping requirements exist except as provided in other sections of this permit including Section B (Title V General Requirements) and/or Section E (Source Group Restrictions).

V. REPORTING REQUIREMENTS.

No additional reporting requirements exist except as provided in other sections of this permit including Section B (Title V General Requirements) and/or Section E (Source Group Restrictions).

VI. WORK PRACTICE REQUIREMENTS.

No additional work practice requirements exist except as provided in other sections of this permit including Section B (Title V General Requirements) and/or Section E (Source Group Restrictions).



SECTION D. Source Level Requirements

VII. ADDITIONAL REQUIREMENTS.

No additional requirements exist except as provided in other sections of this permit including Section B (Title V General Requirements) and/or Section E (Source Group Restrictions).

*** Permit Shield in Effect. ***

**SECTION D. Source Level Requirements**

Source ID: 229

Source Name: #1 KILN AUXILLIARY MOTOR

Source Capacity/Throughput:

1.000 Gal/HR

DIESEL

Conditions for this source occur in the following groups: 7 - KILN AUXILARY MOTORS

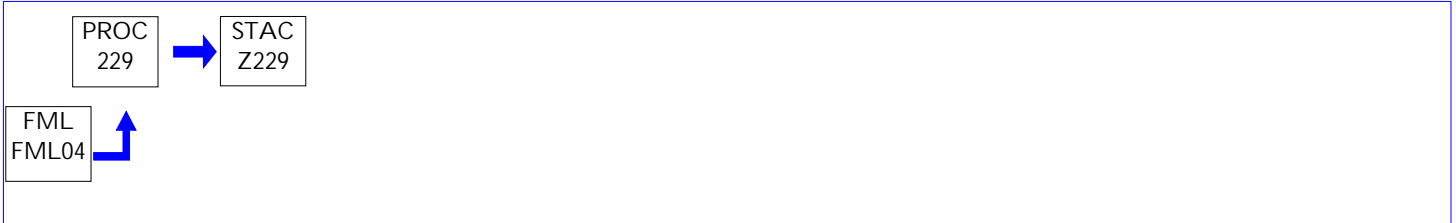
**I. RESTRICTIONS.**

No additional requirements exist except as provided in other sections of this permit including Section B (Title V General Requirements) and/or Section E (Source Group Restrictions).

II. TESTING REQUIREMENTS.

No additional testing requirements exist except as provided in other sections of this permit including Section B (Title V General Requirements) and/or Section E (Source Group Restrictions).

III. MONITORING REQUIREMENTS.

No additional monitoring requirements exist except as provided in other sections of this permit including Section B (Title V General Requirements) and/or Section E (Source Group Restrictions).

IV. RECORDKEEPING REQUIREMENTS.

No additional record keeping requirements exist except as provided in other sections of this permit including Section B (Title V General Requirements) and/or Section E (Source Group Restrictions).

V. REPORTING REQUIREMENTS.

No additional reporting requirements exist except as provided in other sections of this permit including Section B (Title V General Requirements) and/or Section E (Source Group Restrictions).

VI. WORK PRACTICE REQUIREMENTS.

No additional work practice requirements exist except as provided in other sections of this permit including Section B (Title V General Requirements) and/or Section E (Source Group Restrictions).

VII. ADDITIONAL REQUIREMENTS.

No additional requirements exist except as provided in other sections of this permit including Section B (Title V General Requirements) and/or Section E (Source Group Restrictions).

*** Permit Shield in Effect. ***

**SECTION D. Source Level Requirements**

Source ID: 230

Source Name: #2 KILN AUXILLIARY MOTOR

Source Capacity/Throughput:

1.000 Gal/HR

DIESEL

Conditions for this source occur in the following groups: 7 - KILN AUXILARY MOTORS

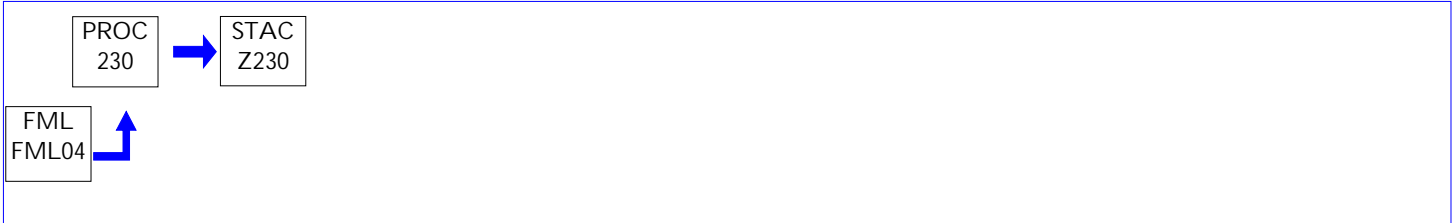
**I. RESTRICTIONS.**

No additional requirements exist except as provided in other sections of this permit including Section B (Title V General Requirements) and/or Section E (Source Group Restrictions).

II. TESTING REQUIREMENTS.

No additional testing requirements exist except as provided in other sections of this permit including Section B (Title V General Requirements) and/or Section E (Source Group Restrictions).

III. MONITORING REQUIREMENTS.

No additional monitoring requirements exist except as provided in other sections of this permit including Section B (Title V General Requirements) and/or Section E (Source Group Restrictions).

IV. RECORDKEEPING REQUIREMENTS.

No additional record keeping requirements exist except as provided in other sections of this permit including Section B (Title V General Requirements) and/or Section E (Source Group Restrictions).

V. REPORTING REQUIREMENTS.

No additional reporting requirements exist except as provided in other sections of this permit including Section B (Title V General Requirements) and/or Section E (Source Group Restrictions).

VI. WORK PRACTICE REQUIREMENTS.

No additional work practice requirements exist except as provided in other sections of this permit including Section B (Title V General Requirements) and/or Section E (Source Group Restrictions).

VII. ADDITIONAL REQUIREMENTS.

No additional requirements exist except as provided in other sections of this permit including Section B (Title V General Requirements) and/or Section E (Source Group Restrictions).

*** Permit Shield in Effect. ***

**SECTION D. Source Level Requirements**

Source ID: 231

Source Name: #3 KILN AUXILLIARY MOTOR

Source Capacity/Throughput:

1.000 Gal/HR

DIESEL

Conditions for this source occur in the following groups: 7 - KILN AUXILARY MOTORS

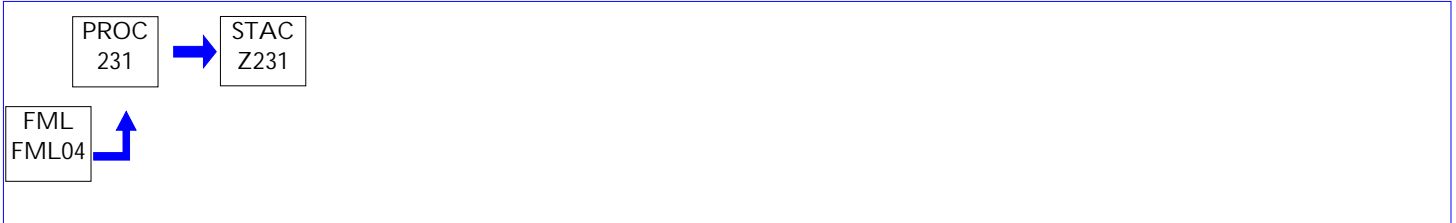
**I. RESTRICTIONS.**

No additional requirements exist except as provided in other sections of this permit including Section B (Title V General Requirements) and/or Section E (Source Group Restrictions).

II. TESTING REQUIREMENTS.

No additional testing requirements exist except as provided in other sections of this permit including Section B (Title V General Requirements) and/or Section E (Source Group Restrictions).

III. MONITORING REQUIREMENTS.

No additional monitoring requirements exist except as provided in other sections of this permit including Section B (Title V General Requirements) and/or Section E (Source Group Restrictions).

IV. RECORDKEEPING REQUIREMENTS.

No additional record keeping requirements exist except as provided in other sections of this permit including Section B (Title V General Requirements) and/or Section E (Source Group Restrictions).

V. REPORTING REQUIREMENTS.

No additional reporting requirements exist except as provided in other sections of this permit including Section B (Title V General Requirements) and/or Section E (Source Group Restrictions).

VI. WORK PRACTICE REQUIREMENTS.

No additional work practice requirements exist except as provided in other sections of this permit including Section B (Title V General Requirements) and/or Section E (Source Group Restrictions).

VII. ADDITIONAL REQUIREMENTS.

No additional requirements exist except as provided in other sections of this permit including Section B (Title V General Requirements) and/or Section E (Source Group Restrictions).

*** Permit Shield in Effect. ***

**SECTION D. Source Level Requirements**

Source ID: 232

Source Name: #1 RAW MILL FURNACE

Source Capacity/Throughput:

0.125 Tons/HR

BITUMINOUS

Conditions for this source occur in the following groups: 6 - RAW MATERIAL DRYERS W/NESHAP REQ.

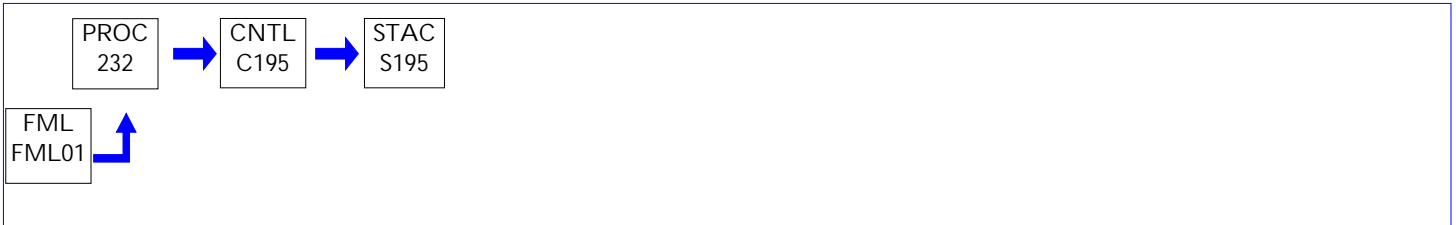
**I. RESTRICTIONS.**

No additional requirements exist except as provided in other sections of this permit including Section B (Title V General Requirements) and/or Section E (Source Group Restrictions).

II. TESTING REQUIREMENTS.

No additional testing requirements exist except as provided in other sections of this permit including Section B (Title V General Requirements) and/or Section E (Source Group Restrictions).

III. MONITORING REQUIREMENTS.

No additional monitoring requirements exist except as provided in other sections of this permit including Section B (Title V General Requirements) and/or Section E (Source Group Restrictions).

IV. RECORDKEEPING REQUIREMENTS.

No additional record keeping requirements exist except as provided in other sections of this permit including Section B (Title V General Requirements) and/or Section E (Source Group Restrictions).

V. REPORTING REQUIREMENTS.

No additional reporting requirements exist except as provided in other sections of this permit including Section B (Title V General Requirements) and/or Section E (Source Group Restrictions).

VI. WORK PRACTICE REQUIREMENTS.

No additional work practice requirements exist except as provided in other sections of this permit including Section B (Title V General Requirements) and/or Section E (Source Group Restrictions).

VII. ADDITIONAL REQUIREMENTS.

No additional requirements exist except as provided in other sections of this permit including Section B (Title V General Requirements) and/or Section E (Source Group Restrictions).

*** Permit Shield in Effect. ***

**SECTION D. Source Level Requirements**

Source ID: 233

Source Name: #2 RAW MILL FURNACE

Source Capacity/Throughput:

0.125 Tons/HR

BITUMINOUS

Conditions for this source occur in the following groups: 6 - RAW MATERIAL DRYERS W/NESHAP REQ.

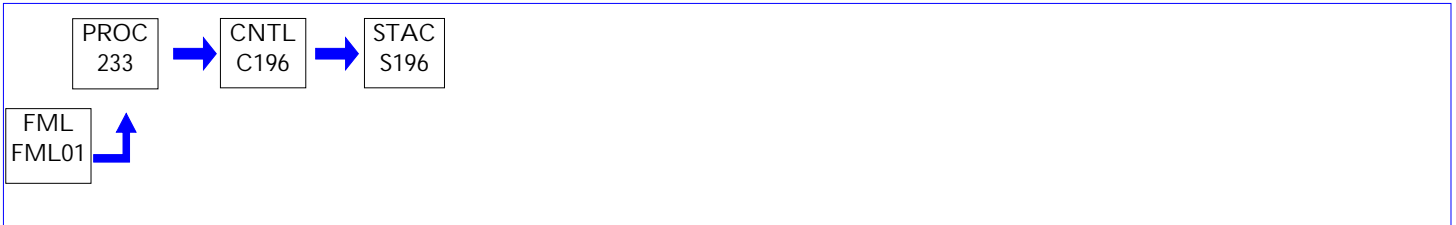
**I. RESTRICTIONS.**

No additional requirements exist except as provided in other sections of this permit including Section B (Title V General Requirements) and/or Section E (Source Group Restrictions).

II. TESTING REQUIREMENTS.

No additional testing requirements exist except as provided in other sections of this permit including Section B (Title V General Requirements) and/or Section E (Source Group Restrictions).

III. MONITORING REQUIREMENTS.

No additional monitoring requirements exist except as provided in other sections of this permit including Section B (Title V General Requirements) and/or Section E (Source Group Restrictions).

IV. RECORDKEEPING REQUIREMENTS.

No additional record keeping requirements exist except as provided in other sections of this permit including Section B (Title V General Requirements) and/or Section E (Source Group Restrictions).

V. REPORTING REQUIREMENTS.

No additional reporting requirements exist except as provided in other sections of this permit including Section B (Title V General Requirements) and/or Section E (Source Group Restrictions).

VI. WORK PRACTICE REQUIREMENTS.

No additional work practice requirements exist except as provided in other sections of this permit including Section B (Title V General Requirements) and/or Section E (Source Group Restrictions).

VII. ADDITIONAL REQUIREMENTS.

No additional requirements exist except as provided in other sections of this permit including Section B (Title V General Requirements) and/or Section E (Source Group Restrictions).

*** Permit Shield in Effect. ***

**SECTION D. Source Level Requirements**

Source ID: 234

Source Name: #1 FINISH MILL & SEPARATOR

Source Capacity/Throughput: 12.000 Tons/HR CEMENT

Conditions for this source occur in the following groups: 1 - SOURCES WITH BAGHOUSES
4 - RAW AND FINISH MILL NESHAP REQ.

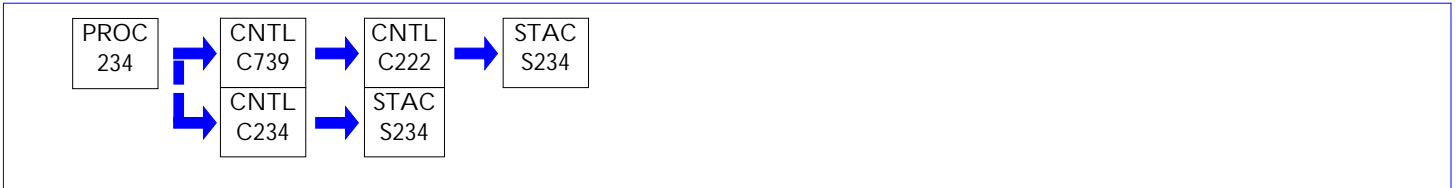
**I. RESTRICTIONS.**

No additional requirements exist except as provided in other sections of this permit including Section B (Title V General Requirements) and/or Section E (Source Group Restrictions).

II. TESTING REQUIREMENTS.

No additional testing requirements exist except as provided in other sections of this permit including Section B (Title V General Requirements) and/or Section E (Source Group Restrictions).

III. MONITORING REQUIREMENTS.

No additional monitoring requirements exist except as provided in other sections of this permit including Section B (Title V General Requirements) and/or Section E (Source Group Restrictions).

IV. RECORDKEEPING REQUIREMENTS.

No additional record keeping requirements exist except as provided in other sections of this permit including Section B (Title V General Requirements) and/or Section E (Source Group Restrictions).

V. REPORTING REQUIREMENTS.

No additional reporting requirements exist except as provided in other sections of this permit including Section B (Title V General Requirements) and/or Section E (Source Group Restrictions).

VI. WORK PRACTICE REQUIREMENTS.

No additional work practice requirements exist except as provided in other sections of this permit including Section B (Title V General Requirements) and/or Section E (Source Group Restrictions).

VII. ADDITIONAL REQUIREMENTS.

No additional requirements exist except as provided in other sections of this permit including Section B (Title V General Requirements) and/or Section E (Source Group Restrictions).

*** Permit Shield in Effect. ***

**SECTION D. Source Level Requirements**

Source ID: 235

Source Name: #2 FINISH MILL

Source Capacity/Throughput: 90.000 Tons/HR CEMENT

Conditions for this source occur in the following groups: 1 - SOURCES WITH BAGHOUSES
4 - RAW AND FINISH MILL NESHAP REQ.

**I. RESTRICTIONS.**

No additional requirements exist except as provided in other sections of this permit including Section B (Title V General Requirements) and/or Section E (Source Group Restrictions).

II. TESTING REQUIREMENTS.

No additional testing requirements exist except as provided in other sections of this permit including Section B (Title V General Requirements) and/or Section E (Source Group Restrictions).

III. MONITORING REQUIREMENTS.

No additional monitoring requirements exist except as provided in other sections of this permit including Section B (Title V General Requirements) and/or Section E (Source Group Restrictions).

IV. RECORDKEEPING REQUIREMENTS.

No additional record keeping requirements exist except as provided in other sections of this permit including Section B (Title V General Requirements) and/or Section E (Source Group Restrictions).

V. REPORTING REQUIREMENTS.

No additional reporting requirements exist except as provided in other sections of this permit including Section B (Title V General Requirements) and/or Section E (Source Group Restrictions).

VI. WORK PRACTICE REQUIREMENTS.

No additional work practice requirements exist except as provided in other sections of this permit including Section B (Title V General Requirements) and/or Section E (Source Group Restrictions).

VII. ADDITIONAL REQUIREMENTS.

No additional requirements exist except as provided in other sections of this permit including Section B (Title V General Requirements) and/or Section E (Source Group Restrictions).

*** Permit Shield in Effect. ***

**SECTION D. Source Level Requirements**

Source ID: 237

Source Name: UNLOAD TO SLAG PILE

Source Capacity/Throughput: 90.000 Tons/HR SLAG

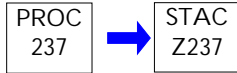
**I. RESTRICTIONS.**

No additional requirements exist except as provided in other sections of this permit including Section B (Title V General Requirements).

II. TESTING REQUIREMENTS.

No additional testing requirements exist except as provided in other sections of this permit including Section B (Title V General Requirements).

III. MONITORING REQUIREMENTS.

No additional monitoring requirements exist except as provided in other sections of this permit including Section B (Title V General Requirements).

IV. RECORDKEEPING REQUIREMENTS.

No additional record keeping requirements exist except as provided in other sections of this permit including Section B (Title V General Requirements).

V. REPORTING REQUIREMENTS.

No additional reporting requirements exist except as provided in other sections of this permit including Section B (Title V General Requirements).

VI. WORK PRACTICE REQUIREMENTS.

No additional work practice requirements exist except as provided in other sections of this permit including Section B (Title V General Requirements).

VII. ADDITIONAL REQUIREMENTS.

No additional requirements exist except as provided in other sections of this permit including Section B (Title V General Requirements).

*** Permit Shield in Effect. ***

**SECTION D. Source Level Requirements**

Source ID: 238

Source Name: SLAG PILE

Source Capacity/Throughput: 90.000 Tons/HR SLAG

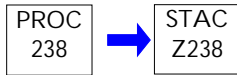
**I. RESTRICTIONS.**

No additional requirements exist except as provided in other sections of this permit including Section B (Title V General Requirements).

II. TESTING REQUIREMENTS.

No additional testing requirements exist except as provided in other sections of this permit including Section B (Title V General Requirements).

III. MONITORING REQUIREMENTS.

No additional monitoring requirements exist except as provided in other sections of this permit including Section B (Title V General Requirements).

IV. RECORDKEEPING REQUIREMENTS.

No additional record keeping requirements exist except as provided in other sections of this permit including Section B (Title V General Requirements).

V. REPORTING REQUIREMENTS.

No additional reporting requirements exist except as provided in other sections of this permit including Section B (Title V General Requirements).

VI. WORK PRACTICE REQUIREMENTS.

No additional work practice requirements exist except as provided in other sections of this permit including Section B (Title V General Requirements).

VII. ADDITIONAL REQUIREMENTS.

No additional requirements exist except as provided in other sections of this permit including Section B (Title V General Requirements).

*** Permit Shield in Effect. ***

**SECTION D. Source Level Requirements**

Source ID: 239

Source Name: REMOVE FROM SLAG PILE

Source Capacity/Throughput: 90.000 Tons/HR SLAG

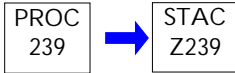
**I. RESTRICTIONS.**

No additional requirements exist except as provided in other sections of this permit including Section B (Title V General Requirements).

II. TESTING REQUIREMENTS.

No additional testing requirements exist except as provided in other sections of this permit including Section B (Title V General Requirements).

III. MONITORING REQUIREMENTS.

No additional monitoring requirements exist except as provided in other sections of this permit including Section B (Title V General Requirements).

IV. RECORDKEEPING REQUIREMENTS.

No additional record keeping requirements exist except as provided in other sections of this permit including Section B (Title V General Requirements).

V. REPORTING REQUIREMENTS.

No additional reporting requirements exist except as provided in other sections of this permit including Section B (Title V General Requirements).

VI. WORK PRACTICE REQUIREMENTS.

No additional work practice requirements exist except as provided in other sections of this permit including Section B (Title V General Requirements).

VII. ADDITIONAL REQUIREMENTS.

No additional requirements exist except as provided in other sections of this permit including Section B (Title V General Requirements).

*** Permit Shield in Effect. ***

**SECTION D. Source Level Requirements**

Source ID: 240

Source Name: UNLOAD FROM SLAG HOPPER

Source Capacity/Throughput: 90.000 Tons/HR SLAG

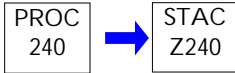
**I. RESTRICTIONS.****Throughput Restriction(s).**

001 [25 Pa. Code §127.12b]

Plan approval terms and conditions.

The maximum throughput for this slag system is based on design rate and shall not exceed 90 tons per hour, as measured by the weigh feeders. The weigh feeders are continuously measured and the information is fed to the Data Acquisition System.

[From Plan Approval 37-013F, Condition #006]

II. TESTING REQUIREMENTS.

No additional testing requirements exist except as provided in other sections of this permit including Section B (Title V General Requirements).

III. MONITORING REQUIREMENTS.

No additional monitoring requirements exist except as provided in other sections of this permit including Section B (Title V General Requirements).

IV. RECORDKEEPING REQUIREMENTS.

No additional record keeping requirements exist except as provided in other sections of this permit including Section B (Title V General Requirements).

V. REPORTING REQUIREMENTS.

No additional reporting requirements exist except as provided in other sections of this permit including Section B (Title V General Requirements).

VI. WORK PRACTICE REQUIREMENTS.

No additional work practice requirements exist except as provided in other sections of this permit including Section B (Title V General Requirements).

VII. ADDITIONAL REQUIREMENTS.

No additional requirements exist except as provided in other sections of this permit including Section B (Title V General Requirements).

*** Permit Shield in Effect. ***

**SECTION D. Source Level Requirements**

Source ID: 241

Source Name: SLAG HOPPER TO SLAG BELT 1A TRANSFER

Source Capacity/Throughput: 30.000 Tons/HR SLAG

Conditions for this source occur in the following groups: 5 - OTHER NESHAP AFFECTED SOURCES

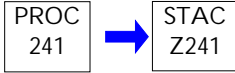
**I. RESTRICTIONS.**

No additional requirements exist except as provided in other sections of this permit including Section B (Title V General Requirements) and/or Section E (Source Group Restrictions).

II. TESTING REQUIREMENTS.

No additional testing requirements exist except as provided in other sections of this permit including Section B (Title V General Requirements) and/or Section E (Source Group Restrictions).

III. MONITORING REQUIREMENTS.

No additional monitoring requirements exist except as provided in other sections of this permit including Section B (Title V General Requirements) and/or Section E (Source Group Restrictions).

IV. RECORDKEEPING REQUIREMENTS.

No additional record keeping requirements exist except as provided in other sections of this permit including Section B (Title V General Requirements) and/or Section E (Source Group Restrictions).

V. REPORTING REQUIREMENTS.

No additional reporting requirements exist except as provided in other sections of this permit including Section B (Title V General Requirements) and/or Section E (Source Group Restrictions).

VI. WORK PRACTICE REQUIREMENTS.

No additional work practice requirements exist except as provided in other sections of this permit including Section B (Title V General Requirements) and/or Section E (Source Group Restrictions).

VII. ADDITIONAL REQUIREMENTS.

No additional requirements exist except as provided in other sections of this permit including Section B (Title V General Requirements) and/or Section E (Source Group Restrictions).

*** Permit Shield in Effect. ***

**SECTION D. Source Level Requirements**

Source ID: 242

Source Name: SLAG HOPPER TO SLAG BELT 2A TRANSFER

Source Capacity/Throughput: 30.000 Tons/HR SLAG

Conditions for this source occur in the following groups: 5 - OTHER NESHAP AFFECTED SOURCES

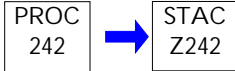
**I. RESTRICTIONS.**

No additional requirements exist except as provided in other sections of this permit including Section B (Title V General Requirements) and/or Section E (Source Group Restrictions).

II. TESTING REQUIREMENTS.

No additional testing requirements exist except as provided in other sections of this permit including Section B (Title V General Requirements) and/or Section E (Source Group Restrictions).

III. MONITORING REQUIREMENTS.

No additional monitoring requirements exist except as provided in other sections of this permit including Section B (Title V General Requirements) and/or Section E (Source Group Restrictions).

IV. RECORDKEEPING REQUIREMENTS.

No additional record keeping requirements exist except as provided in other sections of this permit including Section B (Title V General Requirements) and/or Section E (Source Group Restrictions).

V. REPORTING REQUIREMENTS.

No additional reporting requirements exist except as provided in other sections of this permit including Section B (Title V General Requirements) and/or Section E (Source Group Restrictions).

VI. WORK PRACTICE REQUIREMENTS.

No additional work practice requirements exist except as provided in other sections of this permit including Section B (Title V General Requirements) and/or Section E (Source Group Restrictions).

VII. ADDITIONAL REQUIREMENTS.

No additional requirements exist except as provided in other sections of this permit including Section B (Title V General Requirements) and/or Section E (Source Group Restrictions).

*** Permit Shield in Effect. ***

**SECTION D. Source Level Requirements**

Source ID: 243

Source Name: SLAG HOPPER TO SLAG BELT 3A TRANSFER

Source Capacity/Throughput: 30.000 Tons/HR SLAG

Conditions for this source occur in the following groups: 5 - OTHER NESHAP AFFECTED SOURCES

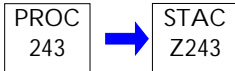
**I. RESTRICTIONS.**

No additional requirements exist except as provided in other sections of this permit including Section B (Title V General Requirements) and/or Section E (Source Group Restrictions).

II. TESTING REQUIREMENTS.

No additional testing requirements exist except as provided in other sections of this permit including Section B (Title V General Requirements) and/or Section E (Source Group Restrictions).

III. MONITORING REQUIREMENTS.

No additional monitoring requirements exist except as provided in other sections of this permit including Section B (Title V General Requirements) and/or Section E (Source Group Restrictions).

IV. RECORDKEEPING REQUIREMENTS.

No additional record keeping requirements exist except as provided in other sections of this permit including Section B (Title V General Requirements) and/or Section E (Source Group Restrictions).

V. REPORTING REQUIREMENTS.

No additional reporting requirements exist except as provided in other sections of this permit including Section B (Title V General Requirements) and/or Section E (Source Group Restrictions).

VI. WORK PRACTICE REQUIREMENTS.

No additional work practice requirements exist except as provided in other sections of this permit including Section B (Title V General Requirements) and/or Section E (Source Group Restrictions).

VII. ADDITIONAL REQUIREMENTS.

No additional requirements exist except as provided in other sections of this permit including Section B (Title V General Requirements) and/or Section E (Source Group Restrictions).

*** Permit Shield in Effect. ***

**SECTION D. Source Level Requirements**

Source ID: 244

Source Name: SLAG BELT 1A TO SLAG BELT 1B TRANSFER

Source Capacity/Throughput: 30.000 Tons/HR SLAG

Conditions for this source occur in the following groups: 5 - OTHER NESHAP AFFECTED SOURCES

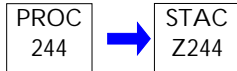
**I. RESTRICTIONS.**

No additional requirements exist except as provided in other sections of this permit including Section B (Title V General Requirements) and/or Section E (Source Group Restrictions).

II. TESTING REQUIREMENTS.

No additional testing requirements exist except as provided in other sections of this permit including Section B (Title V General Requirements) and/or Section E (Source Group Restrictions).

III. MONITORING REQUIREMENTS.

No additional monitoring requirements exist except as provided in other sections of this permit including Section B (Title V General Requirements) and/or Section E (Source Group Restrictions).

IV. RECORDKEEPING REQUIREMENTS.

No additional record keeping requirements exist except as provided in other sections of this permit including Section B (Title V General Requirements) and/or Section E (Source Group Restrictions).

V. REPORTING REQUIREMENTS.

No additional reporting requirements exist except as provided in other sections of this permit including Section B (Title V General Requirements) and/or Section E (Source Group Restrictions).

VI. WORK PRACTICE REQUIREMENTS.

No additional work practice requirements exist except as provided in other sections of this permit including Section B (Title V General Requirements) and/or Section E (Source Group Restrictions).

VII. ADDITIONAL REQUIREMENTS.

No additional requirements exist except as provided in other sections of this permit including Section B (Title V General Requirements) and/or Section E (Source Group Restrictions).

*** Permit Shield in Effect. ***

**SECTION D. Source Level Requirements**

Source ID: 245

Source Name: SLAG BELT 1B TO SLAG BELT 1C TRANSFER

Source Capacity/Throughput: 30.000 Tons/HR SLAG

Conditions for this source occur in the following groups: 5 - OTHER NESHAP AFFECTED SOURCES

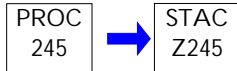
**I. RESTRICTIONS.**

No additional requirements exist except as provided in other sections of this permit including Section B (Title V General Requirements) and/or Section E (Source Group Restrictions).

II. TESTING REQUIREMENTS.

No additional testing requirements exist except as provided in other sections of this permit including Section B (Title V General Requirements) and/or Section E (Source Group Restrictions).

III. MONITORING REQUIREMENTS.

No additional monitoring requirements exist except as provided in other sections of this permit including Section B (Title V General Requirements) and/or Section E (Source Group Restrictions).

IV. RECORDKEEPING REQUIREMENTS.

No additional record keeping requirements exist except as provided in other sections of this permit including Section B (Title V General Requirements) and/or Section E (Source Group Restrictions).

V. REPORTING REQUIREMENTS.

No additional reporting requirements exist except as provided in other sections of this permit including Section B (Title V General Requirements) and/or Section E (Source Group Restrictions).

VI. WORK PRACTICE REQUIREMENTS.

No additional work practice requirements exist except as provided in other sections of this permit including Section B (Title V General Requirements) and/or Section E (Source Group Restrictions).

VII. ADDITIONAL REQUIREMENTS.

No additional requirements exist except as provided in other sections of this permit including Section B (Title V General Requirements) and/or Section E (Source Group Restrictions).

*** Permit Shield in Effect. ***

**SECTION D. Source Level Requirements**

Source ID: 246

Source Name: SLAG BELT 2A TO SLAG BELT 2B TRANSFER

Source Capacity/Throughput: 30.000 Tons/HR SLAG

Conditions for this source occur in the following groups: 5 - OTHER NESHAP AFFECTED SOURCES

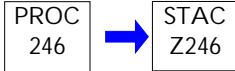
**I. RESTRICTIONS.**

No additional requirements exist except as provided in other sections of this permit including Section B (Title V General Requirements) and/or Section E (Source Group Restrictions).

II. TESTING REQUIREMENTS.

No additional testing requirements exist except as provided in other sections of this permit including Section B (Title V General Requirements) and/or Section E (Source Group Restrictions).

III. MONITORING REQUIREMENTS.

No additional monitoring requirements exist except as provided in other sections of this permit including Section B (Title V General Requirements) and/or Section E (Source Group Restrictions).

IV. RECORDKEEPING REQUIREMENTS.

No additional record keeping requirements exist except as provided in other sections of this permit including Section B (Title V General Requirements) and/or Section E (Source Group Restrictions).

V. REPORTING REQUIREMENTS.

No additional reporting requirements exist except as provided in other sections of this permit including Section B (Title V General Requirements) and/or Section E (Source Group Restrictions).

VI. WORK PRACTICE REQUIREMENTS.

No additional work practice requirements exist except as provided in other sections of this permit including Section B (Title V General Requirements) and/or Section E (Source Group Restrictions).

VII. ADDITIONAL REQUIREMENTS.

No additional requirements exist except as provided in other sections of this permit including Section B (Title V General Requirements) and/or Section E (Source Group Restrictions).

*** Permit Shield in Effect. ***

**SECTION D. Source Level Requirements**

Source ID: 247

Source Name: SLAG BELT 2B TO SLAG BELT 2C TRANSFER

Source Capacity/Throughput: 30.000 Tons/HR SLAG

Conditions for this source occur in the following groups: 5 - OTHER NESHAP AFFECTED SOURCES

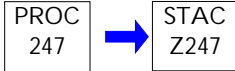
**I. RESTRICTIONS.**

No additional requirements exist except as provided in other sections of this permit including Section B (Title V General Requirements) and/or Section E (Source Group Restrictions).

II. TESTING REQUIREMENTS.

No additional testing requirements exist except as provided in other sections of this permit including Section B (Title V General Requirements) and/or Section E (Source Group Restrictions).

III. MONITORING REQUIREMENTS.

No additional monitoring requirements exist except as provided in other sections of this permit including Section B (Title V General Requirements) and/or Section E (Source Group Restrictions).

IV. RECORDKEEPING REQUIREMENTS.

No additional record keeping requirements exist except as provided in other sections of this permit including Section B (Title V General Requirements) and/or Section E (Source Group Restrictions).

V. REPORTING REQUIREMENTS.

No additional reporting requirements exist except as provided in other sections of this permit including Section B (Title V General Requirements) and/or Section E (Source Group Restrictions).

VI. WORK PRACTICE REQUIREMENTS.

No additional work practice requirements exist except as provided in other sections of this permit including Section B (Title V General Requirements) and/or Section E (Source Group Restrictions).

VII. ADDITIONAL REQUIREMENTS.

No additional requirements exist except as provided in other sections of this permit including Section B (Title V General Requirements) and/or Section E (Source Group Restrictions).

*** Permit Shield in Effect. ***

**SECTION D. Source Level Requirements**

Source ID: 248

Source Name: SLAG BELT 3A TO SLAG BELT 3B TRANSFER

Source Capacity/Throughput: 30.000 Tons/HR SLAG

Conditions for this source occur in the following groups: 5 - OTHER NESHAP AFFECTED SOURCES

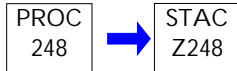
**I. RESTRICTIONS.**

No additional requirements exist except as provided in other sections of this permit including Section B (Title V General Requirements) and/or Section E (Source Group Restrictions).

II. TESTING REQUIREMENTS.

No additional testing requirements exist except as provided in other sections of this permit including Section B (Title V General Requirements) and/or Section E (Source Group Restrictions).

III. MONITORING REQUIREMENTS.

No additional monitoring requirements exist except as provided in other sections of this permit including Section B (Title V General Requirements) and/or Section E (Source Group Restrictions).

IV. RECORDKEEPING REQUIREMENTS.

No additional record keeping requirements exist except as provided in other sections of this permit including Section B (Title V General Requirements) and/or Section E (Source Group Restrictions).

V. REPORTING REQUIREMENTS.

No additional reporting requirements exist except as provided in other sections of this permit including Section B (Title V General Requirements) and/or Section E (Source Group Restrictions).

VI. WORK PRACTICE REQUIREMENTS.

No additional work practice requirements exist except as provided in other sections of this permit including Section B (Title V General Requirements) and/or Section E (Source Group Restrictions).

VII. ADDITIONAL REQUIREMENTS.

No additional requirements exist except as provided in other sections of this permit including Section B (Title V General Requirements) and/or Section E (Source Group Restrictions).

*** Permit Shield in Effect. ***

**SECTION D. Source Level Requirements**

Source ID: 249

Source Name: SLAG BELT 3B TO SLAG BELT 3C TRANSFER

Source Capacity/Throughput: 30.000 Tons/HR SLAG

Conditions for this source occur in the following groups: 5 - OTHER NESHAP AFFECTED SOURCES

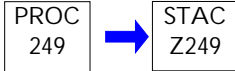
**I. RESTRICTIONS.**

No additional requirements exist except as provided in other sections of this permit including Section B (Title V General Requirements) and/or Section E (Source Group Restrictions).

II. TESTING REQUIREMENTS.

No additional testing requirements exist except as provided in other sections of this permit including Section B (Title V General Requirements) and/or Section E (Source Group Restrictions).

III. MONITORING REQUIREMENTS.

No additional monitoring requirements exist except as provided in other sections of this permit including Section B (Title V General Requirements) and/or Section E (Source Group Restrictions).

IV. RECORDKEEPING REQUIREMENTS.

No additional record keeping requirements exist except as provided in other sections of this permit including Section B (Title V General Requirements) and/or Section E (Source Group Restrictions).

V. REPORTING REQUIREMENTS.

No additional reporting requirements exist except as provided in other sections of this permit including Section B (Title V General Requirements) and/or Section E (Source Group Restrictions).

VI. WORK PRACTICE REQUIREMENTS.

No additional work practice requirements exist except as provided in other sections of this permit including Section B (Title V General Requirements) and/or Section E (Source Group Restrictions).

VII. ADDITIONAL REQUIREMENTS.

No additional requirements exist except as provided in other sections of this permit including Section B (Title V General Requirements) and/or Section E (Source Group Restrictions).

*** Permit Shield in Effect. ***

**SECTION E. Source Group Restrictions.**

Group Name: 1 - SOURCES WITH BAGHOUSES

Group Description:

Sources included in this group:

ID	Name
195	#1 RAW MILL & SEPARATOR
196	#2 RAW MILL & SEPARATOR
197	#3 RAW MILL & SEPARATOR
200	GRAVEL BED FILTER DUST SILO
201	KILN DUST (EARTH PLUS) TANK
203	CLINKER STORAGE BUILDING
204	CLINKER DOME AND TUNNEL
205	#1 & #2 KILN FEED ELEVATOR
206	#1 & #3 HOMOGENIZING SILOS
207	#5 HOMOGENIZING SILO
208	SURGE BIN
209	EAST CEMENT SILOS
210	WEST CEMENT SILOS
211	#1 - #4 CEMENT SILOS
212	MASONRY CEMENT SILO
213	SOUTH PACKER
214	NORTH PACKER
215	MASONRY PACKER
216	EAST/WEST TRUCK LOADING
217	NEW TRUCK LOADING
218	RAILCAR LOADING
221	KILN DUST (EARTH PLUS) SILOS
222	#2 FINISH MILL SEPARATOR
234	#1 FINISH MILL & SEPARATOR
235	#2 FINISH MILL

I. RESTRICTIONS.**Emission Restriction(s).**

001 [25 Pa. Code §123.13]

Processes

No person may permit the emission into the outdoor atmosphere of particulate matter from any process in a manner that the concentration of particulate matter in the effluent gas exceeds .04 grain per dry standard cubic foot, when the effluent gas volume is less than 150,000 dry standard cubic feet per minute.

II. TESTING REQUIREMENTS.

No additional testing requirements exist except as provided in other sections of this permit including Section B (Title V General Requirements).

III. MONITORING REQUIREMENTS.

No additional monitoring requirements exist except as provided in other sections of this permit including Section B (Title V General Requirements).



SECTION E. Source Group Restrictions.

IV. RECORDKEEPING REQUIREMENTS.

002 [25 Pa. Code §127.511]

Monitoring and related recordkeeping and reporting requirements.

The permittee shall maintain a log of all inspections of the control device associated with each source. The log shall, at a minimum, contain the dates of the inspections, any problems or defects observed during the inspection, the actions taken to correct the problem or defect, any routing maintenance performed, and the pressure drop across the control device.

V. REPORTING REQUIREMENTS.

No additional reporting requirements exist except as provided in other sections of this permit including Section B (Title V General Requirements).

VI. WORK PRACTICE REQUIREMENTS.

003 [25 Pa. Code §127.511]

Monitoring and related recordkeeping and reporting requirements.

- (a) The permittee shall conduct a preventive maintenance program for each control device that includes daily, monthly, and yearly inspections of the control device.
- (b) The permittee shall install, operate, and maintain a manometer or similar device to measure the pressure drop across the control device.
- (c) The permittee shall operate the control device at all times that the source is in operation.
- (d) The permittee shall maintain and operate the source and control device in accordance with good air pollution control practices.

VII. ADDITIONAL REQUIREMENTS.

No additional requirements exist except as provided in other sections of this permit including Section B (Title V General Requirements).

*** Permit Shield in Effect. ***

**SECTION E. Source Group Restrictions.**

Group Name: 1B - SOURCES WITH NEW BAGHOUSES

Group Description: Requirements from Plan Approval #37013D

Sources included in this group:

ID	Name
131	CLINKER BELT TO CLINKER SILO TRANSFER
150	#7 BELT TO CLINKER SILO TRANSFER

I. RESTRICTIONS.**Emission Restriction(s).**

001 [25 Pa. Code §127.12b]

[Plan approval terms and conditions.](#)

Particulate matter emissions from the source shall not exceed 0.02 grains per dry standard cubic foot (0.02 gr/dscf), of effluent air. [From Plan Approval No. PA37013D, Condition #5]

II. TESTING REQUIREMENTS.

No additional testing requirements exist except as provided in other sections of this permit including Section B (Title V General Requirements).

III. MONITORING REQUIREMENTS.

002 [25 Pa. Code §127.12b]

[Plan approval terms and conditions.](#)

(a) Daily opacity observations shall be made while the source is operational. Per USEPA Method 22, the daily opacity check will not require that the opacity of emissions be determined.

(b) The Department reserves the right to require stack testing of the baghouse in the event that excess opacity is observed from the baghouse or sources.

[From Plan Approval No. PA37013D, Condition #5]

IV. RECORDKEEPING REQUIREMENTS.

003 [25 Pa. Code §127.12b]

[Plan approval terms and conditions.](#)

The permittee shall maintain a record of the [Method 22] opacity observations. The record shall be maintained onsite for a minimum of five (5) years. [From Plan Approval No. PA37013D, Condition #5]

V. REPORTING REQUIREMENTS.

No additional reporting requirements exist except as provided in other sections of this permit including Section B (Title V General Requirements).

VI. WORK PRACTICE REQUIREMENTS.

004 [25 Pa. Code §127.12b]

[Plan approval terms and conditions.](#)

(a) The baghouse shall be equipped with a magnehelic gauge (or equivalent), to monitor pressure drop. [From Plan Approval No. PA37013D, Condition #6]

(b) A working pressure drop range shall be developed during startup and shakedown, and shall be maintained during all periods of operation. [From Plan Approval No. PA37013D, Condition #6]

(c) The facility shall maintain a minimum of 8 spare baghouse bags onsite, or shall have immediate access to replacement bags, in the event of bag failure. [From Plan Approval No. PA37013D, Cond. #7]

(d) The source shall not be operated when the baghouse is not operating. [From Plan Approval No. PA37013D, Cond. #7]

(e) Compliance with the particulate emission limit shall be shown by operation of the source and control device in accordance



SECTION E. Source Group Restrictions.

with the manufacturer's specifications, and in a manner consistent with good air pollution control practices. [From Plan Approval No. PA37013D, Condition #5]

VII. ADDITIONAL REQUIREMENTS.

No additional requirements exist except as provided in other sections of this permit including Section B (Title V General Requirements).

*** Permit Shield in Effect. ***

**SECTION E. Source Group Restrictions.**

Group Name: 1C - CLINKER TRANSFER SYSTEM B.H. (NEW)

Group Description: Requirements from Plan Approval #37013C

Sources included in this group:

ID	Name
168	3101 BELT TO CLINKER PILE TRANSFER
198	TRANSFER STATION
199	3101 BELT & 3102 BELT
202	3104 BELT & 3105 BELT
220	3103 BELT & 3104 BELT

I. RESTRICTIONS.**Emission Restriction(s).**

001 [25 Pa. Code §127.12b]

Plan approval terms and conditions.

Particulate emissions from the new baghouses (C198A, C199A, C202A, and C220A) shall not exceed 0.02 grains per dry standard cubic foot (0.02 gr/dscf). [From Plan Approval #37013C, Condition #7]

II. TESTING REQUIREMENTS.

No additional testing requirements exist except as provided in other sections of this permit including Section B (Title V General Requirements).

III. MONITORING REQUIREMENTS.

No additional monitoring requirements exist except as provided in other sections of this permit including Section B (Title V General Requirements).

IV. RECORDKEEPING REQUIREMENTS.

002 [25 Pa. Code §127.12b]

Plan approval terms and conditions.

A log of performed maintenance shall be kept. Records shall be maintained for a minimum of five (5) years and shall be made available to the Department upon request. [From Plan Approval #37013C, Condition #10]

V. REPORTING REQUIREMENTS.

No additional reporting requirements exist except as provided in other sections of this permit including Section B (Title V General Requirements).

VI. WORK PRACTICE REQUIREMENTS.

003 [25 Pa. Code §127.12b]

Plan approval terms and conditions.

(a) Magnehelic gauges, or equivalent, shall be installed on the baghouses in easily accessible locations. The gauges shall be maintained in good working order at all times. [From Plan Approval #37013C, Condition #8]

(b) The facility shall maintain sufficient replacement bags for the baghouses onsite, or shall have immediate access to replacement bags in the event of bag failure. [From Plan Approval #37013C, Condition #9]

(c) The source shall not be operated while the baghouses are not in operation. [From Plan Approval #37013C, Condition #9]

(d) The facility shall conduct a preventative maintenance program for each control device that includes daily, monthly, and yearly inspections of the control device. [From Plan Approval #37013C, Condition #10 and 25 Pa. Code §127.511]

VII. ADDITIONAL REQUIREMENTS.

No additional requirements exist except as provided in other sections of this permit including Section B (Title V General Requirements).



SECTION E. Source Group Restrictions.

*** Permit Shield in Effect. ***

**SECTION E. Source Group Restrictions.**

Group Name: 2 - CEMENT KILNS W/NESHAP REQ.

Group Description:

Sources included in this group:

ID	Name
226	#1 KILN
227	#2 KILN
228	#3 KILN

I. RESTRICTIONS.**Emission Restriction(s).**

001 [25 Pa. Code §123.13]

Processes

No person may permit the emission into the outdoor atmosphere of particulate matter, at any time, either in excess of the rate calculated by the following formula or in such a manner that the concentration of particulate matter in the effluent gas exceeds .02 grains per dry standard cubic foot, whichever is greater:

Formula

$$A = .76E^{(0.42)}$$

where:

A = Allowable emissions in pounds per hour.

E = Emission index = F x W pounds per hour.

F = Process factor in pounds per unit, and

W = Production or charging rate in units per hour.

For portland cement manufacturing (clinker production), the factor F shall be 150(dry solids feed). The units for F and W shall be compatible.

002 [25 Pa. Code §123.21]

General

No person may permit the emission into the outdoor atmosphere of sulfur oxides from a source in a manner that the concentration of the sulfur oxides, expressed as SO₂, in the effluent gas exceeds 500 parts per million, by volume, dry basis.

003 [25 Pa. Code §127.441]

Operating permit terms and conditions.

(a) Implementation of combustion controls, raw feed mix variability control, and operator training in NO_x generation minimization techniques shall be defined as RACT to NO_x emissions from Kilns #1, 2, and 3.

(b) NO_x emissions from Kilns #1, 2, and 3 shall not exceed 6.2 lbs. per ton of clinker produced, per kiln, based on a 30-day rolling average. Compliance with the NO_x emission limit will be determined through the use of a continuous emission monitor (CEM), placed in the common stack. Average readings at or below 6.2 lbs. of NO_x/ton of clinker produced will be considered compliant with the individual kiln limits. [In accordance with 25 Pa. Code §145.143, during the time period from May 1 through September 30 of each year, the allowable NO_x emission rate for the entire period is 3.44 pounds per ton of clinker produced.]

(c) The Department reserves the right to develop more restrictive NO_x emission limits based on CEM data.

[From RACT Operating Permit #OP 37-013, issued February 8, 2000. Authority for this permit condition is also derived from 25 Pa. Code Section 129.91.]

004 [25 Pa. Code §127.441]

Operating permit terms and conditions.

§ 63.1343 What standards apply to my kilns, clinker coolers, raw material dryers, and open clinker piles?

(a) General. The provisions in this section apply to each kiln and any alkali bypass associated with that kiln, clinker cooler,



SECTION E. Source Group Restrictions.

and raw material dryer. All dioxin D/F, HCl, and total hydrocarbon (THC) emission limits are on a dry basis. The D/F, HCl and THC limits for kilns are corrected to 7 percent oxygen except during periods of startup and shutdown. The raw material dryer THC limits are corrected to 19 percent oxygen except during startup and shutdown. During startup and shutdown no oxygen correction is applied. All (THC) emission limits are measured as propane. Standards for mercury, PM, and THC are based on a 30-day rolling average, except for periods of startup and shutdown, where the standard is based on a 7-day rolling average. The 30-day and 7-day periods mean 30 and 7 consecutive operating days, respectively, where an operating day is any daily 24-hour period during which the kiln operates. Data attributed to an operating day includes all valid data obtained during the daily 24-hour period and excludes any measurements made when the kiln was not operating. If using a CEMS to determine compliance with the HCl standard, this standard is based on a 30-day rolling average, except for periods of startup and shutdown, where the standard is based on a 7-day rolling average. You must ensure appropriate corrections for moisture are made when measuring flowrates used to calculate particulate matter (PM) and mercury emissions.

(b)(1) Kilns, clinker coolers, raw material dryers, raw mills, and finish mills. The emission limits for these sources are shown in table 1.

[Table 1 excerpt]

During normal operations the emissions from the kiln shall not exceed:

- a) PM - 0.04 lb/ton of clinker
- b) D/F - 0.2 ng/dscm corrected to 7% oxygen (TEQ)
- c) Mercury - 55 lb/MM Tons clinker
- d) THC - 24 ppmvd corrected to 7% oxygen
- e) HCL - 3 ppmvd corrected to 7 % oxygen

During startup and shutdown mode the emissions from the kiln shall not exceed:

- a) PM - 0.004 gr/dscf
- b) D/F - 0.2 ng/dscm (TEQ)
- c) Mercury - 10 ug/dscm
- d) THC - 24 ppmvd
- e) HCL - 3 ppmvd

[Footnotes to Table 1]

1If the average temperature at the inlet to the first particulate matter control device (fabric filter or electrostatic precipitator) during the D/F performance test is 400 °F or less this limit is changed to 0.4 ng/dscm (TEQ).

2Measured as propane.

3Any source subject to the 24 ppmvd THC limit may elect to meet an alternative limit of 9 ppmvd for total organic HAP. If the source demonstrates compliance with the total organic HAP under the requirements of §63.1349 then the source's THC limit will be adjusted to equal the average THC emissions measured during the organic HAP compliance test.

4If the kiln does not have a HCl CEM, the emissions limit is zero.

(b)(2) When there is an alkali bypass associated with a kiln, the combined PM emissions from the kiln or in-line kiln/raw mill and the alkali bypass stack are subject to the PM emissions limit. Existing kilns that combine the clinker cooler exhaust with the kiln exhaust for energy efficiency purposes and send the combined exhaust to the PM control device as a single stream may meet an alternative PM emissions limit. This limit is calculated using the equation 1 of this section:

$$PM_{alt} = 0.004 \times 1.65 \times (Q_i + Q_c) / 7000$$

Where:

0.004 is the PM exhaust concentration (gr/dscf) equivalent to 0.04 lb per ton clinker where clinker cooler and kiln exhaust gas are not combined.

1.65 is the conversion factor of lb feed per lb clinker

Q_k is the exhaust flow of the kiln (dscf/ton raw feed)



SECTION E. Source Group Restrictions.

Qc is the exhaust flow of the clinker cooler (dscf/ton raw feed).

(c) NA

(d) If clinker material storage and handling activities occur 1,000 feet or less from the facility property-line these activities must be in an enclosed storage area that meets the emissions limits specified in §63.1345.

(e) Emissions limits in effect prior to September 9, 2010. Any source defined as an existing source in §63.1351, and that was subject to a PM, mercury, THC, D/F, or opacity emissions limit prior to September 9, 2010, must continue to meet the limits shown in Table 2 to this section until September 9, 2013.

[Table 2 excerpt]

Emissions from the kiln shall not exceed:

- a) PM - 0.3 lb per ton of feed
- b) opacity - 20 percent
- c) D/F - 0.2 ng/dscm (TEQ) corrected to 7 % oxygen

[Table 2 Footnote]

If the average temperature at the inlet to the first particulate matter control device (fabric filter or electrostatic precipitator) during the D/F performance test is 400 °F or less, this limit is changed to 0.4 ng/dscm (TEQ).

005 [25 Pa. Code §127.441]

[Operating permit terms and conditions.](#)

§ 63.1346 Operating limits for kilns.

(a) The owner or operator of a kiln subject to a D/F emission limitation under §63.1343 must operate the kiln such that the temperature of the gas at the inlet to the kiln particulate matter control device (PMCD) and alkali bypass PMCD, if applicable, does not exceed the applicable temperature limit specified in paragraph (b) of this section. The owner or operator of an in-line kiln/raw mill subject to a D/F emission limitation under §63.1343 must operate the in-line kiln/raw mill, such that:

(1) When the raw mill of the in-line kiln/raw mill is operating, the applicable temperature limit for the main in-line kiln/raw mill exhaust, specified in paragraph (b) of this section and established during the performance test when the raw mill was operating is not exceeded, except during periods of startup/shutdown when the temperature limit may be exceeded by no more than 10 percent.

(2) When the raw mill of the in-line kiln/raw mill is not operating, the applicable temperature limit for the main in-line kiln/raw mill exhaust, specified in paragraph (b) of this section and established during the performance test when the raw mill was not operating, is not exceeded, except during periods of startup/shutdown when the temperature limit may be exceeded by no more than 10 percent.

(3) If the in-line kiln/raw mill is equipped with an alkali bypass, the applicable temperature limit for the alkali bypass specified in paragraph (b) of this section and established during the performance test, with or without the raw mill operating, is not exceeded, except during periods of startup/shutdown when the temperature limit may be exceeded by no more than 10 percent.

(b) The temperature limit for affected sources meeting the limits of paragraph (a) of this section or paragraphs (a)(1) through (a)(3) of this section is determined in accordance with §63.1349(b)(3)(iv).

(c) For an affected source subject to a D/F emission limitation under §63.1343 that employs sorbent injection as an emission control technique you must operate the sorbent injection system in accordance with paragraphs (c)(1) and (c)(2) of this section.

(1) The three-hour rolling average activated sorbent injection rate must be equal to or greater than the sorbent injection rate determined in accordance with §63.1349(b)(3)(vi).

(2) You must either:

(i) Maintain the minimum activated carbon injection carrier gas flow rate, as a three-hour rolling average, based on the

**SECTION E. Source Group Restrictions.**

manufacturer's specifications. These specifications must be documented in the test plan developed in accordance with §63.7(c), or

(ii) Maintain the minimum activated carbon injection carrier gas pressure drop, as a three-hour rolling average, based on the manufacturer's specifications. These specifications must be documented in the test plan developed in accordance with §63.7(c).

(d) Except as provided in paragraph (e) of this section, for an affected source subject to a D/F emission limitation under §63.1343 that employs carbon injection as an emission control technique you must specify and use the brand and type of sorbent used during the performance test until a subsequent performance test is conducted, unless the site-specific performance test plan contains documentation of key parameters that affect adsorption and the owner or operator establishes limits based on those parameters, and the limits on these parameters are maintained.

(e) For an affected source subject to a D/F emission limitation under §63.1343 that employs carbon injection as an emission control technique you may substitute, at any time, a different brand or type of sorbent provided that the replacement has equivalent or improved properties compared to the sorbent specified in the site-specific performance test plan and used in the performance test. The owner or operator must maintain documentation that the substitute sorbent will provide the same or better level of control as the original sorbent.

(f) No kiln may use as a raw material or fuel any fly ash where the mercury content of the fly ash has been increased through the use of activated carbon, or any other sorbent, unless the facility can demonstrate that the use of that fly ash will not result in an increase in mercury emissions over baseline emissions (i.e., emissions not using the fly ash). The facility has the burden of proving there has been no emissions increase over baseline. Once the kiln must comply with a mercury limit specified in §63.1343, this paragraph no longer applies.

[75 FR 55054, Sept. 9, 2010]

006 [25 Pa. Code §127.441]

[Operating permit terms and conditions.](#)

§ 63.1348 Compliance requirements.

The permittee shall comply with the applicable performance testing requirements of 40 CFR 63.1348 [See Section C, Additional Requirements], as identified below:

(a) Applicable

(1) Applicable

(2) Not Applicable

(3) - (6) Applicable

(b) Applicable

(1) - (2) Applicable

(3) Not Applicable

(4) - (8) Applicable

(c) - (d) Applicable

[Fuel Restriction\(s\).](#)

007 [25 Pa. Code §127.441]

[Operating permit terms and conditions.](#)

a. The facility is authorized to use non-hazardous engineered fuels (manufactured by Vexor) as a fuel for Sources 226, 227, and 228. All engineered fuel is to be certified as non-hazardous material prior to use in the kilns and shall meet the characteristics approved in the Request for Determination of March 5, 2007.

**SECTION E. Source Group Restrictions.**

b. The use of engineered fuel as a fuel for these sources shall be limited to 3.6 tons per hour per kiln based on a daily average (24 hours).

Throughput Restriction(s).

008 [25 Pa. Code §127.12b]

Plan approval terms and conditions.

The heat input to each kiln, from all sources of fuel, shall not exceed 195 MMBTU/hr., based on a 30-day rolling average.

[From Plan Approval No. 37-013F, Condition No. 005]

009 [25 Pa. Code §127.441]

Operating permit terms and conditions.

(a) This facility is authorized to use spent activated carbon as a fuel for Sources 226, 227, and 228. All spent activated carbon used as a fuel for these sources is required to be analyzed for hazardous material content prior to use. Any spent activated carbon containing materials that may be defined as hazardous waste is not approved for use in the cement kilns.

(b) The use of spent activated carbon as a fuel for these sources is limited to 6 tons per hour, combined for Sources 226, 227, and 228.

010 [25 Pa. Code §127.441]

Operating permit terms and conditions.

a) Any Class A dried sewage sludge that contains hazardous materials is not approved for use in the cement kilns listed above. 'Hazardous Waste' is defined in the Work Practice Requirements of this section.

b) The combustion of Class A dried sewage sludge as fuel for the this cement kiln is limited to 1.5 tons/hour based on a daily average (24 hours).

II. TESTING REQUIREMENTS.

011 [25 Pa. Code §127.441]

Operating permit terms and conditions.

All Class A dried sewage sludge used as a fuel for the kilns listed above is required to be analysed for hazardous material content prior to use.

012 [25 Pa. Code §127.441]

Operating permit terms and conditions.

a. All engineered fuel used as a fuel for the cement kilns (Sources 226, 227, and 228) shall be certified as non-hazardous prior to use.

b. Samples of each shipment of non-hazardous engineered fuels shall be analyzed for the following criteria prior to receipt by the facility.

- i. Arsenic
- ii. Barium
- iii. Beryllium
- iv. Cadmium
- v. Chromium
- vi. Copper
- vii. Lead
- viii. Mercury
- ix. Nickel
- x. Reactive Cyanide
- xi. Reactive Sulfide
- xii. Selenium
- xiii. Silver
- xiv. BTU content
- xv. pH

**SECTION E. Source Group Restrictions.**

- xvi. Sulfur, Total
- xvii. Total halogens

c. The fuel analysis shall be conducted on site by the permittee or shall be conducted by the supplier (Vexor). The records of the analysis shall be kept at the facility by the permittee.

013 [40 CFR Part 63 NESHAPS for Source Categories §40 CFR 63.1349]

Subpart LLL -- National Emission Standards for Hazardous Air Pollutants From the Portland Cement Manufacturing Industry

Performance testing requirements.

The permittee shall comply with the applicable performance testing requirements of 40 CFR 63.1349 [See Section C, Additional Requirements], as identified below:

- (a) Applicable.
- (b) Applicable.
 - (1) Applicable.
 - (2) Not Applicable.
 - (3) - (6) Applicable.
- (c) Applicable.
- (d) Applicable.
- (e) Applicable.

III. MONITORING REQUIREMENTS.

014 [25 Pa. Code §127.12b]

Plan approval terms and conditions.

(a) The permittee shall operate and maintain the Continuous Opacity Monitor in accordance with 25 Pa. Code Chapter 139 and the Department's latest Continuous Source Monitoring Manual. The Continuous Opacity Monitor shall be designed to determine compliance with the opacity NESHAP opacity requirement of 20% over any 6-minute period.

(b) The Continuous Opacity Monitor shall also be operated and maintained in accordance with the quality assurance, record keeping, and reporting requirements of 25 Pa. Code Chapter 139 and the Department's latest Continuous Source Monitoring Manual.

015 [25 Pa. Code §127.12b]

Plan approval terms and conditions.

Compliance with the heat input restriction shall be based on continuous monitoring of kiln fuel usage and periodic measuring of fuel heat content on a weekly basis.

[From Plan Approval 37-013F, Condition #010]

016 [25 Pa. Code §127.441]

Operating permit terms and conditions.

A NOx continuous emission monitor (CEM) shall be installed to monitor NOx emissions in the combined effluent stack of the kilns. The CEM shall be installed in accordance with 25 Pa. Code Chapter 139, and the latest version of the "Continuous Source Monitoring Manual", published by the Department. Department approval of Phase I of the NOx CEM requirement, as defined in the source monitoring manual, shall be implemented within six (6) months of the issue date of the revised RACT operating permit [February 8, 2000]. Phase II shall be completed within 180 days of Phase I approval. Phase III shall be submitted to the Department within 60 days of completion of Phase II.

[From RACT Operating Permit #OP 37-013, issued February 8, 2000. Authority for this permit condition is also derived from 25 Pa. Code Section 129.91.]



SECTION E. Source Group Restrictions.

017 [25 Pa. Code §127.441]

Operating permit terms and conditions.

The permittee shall monitor the amount of spent activated carbon used as a fuel in the each kiln.

018 [25 Pa. Code §127.441]

Operating permit terms and conditions.

a. The permittee shall monitor the amount of non-hazardous engineered fuels burned in each kiln as fuel on an hourly basis (tons per hour).

019 [25 Pa. Code §127.511]

Monitoring and related recordkeeping and reporting requirements.

(a) The permittee shall install, certify, maintain and operate a continuous emission monitor to measure the sulfur oxide emissions from this source. The monitor shall report sulfur oxide emissions, expressed as SO₂, in ppm, based on a 3-hour average, rolling by 1-hour periods.

(b) This continuous emission monitor shall be installed, approved by the Department, maintained, and operated in accordance with the Submittal and Approval, Recordkeeping and Reporting, and the Quality Assurance requirements of the Department's Continuous Source Monitoring Manual and with 25 Pa. Code Chapter 139.

(c) The data availability standard for each monitor shall be 90 percent of the 3-hour averages per month or 95% of the hours per calendar quarter.

(d) The permittee shall maintain a record of all maintenance operations and periodic calibrations conducted on the continuous emission monitor.

020 [40 CFR Part 63 NESHAPS for Source Categories §40 CFR 63.1350]

Subpart LLL -- National Emission Standards for Hazardous Air Pollutants From the Portland Cement Manufacturing Industry

Monitoring requirements.

The permittee shall comply with the applicable monitoring requirements of 40 CFR 63.1350 [See Section C, Additional Requirements], as identified below:

(a) Applicable.

(b) Applicable.

(c) [Reserved]

(d) Applicable.

(e) [Reserved]

(f) Not Applicable

(g) - (p) Applicable

021 [40 CFR Part 63 NESHAPS for Source Categories §40 CFR 63.1357]

Subpart LLL -- National Emission Standards for Hazardous Air Pollutants From the Portland Cement Manufacturing Industry

Temporary, conditioned exemption from particulate matter and opacity standards.

(a) Subject to the limitations of Paragraphs (b) through (f) of this section, an owner or operator conducting PM CEMS correlation tests (that is, correlation with manual stack methods) is exempt from:

(1) Any particulate matter and opacity standards of [40 CFR] Part 60 or Part 63 that are applicable to cement kilns and in-line kiln/raw mills.

(2) Any permit or other emissions or operating parameter or other limitation on workplace practices that are applicable to cement kilns and in-line kiln raw mills to ensure compliance with any particulate matter and opacity standards of this part or Part 60.

**SECTION E. Source Group Restrictions.**

(b) The owner or operator must develop a PM CEMS correlation test plan. The plan must be submitted to the Administrator for approval at least 90 days before the correlation test is scheduled to be conducted. The plan must include:

- (1) The number of test conditions and the number of runs for each test condition;
- (2) The target particulate matter emission level for each test condition;
- (3) How the operation of the affected source will be modified to attain the desired particulate matter emission rate; and
- (4) The anticipated normal particulate matter emission level.

(c) The Administrator will review and approve or disapprove the correlation test plan in accordance with Section 63.7(c)(3)(i) and (iii). If the Administrator fails to approve or disapprove the correlation test plan within the time period specified in Section 63.7(c)(3)(iii), the plan shall be considered approved, unless the Administrator has requested additional information.

(d) The stack sampling team must be on-site and prepared to perform correlation testing no later than 24 hours after operations are modified to attain the desired particulate matter emissions concentrations, unless the correlation test plan documents that a longer period is appropriate.

(e) The particulate matter and opacity standards and associated operating limits and conditions will not be waived for more than 96 hours, in the aggregate, for a correlation test, including all runs and conditions.

(f) The owner or operator must return the affected source to operating conditions indicative of compliance with the applicable particulate matter and opacity standards as soon as possible after correlation testing is completed.

IV. RECORDKEEPING REQUIREMENTS.

022 [25 Pa. Code §127.12b]

Plan approval terms and conditions.

Records shall be maintained of total fuel usage and fuel heat content. The records shall be maintained in a manner that demonstrates monthly fuel usage and the average heat content of fuels used during any 30-day rolling average. Records shall be maintained onsite for a minimum of five years and shall be made available to the Department upon request.

[From Plan Approval 37-013F, Condition #012]

023 [25 Pa. Code §127.441]

Operating permit terms and conditions.

Records of clinker production, sufficient to define compliance with the NOx emission limit defined in this permit shall be maintained in accordance with 25 Pa. Code Section 129.95. Records shall be maintained onsite for a minimum of 5 years, and shall be made available to the Department upon request.

024 [25 Pa. Code §127.441]

Operating permit terms and conditions.

(a) The permittee shall maintain records of the hazardous material content of each shipment of spent activated carbon accepted by the permittee for use in the kilns.

(b) The permittee shall record the amount of spent activated carbon used in each kiln each hour that spent activated carbon is being used.

025 [25 Pa. Code §127.441]

Operating permit terms and conditions.

a) The facility shall maintain records of the hazardous material content of all Class A dried sewage sludge accepted for use as a fuel in the kilns.

b) If there are no changes in the Class A dried sewage sludge supplier and no Hazardous Pollutants defined as Hazardous Waste are discovered during a six-month period, a monthly certification stating that the material does not contain hazardous waste and an analysis of hazardous waste content provided by the supplier or CEMEX will demonstrate compliance with the recordkeeping requirement of a) above. The monthly analysis and certification will be maintained on-site and made available to the Department upon request.

c) All records shall be kept for a period of five years.

**SECTION E. Source Group Restrictions.**

026 [25 Pa. Code §127.441]

Operating permit terms and conditions.

The facility shall keep an on-site facility log for the amount of Class A dried sewage sludge fuel used in each kiln on a daily basis

027 [25 Pa. Code §127.441]

Operating permit terms and conditions.

a. The permittee shall maintain records of the amount of non-hazardous engineered fuels used in each kiln.

b. The permittee shall keep records of the fuel sampling analysis for each shipment of non-hazardous engineered fuel.

028 [25 Pa. Code §127.511]

Monitoring and related recordkeeping and reporting requirements.

The permittee shall maintain a log of all inspections of the control device associated with each source. These logs shall, at a minimum, contain the dates for the inspections, any problems or defects observed during the inspection, the actions taken to correct the problem or defect, any routine maintenance performed, and the readings of the operating parameters required to be monitored.

029 [25 Pa. Code §129.95]

Recordkeeping

(a) The owner and operator of a major NO_x emitting facility or a major VOCs emitting facility shall keep records to demonstrate compliance with 129.91 -- 129.94.

(b) The records shall provide sufficient data and calculations to clearly demonstrate that the requirements of 129.91 -- 129.94 are met.

(c) Data or information required to determine compliance shall be recorded and maintained in a time frame consistent with the averaging period of the requirement.

(d) The records shall be retained for at least 2 years and shall be made available to the Department on request.

(e) An owner or operator claiming that a facility is exempt from the RACT requirements of 129.91 -- 129.94, based on the facility's potential to emit, shall maintain records that clearly demonstrate to the Department that the facility or source is not subject to 129.91 -- 129.94.

030 [40 CFR Part 63 NESHAPS for Source Categories §40 CFR 63.1355]

Subpart LLL -- National Emission Standards for Hazardous Air Pollutants From the Portland Cement Manufacturing Industry**Recordkeeping requirements.**

The permittee shall comply with the applicable recordkeeping requirements of 40 CFR 63.1355 [See Section C, Additional Requirements], as identified below:

(a) - (g) Applicable.

V. REPORTING REQUIREMENTS.

031 [40 CFR Part 63 NESHAPS for Source Categories §40 CFR 63.1353]

Subpart LLL -- National Emission Standards for Hazardous Air Pollutants From the Portland Cement Manufacturing Industry**Notification requirements.**

The permittee shall comply with the applicable Notification requirements of 40 CFR 63.1353 [See Section C, Additional Requirements], as identified below:

(a) Applicable.

(b) Applicable.

032 [40 CFR Part 63 NESHAPS for Source Categories §40 CFR 63.1354]

Subpart LLL -- National Emission Standards for Hazardous Air Pollutants From the Portland Cement Manufacturing Industry

**SECTION E. Source Group Restrictions.****Reporting requirements.**

The permittee shall comply with the applicable Reporting requirements of 40 CFR 63.1354 [See Section C, Additional Requirements], as identified below:

- (a) Applicable.
- (b) Applicable.
- (c) Applicable.

VI. WORK PRACTICE REQUIREMENTS.

033 [25 Pa. Code §127.441]

Operating permit terms and conditions.

a) Any Class A dried sewage sludge containing TCLP metals or TCLP Organic Chemicals at or above the action concentration for the constituent found at 40 CFR 261.24 is a Hazardous Waste and is not approved for use as a fuel.

b) The facility is authorized to use Class A dried sewer sludge as a fuel for the cement kiln listed in this section. Prior to combusting the Class A dried sewage sludge, on a permanent basis, the permittee must obtain prior approval for the Department's Waste Management Program.

034 [25 Pa. Code §127.511]

Monitoring and related recordkeeping and reporting requirements.

(a) The permittee shall conduct a weekly external preventative maintenance inspection of the control device.

(b) The permittee shall monitor and record the following operational parameter of each field in the electrostatic precipitator on a weekly basis:

1. Primary Voltage
2. Primary Current
3. Secondary Voltage
4. Secondary Current
5. Spark Rate

(c) The permittee shall operate the control device at all times that the source is in operation.

(d) The permittee shall maintain and operate the source and control device in accordance with good air pollution control practices.

VII. ADDITIONAL REQUIREMENTS.

035 [25 Pa. Code §145.143.]

Standard requirements.

(a) By October 31, 2005, and each year thereafter, the owner or operator of a Portland cement kiln shall calculate the difference between the actual emissions from the unit during the period from May 1 through September 30 and the allowable emissions for that period.

(b) The owner or operator of a Portland cement kiln may not operate a Portland cement kiln in a manner that results in NOx emissions in excess of its allowable emissions, except as otherwise specified in this section.

(1) Beginning May 1 through September 30, 2005, and each year thereafter, the owner or operator shall determine allowable emissions by multiplying the tons of clinker produced by the Portland cement kiln for the period by 6 pounds per ton of clinker produced.

(2) Beginning May 1 through September 30, 2011, and each year thereafter, the owner or operator of a Portland cement kiln shall determine allowable emissions of NOx by multiplying the tons of clinker produced by the Portland cement kiln for the period by 3.44 pounds of NOx per ton of clinker produced for long dry process cement kilns.

(c) The owner or operator of a Portland cement kiln subject to subsection (b)(1) shall install and operate a CEMS, and shall report CEMS emissions data, in accordance with the CEMS requirements of either Chapter 139 or 145 (relating to sampling

**SECTION E. Source Group Restrictions.**

and testing; and interstate pollution transport reduction) and calculate actual emissions using the CEMS data reported to the Department. Any data invalidated under Chapter 139 shall be substituted with data calculated using the potential emission rate for the unit or, if approved by the Department in writing, an alternative amount of emissions that is more representative of actual emissions that occurred during the period of invalid data.

(d) The owner or operator of a Portland cement kiln subject to this section shall surrender to the Department one CAIR NOx allowance and one CAIR NOx Ozone Season allowance, as defined in 40 CFR 96.102 and 96.302 (relating to definitions), for each ton of NOx by which the combined actual emissions exceed the allowable emissions of the Portland cement kilns subject to this section at a facility from May 1 through September 30. The surrendered allowances shall be of current year vintage. For the purposes of determining the amount of allowances to surrender, any remaining fraction of a ton equal to or greater than 0.50 ton is deemed to equal 1 ton and any fraction of a ton less than 0.50 ton is deemed to equal zero tons.

(e) If the combined allowable emissions from Portland cement kilns at a facility from May 1 through September 30 exceed the combined actual emissions from Portland cement kilns subject to this section at the facility during the same period, the owner or operator may deduct the difference or any portion of the difference from the amount of actual emissions from Portland cement kilns at the owner or operator's other facilities located in this Commonwealth for that period.

(f) By November 1, 2005, and each year thereafter, an owner or operator subject to this subchapter shall surrender the required NOx allowances to the Department's designated NOx allowance tracking system account, as defined in § 121.1 (relating to definitions), and shall provide in writing to the Department, the following:

- (1) The serial number of each NOx allowance surrendered.
- (2) The calculations used to determine the quantity of NOx allowances required to be surrendered.

(g) If an owner or operator fails to comply with subsection (f), the owner or operator shall by December 31 surrender three NOx allowances of the current or later year vintage for each NOx allowance that was required to be surrendered by November 1.

(h) The surrender of NOx allowances under subsection (g) does not affect the liability of the owner or operator of the Portland cement kiln for any fine, penalty or assessment, or an obligation to comply with any other remedy for the same violation, under the CAA or the act.

(1) For purposes of determining the number of days of violation, if a facility has excess emissions for the period May 1 through September 30, each day in that period (153 days) constitutes a day in violation unless the owner or operator of the Portland cement kiln demonstrates that a lesser number of days should be considered.

- (2) Each ton of excess emissions is a separate violation.

036 [25 Pa. Code §145.144.]

Compliance determination.

(a) By April 15, 2011, the owner or operator of a Portland cement kiln subject to § 145.143(b)(2) (relating to standard requirements) shall:

- (1) Install, operate and maintain CEMS for NOx emissions.
- (2) Report CEMS emissions data, in accordance with the CEMS requirements of Chapter 139, Subchapter C (relating to requirements for source monitoring for stationary sources), to the Department.
- (3) Calculate actual emissions using the CEMS data reported to the Department.

(b) If approved by the Department in writing, data invalidated under Chapter 139, Subchapter C, shall be substituted with one of the following:

- (1) The highest valid 1-hour emission value that occurred under similar source operating conditions during the reporting quarter for an invalid data period during that quarter.
- (2) If no valid data were collected during the reporting quarter, one of the following shall be reported to the Department:

**SECTION E. Source Group Restrictions.**

- (i) The highest valid 1-hour emission value that occurred under similar source operating conditions during the most recent quarter for which valid data were collected.
- (ii) The highest valid 1-hour emission value that occurred under similar source operating conditions during an alternative reporting period.
- (3) An alternative method of data substitution.
- (c) The owner or operator of a Portland cement kiln subject to this section shall submit to the Department quarterly reports of CEMS monitoring data in pounds of NOx emitted per hour, in a format approved by the Department, which is in compliance with Chapter 139, Subchapter C.
- (d) The CEMS for NOx installed under the requirements of this section must meet the minimum data availability requirements in Chapter 139, Subchapter C.

037 [25 Pa. Code §145.145.]

Compliance demonstration and reporting requirements.

- (a) By October 31, 2011, and each year thereafter, the owner or operator of a Portland cement kiln subject to § 145.143(b)(2) (relating to standard requirements) shall submit a written report to the Department, in a format approved by the Department, which includes the following:
 - (1) The difference between the actual NOx emissions from the kiln during the interval from May 1 through September 30 and the allowable emissions for that period.
 - (2) The calculations used to determine the difference in emissions, including the CEMS data and clinker production data used to show compliance with the allowable emission limits in § 145.143(b)(2). The clinker production data must consist of the quantity of clinker, in tons, produced per day for each kiln.
- (b) The owner or operator of a Portland cement kiln shall demonstrate compliance with the standard requirements in § 145.143(b)(2) on one of the following:
 - (1) A kiln-by-kiln basis.
 - (2) A facility-wide basis.
 - (3) A system-wide basis.

*** Permit Shield in Effect. ***

**SECTION E. Source Group Restrictions.**

Group Name: 3 - CLINKER COOLERS W/ NESHAP REQ.

Group Description:

Sources included in this group:

ID	Name
223	#1 CLINKER COOLER
224	#2 CLINKER COOLER
225	#3 CLINKER COOLER

I. RESTRICTIONS.**Emission Restriction(s).**

001 [25 Pa. Code §123.13]

Processes

No person may permit the emission into the outdoor atmosphere of particulate matter in excess of the rate calculated by the following formula or in such a manner that the concentration of particulate matter in the effluent gas exceeds .02 grains per dry standard cubic foot, whichever is greater:

Formula

$$A = .76E^{(0.42)}$$

where:

A = Allowable emissions in pounds per hour.

E = Emission index = F x W pounds per hour.

F = Process factor in pounds per unit, and

W = Production or charging rate in units per hour.

For portland cement manufacturing (clinker cooling), the factor F shall be 50 (product). The units for F and W shall be compatible.

002 [25 Pa. Code §127.441]

Operating permit terms and conditions.

§ 63.1343 What standards apply to my kilns, clinker coolers, raw material dryers, and open clinker piles?

(a) General. The provisions in this section apply to each kiln and any alkali bypass associated with that kiln, clinker cooler, and raw material dryer. All dioxin D/F, HCl, and total hydrocarbon (THC) emission limits are on a dry basis. The D/F, HCl and THC limits for kilns are corrected to 7 percent oxygen except during periods of startup and shutdown. The raw material dryer THC limits are corrected to 19 percent oxygen except during startup and shutdown. During startup and shutdown no oxygen correction is applied. All (THC) emission limits are measured as propane. Standards for mercury, PM, and THC are based on a 30-day rolling average, except for periods of startup and shutdown, where the standard is based on a 7-day rolling average. The 30-day and 7-day periods mean 30 and 7 consecutive operating days, respectively, where an operating day is any daily 24-hour period during which the kiln operates. Data attributed to an operating day includes all valid data obtained during the daily 24-hour period and excludes any measurements made when the kiln was not operating. If using a CEMS to determine compliance with the HCl standard, this standard is based on a 30-day rolling average, except for periods of startup and shutdown, where the standard is based on a 7-day rolling average. You must ensure appropriate corrections for moisture are made when measuring flowrates used to calculate particulate matter (PM) and mercury emissions.

(b)(1) Kilns, clinker coolers, raw material dryers, raw mills, and finish mills. The emission limits for these sources are shown in table 1.

[Table 1 excerpt]

During normal operations the emissions from the clinker cooler shall not exceed:

a) PM - 0.04 lb/ton of clinker

During startup or shutdown mode the emissions from the kiln shall not exceed:

a) PM - 0.004 gr/dscf

(b)(2) When there is an alkali bypass associated with a kiln, the combined PM emissions from the kiln or in-line kiln/raw mill



SECTION E. Source Group Restrictions.

and the alkali bypass stack are subject to the PM emissions limit. Existing kilns that combine the clinker cooler exhaust with the kiln exhaust for energy efficiency purposes and send the combined exhaust to the PM control device as a single stream may meet an alternative PM emissions limit. This limit is calculated using the equation 1 of this section:

$$PM_{alt} = 0.004 \times 1.65 \times (Q_i + Q_c) / 7000$$

Where:

0.004 is the PM exhaust concentration (gr/dscf) equivalent to 0.04 lb per ton clinker where clinker cooler and kiln exhaust gas are not combined.

1.65 is the conversion factor of lb feed per lb clinker

Q_k is the exhaust flow of the kiln (dscf/ton raw feed)

Q_c is the exhaust flow of the clinker cooler (dscf/ton raw feed).

(c) NA

(d) If clinker material storage and handling activities occur 1,000 feet or less from the facility property-line these activities must be in an enclosed storage area that meets the emissions limits specified in §63.1345.

(e) Emissions limits in effect prior to September 9, 2010. Any source defined as an existing source in §63.1351, and that was subject to a PM, mercury, THC, D/F, or opacity emissions limit prior to September 9, 2010, must continue to meet the limits shown in Table 2 to this section until September 9, 2013.

[Table 2 excerpt]

Emissions from the kiln shall not exceed:

- a) PM - 0.1 lb per ton of feed
- b) opacity - 10 percent

003 [25 Pa. Code §127.441]

[Operating permit terms and conditions.](#)

§ 63.1348 Compliance requirements.

The permittee shall comply with the applicable performance testing requirements of 40 CFR 63.1348 [See Section C, Additional Requirements], as identified below:

(a) Applicable

(1) Applicable

(2) - (6) Not Applicable

(b) Applicable

(1) - (2) Applicable

(3) - (8) Not Applicable

(c) Applicable

(d) Applicable

**SECTION E. Source Group Restrictions.****II. TESTING REQUIREMENTS.**

- # 004 [40 CFR Part 63 NESHAPS for Source Categories §40 CFR 63.1349]
 Subpart LLL -- National Emission Standards for Hazardous Air Pollutants From the Portland Cement Manufacturing Industry
 Performance testing requirements.
 The permittee shall comply with the applicable performance testing requirements of 40 CFR 63.1349 [See Section C, Additional Requirements], as identified below:
- (a) Applicable.
 - (b) Applicable.
 - (1) Applicable.
 - (2) - (6) Not Applicable.
 - (c) Not Applicable.
 - (d) Applicable.
 - (e) Applicable.

III. MONITORING REQUIREMENTS.

- # 005 [40 CFR Part 63 NESHAPS for Source Categories §40 CFR 63.1350]
 Subpart LLL -- National Emission Standards for Hazardous Air Pollutants From the Portland Cement Manufacturing Industry
 Monitoring requirements.
 The permittee shall comply with the applicable Monitoring requirements of 40 CFR 63.1350 [See Section C, Additional Requirements], as identified below:
- (a) Applicable.
 - (b) Applicable.
 - (c) Reserved
 - (d) Applicable.
 - (e) Reserved
 - (f) - (m) Not Applicable.
 - (n) Applicable
 - (o) Not Applicable
 - (p) Applicable

IV. RECORDKEEPING REQUIREMENTS.

- # 006 [25 Pa. Code §127.511]
 Monitoring and related recordkeeping and reporting requirements.
 The permittee shall maintain a log of all inspections of the control device associated with each source. The log shall, at a minimum, contain the dates of the inspections, any problems or defects observed during the inspection, the actions taken to correct the problem or defect, any routing maintenance performed, and the pressure drop across the control device.
- # 007 [40 CFR Part 63 NESHAPS for Source Categories §40 CFR 63.1355]
 Subpart LLL -- National Emission Standards for Hazardous Air Pollutants From the Portland Cement Manufacturing Industry
 Recordkeeping requirements.

**SECTION E. Source Group Restrictions.**

The permittee shall comply with the applicable Recordkeeping requirements of 40 CFR 63.1355 [See Section C, Additional Requirements], as identified below:

- (a) - (c) Applicable.
- (d) Not Applicable.
- (e) - (g) Applicable.

V. REPORTING REQUIREMENTS.

008 [40 CFR Part 63 NESHAPS for Source Categories §40 CFR 63.1353]

Subpart LLL -- National Emission Standards for Hazardous Air Pollutants From the Portland Cement Manufacturing Industry

Notification requirements.

The permittee shall comply with the applicable Notification requirements of 40 CFR 63.1353 [See Section C, Additional Requirements], as identified below:

- (a) Applicable.
- (b) Applicable.

009 [40 CFR Part 63 NESHAPS for Source Categories §40 CFR 63.1354]

Subpart LLL -- National Emission Standards for Hazardous Air Pollutants From the Portland Cement Manufacturing Industry

Reporting requirements.

The permittee shall comply with the applicable Reporting requirements of 40 CFR 63.1354 [See Section C, Additional Requirements], as identified below:

- (a) - (c) Applicable.

VI. WORK PRACTICE REQUIREMENTS.

010 [25 Pa. Code §127.511]

Monitoring and related recordkeeping and reporting requirements.

- (a) The permittee shall perform a weekly external preventative maintenance inspection of the control device.
- (b) The permittee shall maintain a manometer or similar device to measure the pressure drop across the control device.
- (c) The permittee shall operate the control device at all times that this source is in operation.
- (d) The permittee shall maintain and operate this source and control device in accordance with the manufacturer's specifications.

VII. ADDITIONAL REQUIREMENTS.

No additional requirements exist except as provided in other sections of this permit including Section B (Title V General Requirements).

*** Permit Shield in Effect. ***

**SECTION E. Source Group Restrictions.**

Group Name: 4 - RAW AND FINISH MILL NESHAP REQ.

Group Description:

Sources included in this group:

ID	Name
195	#1 RAW MILL & SEPARATOR
196	#2 RAW MILL & SEPARATOR
197	#3 RAW MILL & SEPARATOR
222	#2 FINISH MILL SEPARATOR
234	#1 FINISH MILL & SEPARATOR
235	#2 FINISH MILL

I. RESTRICTIONS.**Emission Restriction(s).**

001 [25 Pa. Code §127.441]

Operating permit terms and conditions.

§ 63.1343 What standards apply to my kilns, clinker coolers, raw material dryers, and open clinker piles?

(a) General. The provisions in this section apply to each kiln and any alkali bypass associated with that kiln, clinker cooler, and raw material dryer. All dioxin D/F, HCl, and total hydrocarbon (THC) emission limits are on a dry basis. The D/F, HCl and THC limits for kilns are corrected to 7 percent oxygen except during periods of startup and shutdown. The raw material dryer THC limits are corrected to 19 percent oxygen except during startup and shutdown. During startup and shutdown no oxygen correction is applied. All (THC) emission limits are measured as propane. Standards for mercury, PM, and THC are based on a 30-day rolling average, except for periods of startup and shutdown, where the standard is based on a 7-day rolling average. The 30-day and 7-day periods mean 30 and 7 consecutive operating days, respectively, where an operating day is any daily 24-hour period during which the kiln operates. Data attributed to an operating day includes all valid data obtained during the daily 24-hour period and excludes any measurements made when the kiln was not operating. If using a CEMS to determine compliance with the HCl standard, this standard is based on a 30-day rolling average, except for periods of startup and shutdown, where the standard is based on a 7-day rolling average. You must ensure appropriate corrections for moisture are made when measuring flowrates used to calculate particulate matter (PM) and mercury emissions.

(b)(1) Kilns, clinker coolers, raw material dryers, raw mills, and finish mills. The emission limits for these sources are shown in table 1.

[Table 1 excerpt]

During normal operations the emissions from the raw material dryer shall not exceed:

- a) THC- 24 ppmvd corrected to 19% oxygen
- b) opacity - 10 percent

During startup or shutdown mode the emissions from the raw material dryer shall not exceed:

- a) THC- 24 ppmvd
- b) opacity - 10 percent

During all operating modes (normal, startup, or shutdown), the emissions from the raw or finish mill shall not exceed:

- a) opacity - 10 percent

[Footnotes to Table 1]

THC measured as propane.

Any source subject to the 24 ppmvd THC limit may elect to meet an alternative limit of 9 ppmvd for total organic HAP. If the source demonstrates compliance with the total organic HAP under the requirements of Section 63.1349 then the sources's THC limit will be adjusted to equal the average THC emissions measured during the organic HAP compliance test.

(b)(2) Not Applicable

(c) Not Applicable

(d) If clinker material storage and handling activities occur 1,000 feet or less from the facility property-line these activities

**SECTION E. Source Group Restrictions.**

must be in an enclosed storage area that meets the emissions limits specified in §63.1345.

(e) Emissions limits in effect prior to September 9, 2010. Any source defined as an existing source in §63.1351, and that was subject to a PM, mercury, THC, D/F, or opacity emissions limit prior to September 9, 2010, must continue to meet the limits shown in Table 2 to this section until September 9, 2013.

[Table 2 excerpt]

Emissions from the kiln shall not exceed:

a) opacity - 10 percent

002 [25 Pa. Code §127.441]

[Operating permit terms and conditions.](#)

§ 63.1348 Compliance requirements.

The permittee shall comply with the applicable performance testing requirements of 40 CFR 63.1348 [See Section C, Additional Requirements], as identified below:

(a) Applicable

(1) Not Applicable

(2) Applicable

(3) - (6) Not Applicable

(b) Applicable

(1) Applicable

(2) Not Applicable

(3) Applicable

(4) - (8) Not Applicable

(c) Applicable

(d) Applicable

II. TESTING REQUIREMENTS.

003 [40 CFR Part 63 NESHAPS for Source Categories §40 CFR 63.1349]

[Subpart LLL -- National Emission Standards for Hazardous Air Pollutants From the Portland Cement Manufacturing Industry](#)

[Performance testing requirements.](#)

The permittee shall comply with the applicable performance testing requirements of 40 CFR 63.1349 [See Section C, Additional Requirements], as identified below:

(a) Applicable.

(b) Applicable.

(1) Not Applicable.

(2) Applicable.

(3) Not Applicable.



SECTION E. Source Group Restrictions.

(4) Applicable.

(5-6) Not Applicable

(c) Applicable.

(d) Applicable.

(e) Applicable.

III. MONITORING REQUIREMENTS.

004 [40 CFR Part 63 NESHAPS for Source Categories §40 CFR 63.1350]

Subpart LLL -- National Emission Standards for Hazardous Air Pollutants From the Portland Cement Manufacturing Industry

Monitoring requirements.

The permittee shall comply with the applicable Monitoring requirements of 40 CFR 63.1350 [See Section C, Additional Requirements], as identified below:

(a) Applicable.

(b) Not Applicable.

(c) Reserved.

(d) Not Applicable.

(e) Reserved.

(f) Applicable.

(g) Not Applicable.

(h) Not Applicable.

(i) Applicable.

(j) Applicable.

(k) - (o) Not Applicable.

(p) Applicable

IV. RECORDKEEPING REQUIREMENTS.

005 [40 CFR Part 63 NESHAPS for Source Categories §40 CFR 63.1354]

Subpart LLL -- National Emission Standards for Hazardous Air Pollutants From the Portland Cement Manufacturing Industry

Reporting requirements.

The permittee shall comply with the applicable Reporting requirements of 40 CFR 63.1354 [See Section C, Additional Requirements], as identified below:

(a) Applicable.

(b) Applicable.

(c) Applicable.

006 [40 CFR Part 63 NESHAPS for Source Categories §40 CFR 63.1355]

Subpart LLL -- National Emission Standards for Hazardous Air Pollutants From the Portland Cement Manufacturing Industry

**SECTION E. Source Group Restrictions.****Recordkeeping requirements.**

The permittee shall comply with the applicable Recordkeeping requirements of 40 CFR 63.1355 [See Section C, Additional Requirements], as identified below:

(a) - (c) Applicable.

(d) - (e) Not Applicable.

(f) - (g) Applicable.

V. REPORTING REQUIREMENTS.

007 [40 CFR Part 63 NESHAPS for Source Categories §40 CFR 63.1353]

Subpart LLL -- National Emission Standards for Hazardous Air Pollutants From the Portland Cement Manufacturing Industry

Notification requirements.

The permittee shall comply with the applicable Notification requirements of 40 CFR 63.1353 [See Section C, Additional Requirements], as identified below:

(a) Applicable.

(b) Applicable.

VI. WORK PRACTICE REQUIREMENTS.

No additional work practice requirements exist except as provided in other sections of this permit including Section B (Title V General Requirements).

VII. ADDITIONAL REQUIREMENTS.

No additional requirements exist except as provided in other sections of this permit including Section B (Title V General Requirements).

*** Permit Shield in Effect. ***

**SECTION E. Source Group Restrictions.**

Group Name: 5 - OTHER NESHAP AFFECTED SOURCES

Group Description:

Sources included in this group:

ID	Name
103	#4 BELT TO TURN HEAD TRANSFER
111	#3 BELT TO TURN HEAD TRANSFER
112	#7 BELT TO #4 SILO TRANSFER
113	GYP SUM BELT TO #15 SILO TRANSFER
114	DIVERTER BOX TO #8 BELT TRANSFER
115	TURN HEAD TO #5 SILO TRANSFER
116	DIVERTER BOX TO LIMESTONE BELT TRANSFER
117	LIMESTONE BELT TO DIVERTER BOX TRANSFER
118	DIVERTER BOX TO LIMESTONE BELT TRANSFER
119	LIMESTONE BELT TO #1 SILO TRANSFER
120	DIVERTER BOX TO #2 SILO TRANSFER
121	DIVERTER BOX TO #8 SILO TRANSFER
122	TURNHEAD TO #7 SILO TRANSFER
123	TURNHEAD TO #12 SILO TRANSFER
124	TURNHEAD TO #11 SILO TRANSFER
125	TURNHEAD TO #10 SILO TRANSFER
126	DIVERTER BOX TO SHALE BELT TRANSFER
127	DIVERTER BOX TO SAND BELT TRANSFER
128	SAND BELT TO #3 SILO TRANSFER
129	#8 BELT TO #9 BELT TRANSFER
130	#9 BELT TO #6 SILO TRANSFER
131	CLINKER BELT TO CLINKER SILO TRANSFER
132	TURNHEAD TO STOKER COAL SILO TRANSFER
133	DIVERTER BOX TO #9 SILO TRANSFER
134	SHALE BELT TO SHALE SILO TRANSFER
135	TURNHEAD TO IRON SILO TRANSFER
136	#1 SILO FEEDER
137	#2 SILO FEEDER
138	#3 SILO FEEDER
139	#8 SILO FEEDER
140	IRON SILO #1 FEEDER
141	IRON SILO #2 FEEDER
142	#6 SILO TRANSFER
143	#7 SILO FEEDER
144	#12 SILO FEEDER
145	#11 SILO FEEDER
146	#10 SILO FEEDER
147	CLINKER SILO FEEDER
148	#9 SILO #1 FEEDER
149	#9 SILO #2 FEEDER
150	#7 BELT TO CLINKER SILO TRANSFER
151	#5 SILO FEEDER
152	#1 SHALE FEEDER



SECTION E. Source Group Restrictions.

153	#2 SHALE FEEDER
154	#3 SHALE FEEDER
155	#1 RAW MILL FEED BELT
156	#2 SHALE BELT TO #2 RAW MILL FEED BELT
157	#2 RAW MILL FEED BELT
158	#3 SHALE BELT TO #3 RAW MILL FEED BELT
159	#3 RAW MILL FEED BELT
160	#1 FINISH MILL FEED ELEVATOR
161	TURNHEAD TO #5 COAL BELT TRANSFER
162	DIVERTER BOX TO #2 COAL TANK TRANSFER
163	DIVERTER BOX TO COAL BELT TRANSFER
164	COAL BELT TO #1 COAL TANK TRANSFER
165	COAL BELT TO #3 COAL TANK TRANSFER
166	TURNHEAD TO GYPSUM BELT TRANSFER
167	KILN DUST (EARTH PLUS) LOADING
168	3101 BELT TO CLINKER PILE TRANSFER
169	REMOVAL FROM CLINKER PILE
170	GRAVEL BED FILTER DUST TRUCK TRANSFER
171	#3 KILN DUST REFEED
172	#2 FINISH MILL FEED BELT
173	FEEDER TO #1 KILN FEED ELEVATOR TRANSFER
174	FEEDER TO #2 KILN FEED ELEVATOR TRANSFER
175	EAST/WEST TRUCK LOADING #1
176	EAST/WEST TRUCK LOADING #2
177	NEW TRUCK LOADING
178	RAIL LOADING
179	CLINKER DOME FEEDER TRANSFER
198	TRANSFER STATION
199	3101 BELT & 3102 BELT
200	GRAVEL BED FILTER DUST SILO
201	KILN DUST (EARTH PLUS) TANK
202	3104 BELT & 3105 BELT
203	CLINKER STORAGE BUILDING
204	CLINKER DOME AND TUNNEL
205	#1 & #2 KILN FEED ELEVATOR
206	#1 & #3 HOMOGENIZING SILOS
207	#5 HOMOGENIZING SILO
208	SURGE BIN
209	EAST CEMENT SILOS
210	WEST CEMENT SILOS
211	#1 - #4 CEMENT SILOS
212	MASONRY CEMENT SILO
213	SOUTH PACKER



SECTION E. Source Group Restrictions.

214	NORTH PACKER
215	MASONRY PACKER
216	EAST/WEST TRUCK LOADING
217	NEW TRUCK LOADING
218	RAILCAR LOADING
220	3103 BELT & 3104 BELT
221	KILN DUST (EARTH PLUS) SILOS
241	SLAG HOPPER TO SLAG BELT 1A TRANSFER
242	SLAG HOPPER TO SLAG BELT 2A TRANSFER
243	SLAG HOPPER TO SLAG BELT 3A TRANSFER
244	SLAG BELT 1A TO SLAG BELT 1B TRANSFER
245	SLAG BELT 1B TO SLAG BELT 1C TRANSFER
246	SLAG BELT 2A TO SLAG BELT 2B TRANSFER
247	SLAG BELT 2B TO SLAG BELT 2C TRANSFER
248	SLAG BELT 3A TO SLAG BELT 3B TRANSFER
249	SLAG BELT 3B TO SLAG BELT 3C TRANSFER

I. RESTRICTIONS.

Emission Restriction(s).

001 [25 Pa. Code §127.441]

Operating permit terms and conditions.

§ 63.1345 Emissions limits for affected sources other than kilns; in-line kiln/raw mills; clinker coolers; new and reconstructed raw material dryers; and raw and finish mills, and open clinker piles.

The owner or operator of each new or existing raw material, clinker, or finished product storage bin; conveying system transfer point; bagging system; and bulk loading or unloading system; and each existing raw material dryer, at a facility which is a major source subject to the provisions of this subpart must not cause to be discharged any gases from these affected sources which exhibit opacity in excess of ten percent.

[75 FR 55054, Sept. 9, 2010]

002 [25 Pa. Code §127.441]

Operating permit terms and conditions.

§ 63.1348 Compliance requirements.

The permittee shall comply with the applicable performance testing requirements of 40 CFR 63.1348 [See Section C, Additional Requirements], as identified below:

(a) Applicable

- (1) Not Applicable
- (2) Applicable
- (3) - (6) Not Applicable

(b) Applicable

- (1) - (2) Not Applicable

**SECTION E. Source Group Restrictions.**

- (3) Applicable
- (4) - (8) Not Applicable
- (c) - (d) Applicable

II. TESTING REQUIREMENTS.

003 [40 CFR Part 63 NESHAPS for Source Categories §40 CFR 63.1349]
 Subpart LLL -- National Emission Standards for Hazardous Air Pollutants From the Portland Cement Manufacturing Industry
 Performance testing requirements.

The permittee shall comply with the applicable performance testing requirements of 40 CFR 63.1349 [See Section C, Additional Requirements], as identified below:

- (a) Applicable.
- (b) Applicable.
 - (1) Not Applicable.
 - (2) Applicable.
 - (3) - (6) Not Applicable.
- (c) Not Applicable.
- (d) Applicable.
- (e) Applicable.

III. MONITORING REQUIREMENTS.

004 [40 CFR Part 63 NESHAPS for Source Categories §40 CFR 63.1350]
 Subpart LLL -- National Emission Standards for Hazardous Air Pollutants From the Portland Cement Manufacturing Industry
 Monitoring requirements.

The permittee shall comply with the applicable Monitoring requirements of 40 CFR 63.1350 [See Section C, Additional Requirements], as identified below:

- (a) Applicable.
- (b) Not Applicable.
- (c) Reserved.
- (d) Not applicable.
- (e) Reserved.
- (f) Applicable.
- (g) - (p) Not applicable.

IV. RECORDKEEPING REQUIREMENTS.

005 [40 CFR Part 63 NESHAPS for Source Categories §40 CFR 63.1355]
 Subpart LLL -- National Emission Standards for Hazardous Air Pollutants From the Portland Cement Manufacturing Industry
 Recordkeeping requirements.

**SECTION E. Source Group Restrictions.**

The permittee shall comply with the applicable Recordkeeping requirements of 40 CFR 63.1355 [See Section C, Additional Requirements], as identified below:

- (a) - (c) Applicable.
- (d) - (e) Not Applicable.
- (f) - (g) Applicable.

V. REPORTING REQUIREMENTS.

006 [40 CFR Part 63 NESHAPS for Source Categories §40 CFR 63.1353]

Subpart LLL -- National Emission Standards for Hazardous Air Pollutants From the Portland Cement Manufacturing Industry

Notification requirements.

The permittee shall comply with the applicable Notification requirements of 40 CFR 63.1353 [See Section C, Additional Requirements], as identified below:

- (a) Applicable.
- (b) Applicable.

007 [40 CFR Part 63 NESHAPS for Source Categories §40 CFR 63.1354]

Subpart LLL -- National Emission Standards for Hazardous Air Pollutants From the Portland Cement Manufacturing Industry

Reporting requirements.

The permittee shall comply with the applicable Reporting requirements of 40 CFR 63.1354 [See Section C, Additional Requirements], as identified below:

- (a) Applicable.
- (b) Applicable.
- (c) Applicable.

VI. WORK PRACTICE REQUIREMENTS.

No additional work practice requirements exist except as provided in other sections of this permit including Section B (Title V General Requirements).

VII. ADDITIONAL REQUIREMENTS.

No additional requirements exist except as provided in other sections of this permit including Section B (Title V General Requirements).

*** Permit Shield in Effect. ***

**SECTION E. Source Group Restrictions.**

Group Name: 6 - RAW MATERIAL DRYERS W/NESHAP REQ.

Group Description:

Sources included in this group:

ID	Name
232	#1 RAW MILL FURNACE
233	#2 RAW MILL FURNACE

I. RESTRICTIONS.**Emission Restriction(s).**

001 [25 Pa. Code §123.13]

Processes

No person may permit the emission into the outdoor atmosphere of particulate matter from any process in a manner that the concentration of particulate matter in the effluent gas exceeds .04 grain per dry standard cubic foot, when the effluent gas volume is less than 150,000 dry standard cubic feet per minute.

002 [25 Pa. Code §123.21]

General

No person may permit the emission into the outdoor atmosphere of sulfur oxides from a source in a manner that the concentration of the sulfur oxides, expressed as SO₂, in the effluent gas exceeds 500 parts per million, by volume, dry basis.

II. TESTING REQUIREMENTS.

003 [25 Pa. Code §127.511]

Monitoring and related recordkeeping and reporting requirements.

The owner or operator shall, at a minimum, obtain one of the following:

- A fuel analysis of the btu value using ASTM method D2015-77 or a comparable ASTM Method, moisture, ash, and sulfur content (% by weight) using ASTM method D3178-74, D3176, or a comparable ASTM Method conducted on a representative weekly composite coal sample. If coal shipments are received beyond a weekly schedule, the fuel analysis shall be done on the shipment, as received.
- Written certification from the supplier, signed by a responsible official, which certifies the aforesaid fuel characteristics for coal delivered to the facility.

III. MONITORING REQUIREMENTS.

No additional monitoring requirements exist except as provided in other sections of this permit including Section B (Title V General Requirements).

IV. RECORDKEEPING REQUIREMENTS.

No additional record keeping requirements exist except as provided in other sections of this permit including Section B (Title V General Requirements).

V. REPORTING REQUIREMENTS.

No additional reporting requirements exist except as provided in other sections of this permit including Section B (Title V General Requirements).

VI. WORK PRACTICE REQUIREMENTS.

004 [25 Pa. Code §127.511]

Monitoring and related recordkeeping and reporting requirements.

- The permittee shall calculate the SO_x emissions (lb/mmmbtu), expressed as SO₂, whenever the sulfur in the coal is greater than 2.25% by weight based on either the coal certifications received or coal testing performed.
- The source shall be operated and maintained in accordance with the manufacturer's specifications and in accordance with

SECTION E. Source Group Restrictions.

good air pollution control practices.

005 [25 Pa. Code §127.511]

Monitoring and related recordkeeping and reporting requirements.

All emissions from each furnace shall be directed to the atmosphere through the raw mills (Sources 195, 196, and 197) and the control equipment associated with the raw mills.

VII. ADDITIONAL REQUIREMENTS.

No additional requirements exist except as provided in other sections of this permit including Section B (Title V General Requirements).

*** Permit Shield in Effect. ***

**SECTION E. Source Group Restrictions.**

Group Name: 7 - KILN AUXILARY MOTORS

Group Description:

Sources included in this group:

ID	Name
229	#1 KILN AUXILLIARY MOTOR
230	#2 KILN AUXILLIARY MOTOR
231	#3 KILN AUXILLIARY MOTOR

I. RESTRICTIONS.**Emission Restriction(s).**

001 [25 Pa. Code §123.13]

Processes

No person may permit the emission into the outdoor atmosphere of particulate matter from any process in a manner that the concentration of particulate matter in the effluent gas exceeds .04 grain per dry standard cubic foot, when the effluent gas volume is less than 150,000 dry standard cubic feet per minute.

002 [25 Pa. Code §123.21]

General

No person may permit the emission into the outdoor atmosphere of sulfur oxides from a source in a manner that the concentration of the sulfur oxides, expressed as SO₂, in the effluent gas exceeds 500 parts per million, by volume, dry basis.

Fuel Restriction(s).

003 [25 Pa. Code §127.511]

Monitoring and related recordkeeping and reporting requirements.

The permittee shall only use propane as a fuel for each auxiliary kiln motor.

II. TESTING REQUIREMENTS.

No additional testing requirements exist except as provided in other sections of this permit including Section B (Title V General Requirements).

III. MONITORING REQUIREMENTS.

No additional monitoring requirements exist except as provided in other sections of this permit including Section B (Title V General Requirements).

IV. RECORDKEEPING REQUIREMENTS.

004 [40 CFR Part 63 NESHAPS for Source Categories §40 CFR 63.6655]

Subpart ZZZZ - National Emissions Standards for Hazardous Air Pollutants for Stationary Reciprocating Internal Combustion Engines**What records must I keep?**

(a) If you must comply with the emission and operating limitations, you must keep the records described in paragraphs (a)(1) through (a)(5), (b)(1) through (b)(3) and (c) of this section.

(1) A copy of each notification and report that you submitted to comply with this subpart, including all documentation supporting any Initial Notification or Notification of Compliance Status that you submitted, according to the requirement in §63.10(b)(2)(xiv).

(2) Records of the occurrence and duration of each malfunction of operation (i.e., process equipment) or the air pollution control and monitoring equipment.

(3) Not applicable

(4) Records of all required maintenance performed on the air pollution control and monitoring equipment.

**SECTION E. Source Group Restrictions.**

(5) Records of actions taken during periods of malfunction to minimize emissions in accordance with §63.6605(b), including corrective actions to restore malfunctioning process and air pollution control and monitoring equipment to its normal or usual manner of operation.

b) Not applicable

c) Not applicable

(d) You must keep the records required in Table 6 of this subpart to show continuous compliance with each emission or operating limitation that applies to you.

(e) You must keep records of the maintenance conducted on the stationary RICE in order to demonstrate that you operated and maintained the stationary RICE and after-treatment control device (if any) according to your own maintenance plan if you own or operate any of the following stationary RICE:

(1) An existing stationary RICE with a site rating of less than 100 brake HP located at a major source of HAP emissions.

(2) An existing stationary emergency RICE.

(3) Not applicable

(f) If you own or operate any of the stationary RICE in paragraphs (f)(1) or (2) of this section, you must keep records of the hours of operation of the engine that is recorded through the non-resettable hour meter. The owner or operator must document how many hours are spent for emergency operation, including what classified the operation as emergency and how many hours are spent for non-emergency operation. If the engines are used for demand response operation, the owner or operator must keep records of the notification of the emergency situation, and the time the engine was operated as part of demand response.

(1) An existing emergency stationary RICE with a site rating of less than or equal to 500 brake HP located at a major source of HAP emissions that does not meet the standards applicable to non-emergency engines.

005 [40 CFR Part 63 NESHAPS for Source Categories §40 CFR 63.6660]

Subpart ZZZZ - National Emissions Standards for Hazardous Air Pollutants for Stationary Reciprocating Internal Combustion Engines

In what form and how long must I keep my records?

(a) Your records must be in a form suitable and readily available for expeditious review according to §63.10(b)(1).

(b) As specified in §63.10(b)(1), you must keep each record for 5 years following the date of each occurrence, measurement, maintenance, corrective action, report, or record.

(c) You must keep each record readily accessible in hard copy or electronic form for at least 5 years after the date of each occurrence, measurement, maintenance, corrective action, report, or record, according to §63.10(b)(1).

V. REPORTING REQUIREMENTS.

006 [40 CFR Part 63 NESHAPS for Source Categories §40 CFR 63.6630]

Subpart ZZZZ - National Emissions Standards for Hazardous Air Pollutants for Stationary Reciprocating Internal Combustion Engines

How do I demonstrate initial compliance with the emission limitations and operating limitations?

(c) You must submit the Notification of Compliance Status containing the results of the initial compliance demonstration according to the requirements in §63.6645.

007 [40 CFR Part 63 NESHAPS for Source Categories §40 CFR 63.6640]

Subpart ZZZZ - National Emissions Standards for Hazardous Air Pollutants for Stationary Reciprocating Internal Combustion Engines

How do I demonstrate continuous compliance with the emission limitations and operating limitations?

(b) You must report each instance in which you did not meet each emission limitation or operating limitation in Tables 1a and 1b, Tables 2a and 2b, Table 2c, and Table 2d to this subpart that apply to you. These instances are deviations from the emission



SECTION E. Source Group Restrictions.

and operating limitations in this subpart. These deviations must be reported according to the requirements in §63.6650. If you change your catalyst, you must reestablish the values of the operating parameters measured during the initial performance test. When you reestablish the values of your operating parameters, you must also conduct a performance test to demonstrate that you are meeting the required emission limitation applicable to your stationary RICE.

008 [40 CFR Part 63 NESHAPS for Source Categories §40 CFR 63.6640]

Subpart ZZZZ - National Emissions Standards for Hazardous Air Pollutants for Stationary Reciprocating Internal Combustion Engines

How do I demonstrate continuous compliance with the emission limitations and operating limitations?

e) You must also report each instance in which you did not meet the requirements in Table 8 to this subpart that apply to you.

009 [40 CFR Part 63 NESHAPS for Source Categories §40 CFR 63.6645]

Subpart ZZZZ - National Emissions Standards for Hazardous Air Pollutants for Stationary Reciprocating Internal Combustion Engines

What notifications must I submit and when?

(d) As specified in §63.9(b)(2), if you start up your stationary RICE with a site rating of equal to or less than 500 brake HP located at a major source of HAP emissions before the effective date of this subpart and you are required to submit an initial notification, you must submit an Initial Notification not later than July 16, 2008.

VI. WORK PRACTICE REQUIREMENTS.

010 [25 Pa. Code §127.511]

Monitoring and related recordkeeping and reporting requirements.

The permittee shall maintain and operate this source in accordance with the manufacturer's specifications and good air pollution control practices.

011 [40 CFR Part 63 NESHAPS for Source Categories §40 CFR 63.6602]

Subpart ZZZZ - National Emissions Standards for Hazardous Air Pollutants for Stationary Reciprocating Internal Combustion Engines

What emission limitations must I meet if I own or operate an existing stationary RICE with a site rating of equal to or less than 500 brake HP located at a major source of HAP emissions?

If you own or operate an existing stationary RICE with a site rating of equal to or less than 500 brake HP located at a major source of HAP emissions, you must comply with the emission limitations in Table 2c to this subpart which apply to you. Compliance with the numerical emission limitations established in this subpart is based on the results of testing the average of three 1-hour runs using the testing requirements and procedures in §63.6620 and Table 4 to this subpart.

[Table 2c excerpt - Emergency stationary CI RICE - must:

- a. Change oil and filter every 500 hours of operation or annually, whichever comes first;
- b. Inspect air cleaner every 1,000 hours of operation or annually, whichever comes first;
- c. Inspect all hoses and belts every 500 hours of operation or annually, whichever comes first, and replace as necessary.

During periods of startup you must : Minimize the engine's time spent at idle and minimize the engine's startup time at startup to a period needed for appropriate and safe loading of the engine, not to exceed 30 minutes, after which time the non-startup emission limitations apply.]

Footnotes: Sources have the option to utilize an oil analysis program as described in §63.6625(i) in order to extend the specified oil change requirement in Table 2c of this subpart.

Sources can petition the Administrator pursuant to the requirements of 40 CFR 63.6(g) for alternative work practices.

012 [40 CFR Part 63 NESHAPS for Source Categories §40 CFR 63.6605]

Subpart ZZZZ - National Emissions Standards for Hazardous Air Pollutants for Stationary Reciprocating Internal Combustion Engines

What are my general requirements for complying with this subpart?

(a) You must be in compliance with the emission limitations and operating limitations in this subpart that apply to you at all times.

(b) At all times you must operate and maintain any affected source, including associated air pollution control equipment and monitoring equipment, in a manner consistent with safety and good air pollution control practices for minimizing emissions. The general duty to minimize emissions does not require you to make any further efforts to reduce emissions if levels



SECTION E. Source Group Restrictions.

required by this standard have been achieved. Determination of whether such operation and maintenance procedures are being used will be based on information available to the Administrator which may include, but is not limited to, monitoring results, review of operation and maintenance procedures, review of operation and maintenance records, and inspection of the source.

013 [40 CFR Part 63 NESHAPS for Source Categories §40 CFR 63.6625]

Subpart ZZZZ - National Emissions Standards for Hazardous Air Pollutants for Stationary Reciprocating Internal Combustion Engines

What are my monitoring, installation, operation, and maintenance requirements?

(e) If you own or operate any of the following stationary RICE, you must operate and maintain the stationary RICE and after-treatment control device (if any) according to the manufacturer's emission-related written instructions or develop your own maintenance plan which must provide to the extent practicable for the maintenance and operation of the engine in a manner consistent with good air pollution control practice for minimizing emissions:

(1) An existing stationary RICE with a site rating of less than 100 HP located at a major source of HAP emissions;

(2) An existing emergency or black start stationary RICE with a site rating of less than or equal to 500 HP located at a major source of HAP emissions

014 [40 CFR Part 63 NESHAPS for Source Categories §40 CFR 63.6625]

Subpart ZZZZ - National Emissions Standards for Hazardous Air Pollutants for Stationary Reciprocating Internal Combustion Engines

What are my monitoring, installation, operation, and maintenance requirements?

(f) If you own or operate an existing emergency stationary RICE with a site rating of less than or equal to 500 brake HP located at a major source of HAP emissions or an existing emergency stationary RICE located at an area source of HAP emissions, you must install a non-resettable hour meter if one is not already installed.

015 [40 CFR Part 63 NESHAPS for Source Categories §40 CFR 63.6625]

Subpart ZZZZ - National Emissions Standards for Hazardous Air Pollutants for Stationary Reciprocating Internal Combustion Engines

What are my monitoring, installation, operation, and maintenance requirements?

(h) If you operate a new, reconstructed, or existing stationary engine, you must minimize the engine's time spent at idle during startup and minimize the engine's startup time to a period needed for appropriate and safe loading of the engine, not to exceed 30 minutes, after which time the emission standards applicable to all times other than startup in Tables 1a, 2a, 2c, and 2d to this subpart apply.

016 [40 CFR Part 63 NESHAPS for Source Categories §40 CFR 63.6625]

Subpart ZZZZ - National Emissions Standards for Hazardous Air Pollutants for Stationary Reciprocating Internal Combustion Engines

What are my monitoring, installation, operation, and maintenance requirements?

(i) If you own or operate a stationary CI engine that is subject to the work, operation or management practices in items 1 or 2 of Table 2c to this subpart or in items 1 or 4 of Table 2d to this subpart, you have the option of utilizing an oil analysis program in order to extend the specified oil change requirement in Tables 2c and 2d to this subpart. The oil analysis must be performed at the same frequency specified for changing the oil in Table 2c or 2d to this subpart. The analysis program must at a minimum analyze the following three parameters: Total Base Number, viscosity, and percent water content. The condemning limits for these parameters are as follows: Total Base Number is less than 30 percent of the Total Base Number of the oil when new; viscosity of the oil has changed by more than 20 percent from the viscosity of the oil when new; or percent water content (by volume) is greater than 0.5. If all of these condemning limits are not exceeded, the engine owner or operator is not required to change the oil. If any of the limits are exceeded, the engine owner or operator must change the oil within 2 days of receiving the results of the analysis; if the engine is not in operation when the results of the analysis are received, the engine owner or operator must change the oil within 2 days or before commencing operation, whichever is later. The owner or operator must keep records of the parameters that are analyzed as part of the program, the results of the analysis, and the oil changes for the engine. The analysis program must be part of the maintenance plan for the engine.

**SECTION E. Source Group Restrictions.**

017 [40 CFR Part 63 NESHAPS for Source Categories §40 CFR 63.6640]

Subpart ZZZZ - National Emissions Standards for Hazardous Air Pollutants for Stationary Reciprocating Internal Combustion Engines

How do I demonstrate continuous compliance with the emission limitations and operating limitations?

(f) Requirements for emergency stationary RICE.

(1) If you own or operate an existing emergency stationary RICE with a site rating of less than or equal to 500 brake HP located at a major source of HAP emissions, a new or reconstructed emergency stationary RICE with a site rating of more than 500 brake HP located at a major source of HAP emissions that was installed on or after June 12, 2006, or an existing emergency stationary RICE located at an area source of HAP emissions, you must operate the emergency stationary RICE according to the requirements in paragraphs (f)(1)(i) through (iii) of this section. Any operation other than emergency operation, maintenance and testing, and operation in non-emergency situations for 50 hours per year, as described in paragraphs (f)(1)(i) through (iii) of this section, is prohibited. If you do not operate the engine according to the requirements in paragraphs (f)(1)(i) through (iii) of this section, the engine will not be considered an emergency engine under this subpart and will need to meet all requirements for non-emergency engines.

(i) There is no time limit on the use of emergency stationary RICE in emergency situations.

(ii) You may operate your emergency stationary RICE for the purpose of maintenance checks and readiness testing, provided that the tests are recommended by Federal, State or local government, the manufacturer, the vendor, or the insurance company associated with the engine. Maintenance checks and readiness testing of such units is limited to 100 hours per year. The owner or operator may petition the Administrator for approval of additional hours to be used for maintenance checks and readiness testing, but a petition is not required if the owner or operator maintains records indicating that Federal, State, or local standards require maintenance and testing of emergency RICE beyond 100 hours per year.

(iii) You may operate your emergency stationary RICE up to 50 hours per year in non-emergency situations, but those 50 hours are counted towards the 100 hours per year provided for maintenance and testing. The 50 hours per year for non-emergency situations cannot be used for peak shaving or to generate income for a facility to supply power to an electric grid or otherwise supply power as part of a financial arrangement with another entity; except that owners and operators may operate the emergency engine for a maximum of 15 hours per year as part of a demand response program if the regional transmission organization or equivalent balancing authority and transmission operator has determined there are emergency conditions that could lead to a potential electrical blackout, such as unusually low frequency, equipment overload, capacity or energy deficiency, or unacceptable voltage level. The engine may not be operated for more than 30 minutes prior to the time when the emergency condition is expected to occur, and the engine operation must be terminated immediately after the facility is notified that the emergency condition is no longer imminent. The 15 hours per year of demand response operation are counted as part of the 50 hours of operation per year provided for non-emergency situations. The supply of emergency power to another entity or entities pursuant to financial arrangement is not limited by this paragraph (f)(1)(iii), as long as the power provided by the financial arrangement is limited to emergency power.

VII. ADDITIONAL REQUIREMENTS.

018 [40 CFR Part 63 NESHAPS for Source Categories §40 CFR 63.6590]

Subpart ZZZZ - National Emissions Standards for Hazardous Air Pollutants for Stationary Reciprocating Internal Combustion Engines

What parts of my plant does this subpart cover?

This subpart applies to each affected source.

(a) Affected source. An affected source is any existing, new, or reconstructed stationary RICE located at a major or area source of HAP emissions, excluding stationary RICE being tested at a stationary RICE test cell/stand.

(1) Existing stationary RICE.

(i) Not applicable

(ii) For stationary RICE with a site rating of less than or equal to 500 brake HP located at a major source of HAP emissions, a stationary RICE is existing if you commenced construction or reconstruction of the stationary RICE before June 12, 2006.



SECTION E. Source Group Restrictions.

019 [40 CFR Part 63 NESHAPS for Source Categories §40 CFR 63.6595]

Subpart ZZZZ - National Emissions Standards for Hazardous Air Pollutants for Stationary Reciprocating Internal Combustion Engines

When do I have to comply with this subpart?

(a) Affected sources. (1) If you have an existing stationary RICE, excluding existing non-emergency CI stationary RICE, with a site rating of more than 500 brake HP located at a major source of HAP emissions, you must comply with the applicable emission limitations and operating limitations no later than June 15, 2007. If you have an existing non-emergency CI stationary RICE with a site rating of more than 500 brake HP located at a major source of HAP emissions, an existing stationary CI RICE with a site rating of less than or equal to 500 brake HP located at a major source of HAP emissions, or an existing stationary CI RICE located at an area source of HAP emissions, you must comply with the applicable emission limitations and operating limitations no later than May 3, 2013. If you have an existing stationary SI RICE with a site rating of less than or equal to 500 brake HP located at a major source of HAP emissions, or an existing stationary SI RICE located at an area source of HAP emissions, you must comply with the applicable emission limitations and operating limitations no later than October 19, 2013.

020 [40 CFR Part 63 NESHAPS for Source Categories §40 CFR 63.6640]

Subpart ZZZZ - National Emissions Standards for Hazardous Air Pollutants for Stationary Reciprocating Internal Combustion Engines

How do I demonstrate continuous compliance with the emission limitations and operating limitations?

(a) You must demonstrate continuous compliance with each emission limitation and operating limitation in Tables 1a and 1b, Tables 2a and 2b, Table 2c, and Table 2d to this subpart that apply to you according to methods specified in Table 6 to this subpart.

021 [40 CFR Part 63 NESHAPS for Source Categories §40 CFR 63.6665]

Subpart ZZZZ - National Emissions Standards for Hazardous Air Pollutants for Stationary Reciprocating Internal Combustion Engines

What parts of the General Provisions apply to me?

Table 8 to this subpart shows which parts of the General Provisions in Sections 63.1 through 63.15 apply to you.

*** Permit Shield in Effect. ***



SECTION F. Alternative Operation Requirements.

No Alternative Operations exist for this Title V facility.



SECTION G. Emission Restriction Summary.

No emission restrictions listed in this section of the permit.



SECTION H. Miscellaneous.

- (a) The emission limitations listed in Section H of this permit are provided for informational purposes. The actual emission limits for each source are provided in Sections D and E of this permit.
- (b) The capacities listed in Section D of this permit are typical operational capacities and are included for informational purposes. The listed capacities are not to be construed as enforceable limits or maximum capacities. All enforceable limits that apply to any source included in this permit are included in the conditions of this permit.
- (c) The following sources have no applicable emissions limitations, testing, monitoring, recordkeeping, reporting, work practice or other applicable requirements:
- (1) Large Truck Fuel Tank (#2 oil)
 - (2) Small Truck Fuel Tank (#2 oil)
 - (3) Kiln Light Off Tank (#2 oil)
 - (4) Used Oil Tank #1
 - (5) Used Oil Tank #2
 - (6) Gasoline Storage Tank (500 Gallons)
- (d) The definitions, units of measurements, and abbreviations described in 40 CFR 63.2, 63.3 and 63.1341 shall be used to interpret any applicable requirement from 40 CFR Part 63 that are included in this permit.
- (e) A minor modification of this permit was completed on June 9, 2006 to remove the errant restriction on the percent sulfur and ash of activated carbon. In addition, several typographical errors were also corrected.
- (f) A minor modification of this permit was completed on March 5, 2007 to include Class A dried sewage sludge as fuel in kilns #1, #2, and #3 limited to 1.5 TPY. Requirements for Recordkeeping and Additional Requirements were added as part of this minor modification.
- (g) A minor modification of this permit was completed on May 20, 2008 to include Vexor non-hazardous engineered fuels as fuel in kilns #1, #2, and #3 limited to 3.6 ton per hour per kiln. Fuel testing (certification of the fuel as non-hazardous), Monitoring, and Recordkeeping Requirements were added as part of this minor modification.
- (h) This permit was renewed on February 16, 2012 with an expiration date of January 31, 2017. The renewal included the revisions to the 40 CFR 63 Subpart LLL MACT requirements and the Subpart ZZZZ MACT requirements.



***** End of Report *****

